



# 2026

ÜRÜN KATALOĞU  
PRODUCT CATALOGUE



**MBC**  
Cutting Tools

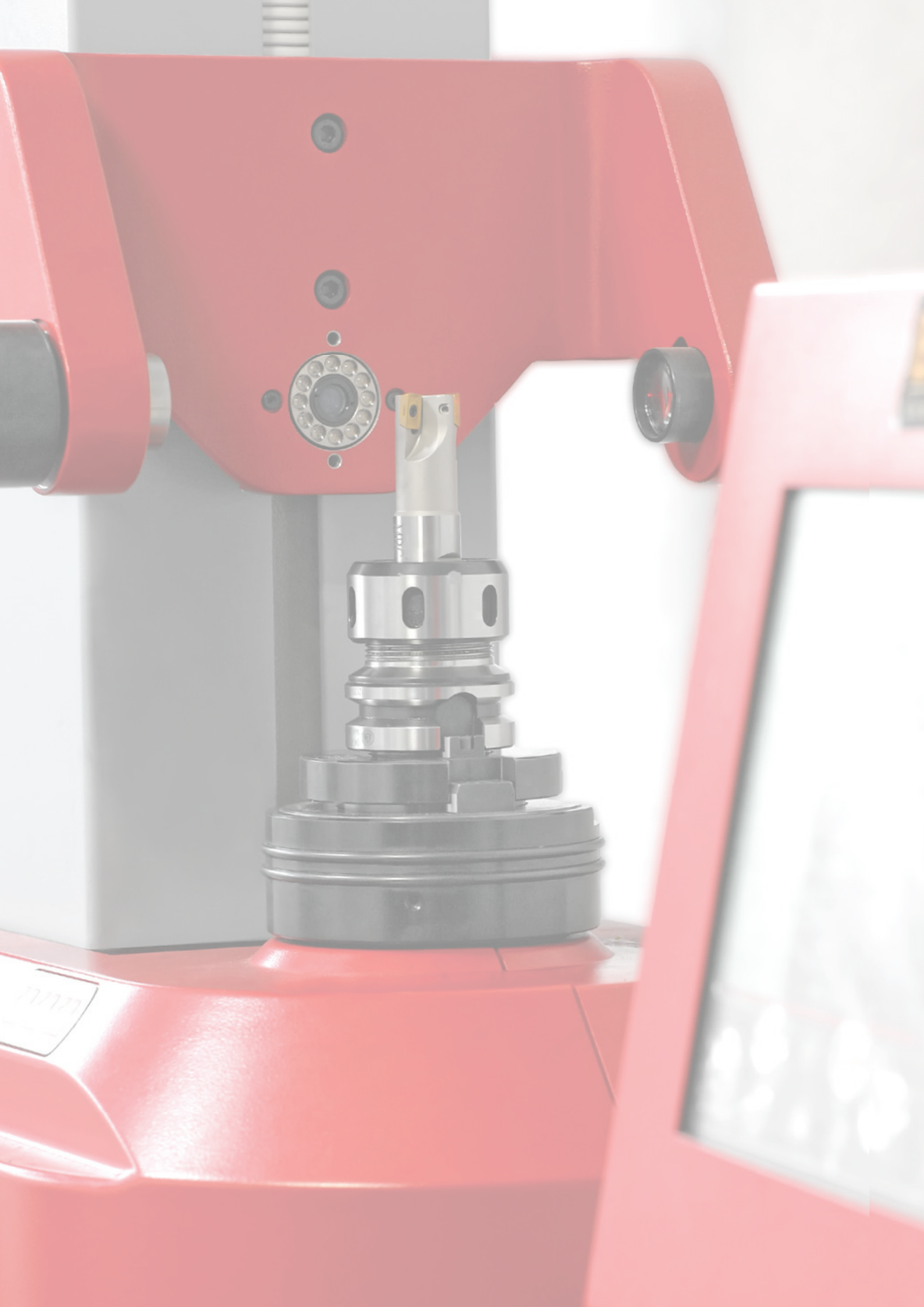



**“Siz üretirken biz destek oluyoruz”**  
*“We support while you produce”*





## *Misyonumuz*

Sürdürülebilir kalkınmayı kendimize yol haritası kabul ederek; çevreye duyarlı, en az maliyetle, paydaşlarımızın isteklerini karşılayan bir şirket olmaktır.

## *Our Mission*

To be a company which recognise sustainable development as a road map to us to meet the demands of our clients with environmentally sensitive with minimal cost.

# Vizyonumuz

Toplam kalite felsefesi ile Dünya Sanayisi'ne güvenilir, kaliteli ürün ve hizmet vermektir.

Müşteri istek ve ihtiyaçlarını tam olarak anlamak ve karşılamak, kalite yönetim sistemimizin gelişimini ve etkinliğini sağlayarak iç ve dış pazarda rekabet gücümüzü arttırmak, sürekli gelişmek için tüm çalışanların eğitimini ve katılımını sağlamak, ürün kalitemizi arttırmak ve maliyetlerimizi düşürmek.

Sektörümüzdeki teknolojik gelişmeleri yakından takip etmek ve bu gelişmeleri her alanda uygulamak.

## Vision







With the philosophy of total quality; serve the World Industrial Estate reliable and high quality products.

Understand exactly what the clients requests and needs; provide the development and effectiveness of our quality management system to increase our competitiveness in domestic and international market; to continuous development ensure the training and participation of all employees; improve the products quality and reduce the costs.

Follow the technological developments in our industry and implement these developments in all areas.

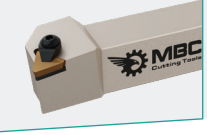
# İÇİNDEKİLER

## INDEX

sayfa/page 12-19	 <b>DIŞ KANAL KATERLERİ</b> EXTERNAL GROOVING TOOLHOLDERS	<b>P-SİSTEM İÇ ÇAP TORNALAMA KATERLERİ</b> P-SYSTEM INTERNAL TURNING TOOLHOLDERS	sayfa/page 73-74
sayfa/page 20-21	 <b>DIŞ KANAL KATERLERİ OTOMAT</b> EXTERNAL GROOVING TOOLHOLDERS AUTOMAT	<b>ŞAFTLI TARAMALAR</b> MILLING TOOLS	sayfa/page 76-111
sayfa/page 22-23	 <b>KESME TAKIMLARI</b> BLADE TOOLS	<b>ŞAFTLI TARAMALAR HIGH FEED</b> MILLING TOOLS HIGH FEED	sayfa/page 112-123
sayfa/page 25-29	 <b>İÇ KANAL KATERLERİ</b> INTERNAL GROOVING TOOLHOLDERS	<b>VİDALI TAKIM TUTUCULARI</b> SCREW TOOL HOLDERS	sayfa/page 124-125
sayfa/page 31-39	 <b>S-SİSTEM DIŞ ÇAP TORNALAMA KATERLERİ</b> S-SYSTEM EXTERNAL TURNING TOOLHOLDERS	<b>HIGH FEED FINISH TAKIMLARI</b> HIGH FEED FINISH TOOLS	sayfa/page 127
sayfa/page 41	 <b>C-SİSTEM DIŞ ÇAP TORNALAMA KATERLERİ</b> C-SYSTEM EXTERNAL TURNING TOOLHOLDERS	<b>FREZELEME TAKIMLARI</b> FACE MILLING	sayfa/page 129-132
sayfa/page 42-49	 <b>T-SİSTEM DIŞ ÇAP TORNALAMA KATERLERİ</b> T-SYSTEM EXTERNAL TURNING TOOLHOLDERS	<b>TARAMA KAFALARI</b> FACE MILLING	sayfa/page 134-181
sayfa/page 50-51	 <b>M-SİSTEM DIŞ ÇAP TORNALAMA KATERLERİ</b> M-SYSTEM EXTERNAL TURNING TOOLHOLDERS	<b>HIGH FEED TARAMA KAFALARI</b> HIGH FEED MILLINGS	sayfa/page 182-195
sayfa/page 52-53	 <b>P-SİSTEM DIŞ ÇAP TORNALAMA KATERLERİ</b> P-SYSTEM EXTERNAL TURNING TOOLHOLDERS	<b>VİDALI TARAMALAR</b> SCREW TYPE	sayfa/page 197-213
sayfa/page 55-66	 <b>S-SİSTEM İÇ ÇAP TORNALAMA KATERLERİ</b> S-SYSTEM INTERNAL TURNING TOOLHOLDERS	<b>U-DRILLER</b> U-DRILLS	sayfa/page 215-225
sayfa/page 68	 <b>C-SİSTEM İÇ ÇAP TORNALAMA KATERLERİ</b> C-SYSTEM INTERNAL TURNING TOOLHOLDERS	<b>KATERLER</b> CUTTING TOOLS	sayfa/page 226-228
sayfa/page 69-70	 <b>T-SİSTEM İÇ ÇAP TORNALAMA KATERLERİ</b> T-SYSTEM INTERNAL TURNING TOOLHOLDERS	<b>YUMUŞAK AYAKLAR</b> SOFT JAWS	sayfa/page 229
sayfa/page 71-72	 <b>M-SİSTEM İÇ ÇAP TORNALAMA KATERLERİ</b> M-SYSTEM INTERNAL TURNING TOOLHOLDERS	<b>YEDEK PARÇALAR</b> SPARE PARTS	sayfa/page 230-232

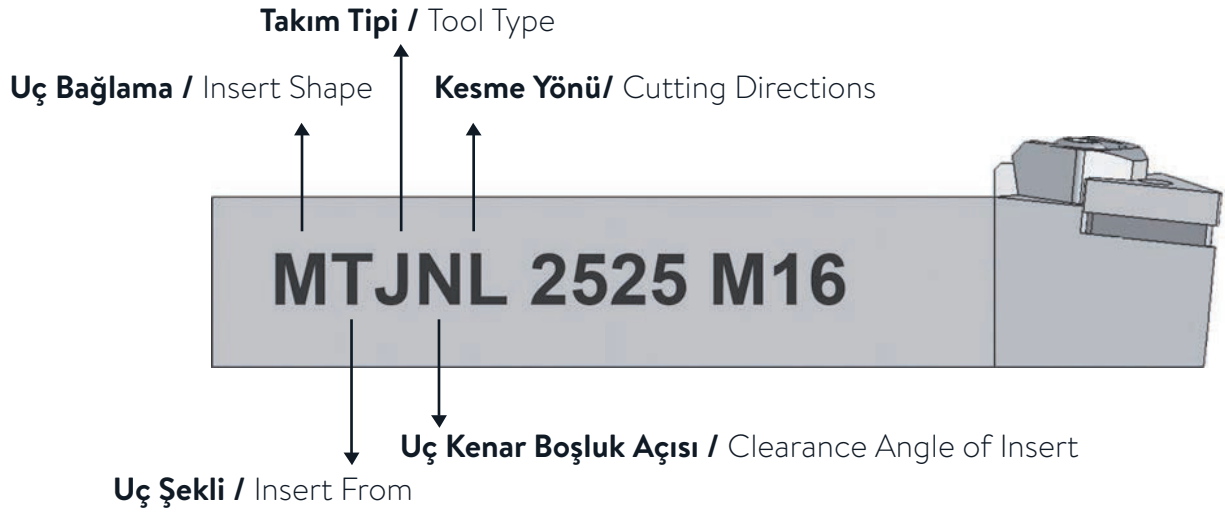

**Takım Tipi / Tool Type** ————— **Kesme Yönü / Cutting Directions**

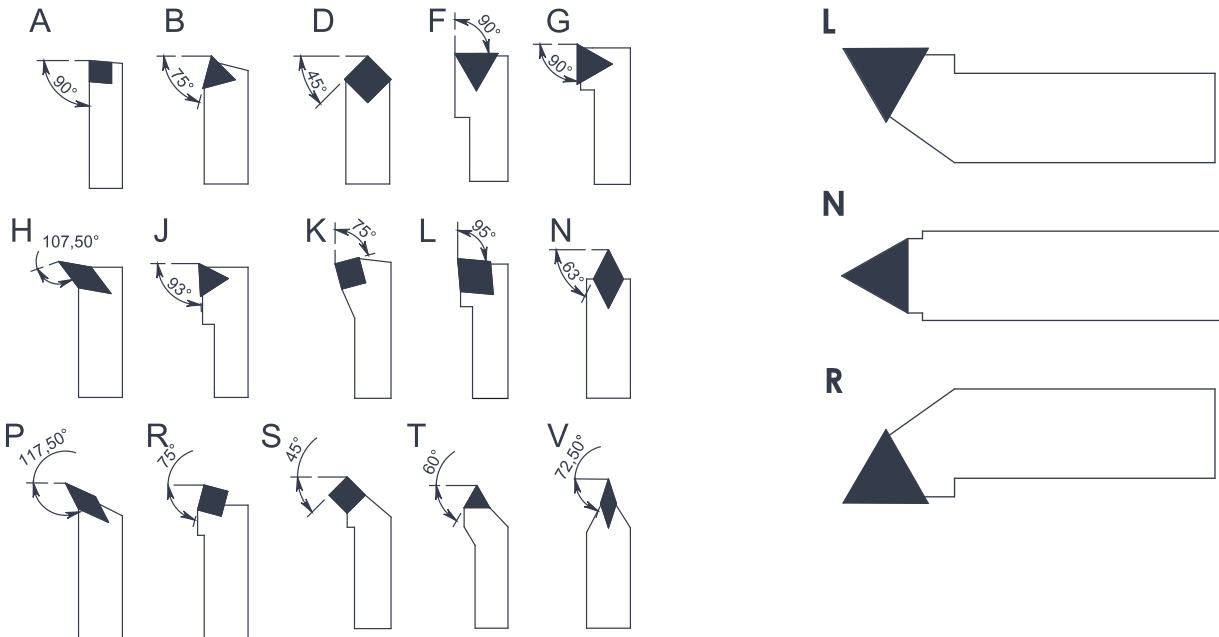

**Uç Şekli / Insert From** ————— **Uç Kenar Boşluk Açısı / Clearance Angle of Insert**

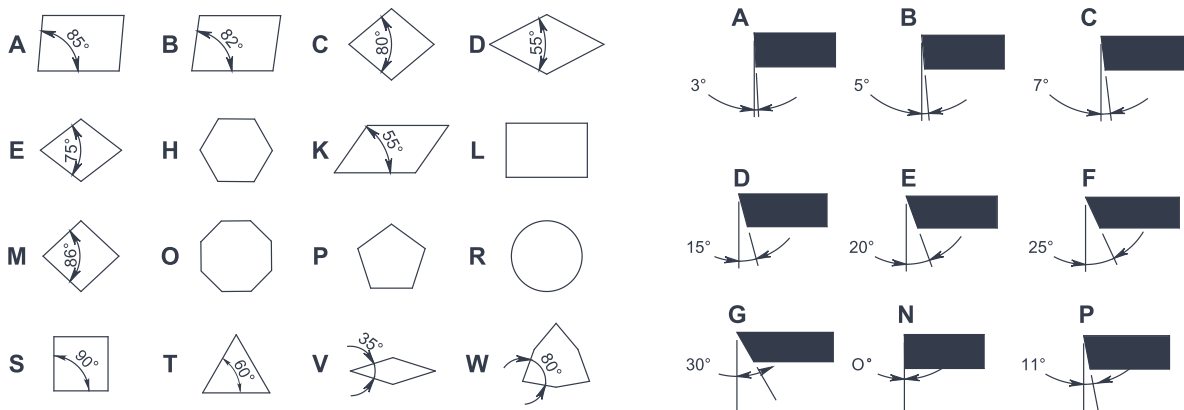

## M Sistem M System

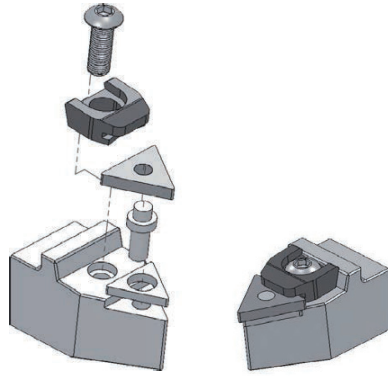

## S Sistem S System

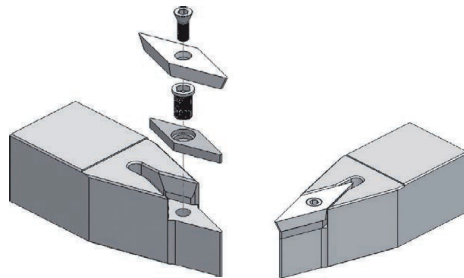

## T Sistem T System

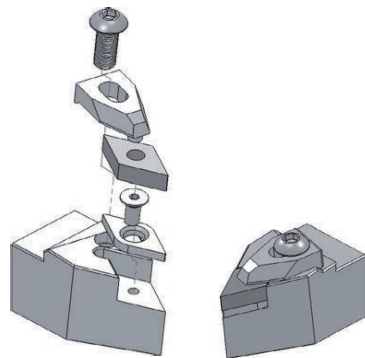

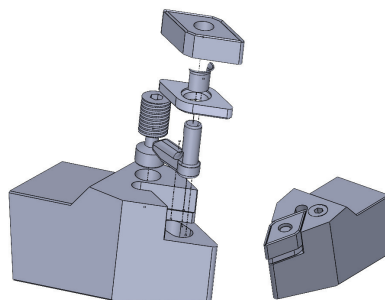

## P Sistem P System

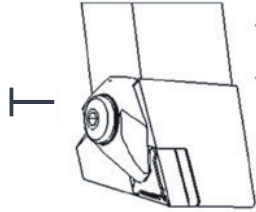
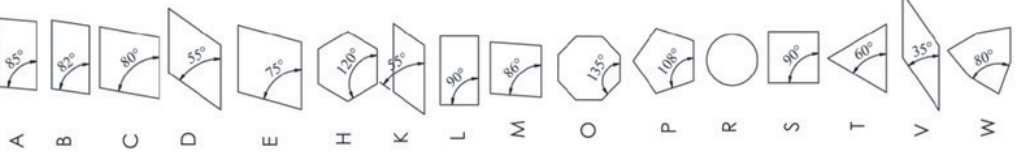
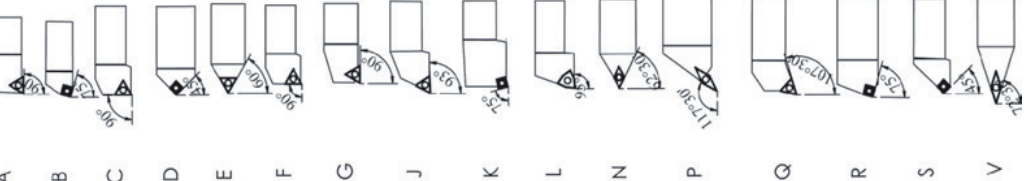
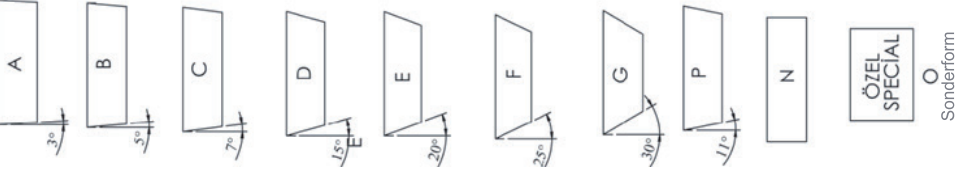

# DIŞ ÇAP KATERLERİ İÇİN ISO KODLARI

## EXTERNAL TURNING TOOLS ISO CODES

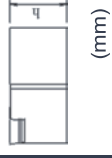
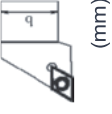
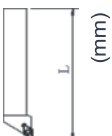
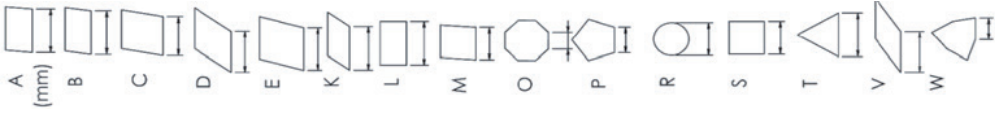
1	2	3	4	5	6	7	8	9
<b>T</b>	<b>D</b>	<b>J</b>	<b>N</b>	<b>R</b>	<b>20</b>	<b>20</b>	<b>K</b>	<b>15</b>
Uç Bağlama Sistemi Clamping System Klemmsystem	Kesici Uç Tipi Insert form WSP - Form	Kater Tipi Style Werkzeugtyp	Uç Açısı Clearance angle WSP-Freiwinkel	Kater Yönü Holder execution Bearbeitungs-richtung	Şaft Yüksekliği Height of shank Schaftquerschnitts	Şaft Genişliği Width of shank Schaftbreite	Takım Boyu Length of holder Werkzeuglänge	Uç Kenar Uzunluğu Length of cutting ed WSP-Größe
 T ÇEKİRMELİ M	 A B C D E H K L M O P R S T V W	 A B C D E F G J K L N P Q R S V	 A B C D E F G P N ÖZEL SPECIAL Sonderform	 L R N	 (mm) 06=6 08=8 10=10 12=12 14=14 16=16 20=20 22=22 25=25 32=32 40=40 50=50	 (mm) 06=6 08=8 10=10 12=12 14=14 16=16 20=20 22=22 25=25 32=32 40=40 50=50	 (mm) D=60 E=70 F=80 G=90 H=100 J=110 K=125 L=140 M=150 N=160 P=170 Q=180 R=200 S=250 T=300 U=350 V=400 W=450 Y=500 X=ÖZEL Special Sonderform	 A B C D E K L M O P R S T V W

**7**

**Uç Radüsü**  
Chamfer or Corner Radius  
Plattise oder Eckenradius

SEMBOL	R
00	0
02	0.2
04	0.4
08	0.8
12	1.2
16	1.6
24	2.4
32	3.2

**6**

**Uç Kalınlığı**  
Height of Cutting Edge  
Schneidkantenhöhe

SEMBOL	S
01	1.59
02	1.98
03	2.38
04	3.18
05	3.97
06	4.76
07	5.56
08	6.35
09	7.94
	9.52

**4**

**Kesici Delik Tipi**  
Type of Insert  
Plattentyp

**2**

**Uç Açısı**  
Clearance Angle  
Fraswinkel

**1**

**Kesici Uç Tipi**  
Shape  
Plattentform

**8 H R**

**7 08**

**6 06**

**4 G**

**3 M**

**2 N**

**1 D**

**5**

**Kesme Kenarı Şekli**  
Insert Forms  
WSP-Form

**Uç Formları**  
Insert Forms  
WSP-Form

**5**

**Kesme Kenar Uzunluğu**  
Length of Cutting Edge  
Schneidenlänge

**3**

**Uç Toleransları**  
Tolerance  
Toleranz

SEMBOL	Shape	Plattentform	m (±)	S (±)	d (±)
A			0,005	0,025	0,025
F			0,005	0,025	0,013
C			0,013	0,025	0,025
H			0,013	0,025	0,013
E			0,025	0,025	0,025
G			0,025	0,130	0,025
J			0,005	0,025	0,05-0,013
K			0,013	0,025	0,05-0,013
L			0,025	0,025	0,05-0,013
M			0,08-0,18	0,130	0,05-0,013
N			0,08-0,18	0,025	0,05-0,013
U			0,05-0,38	0,130	0,08-0,025



# DIŞ KANAL KATERLERİ

EXTERNAL GROOVING TOOLHOLDERS

#### DKT I

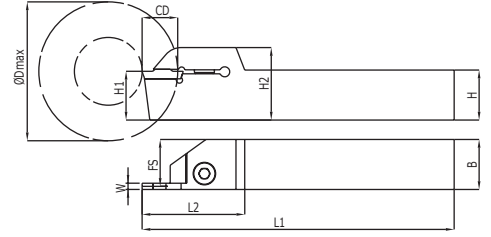

Kesici Uç Uyumluluğu Insert Suitability		Stok Stock	Takım Ölçüleri / Dimension (mm)									Uç Insert	Vida Screw	Anahtar Allen Key		
DKT I			Dmax	W	H	B	FS	L1	L2	H1	H2	CD				
SIPARIŞ KODU - R Ordering Code - R	SIPARIŞ KODU - L Ordering Code - L															
DKT 6976	DKT 6977	✓	62	2	12	12	11	90	31	12	24	14	DGN-2	M5X16	A4	
DKT 6992	DKT 6993	✓	62	3	12	12	10,5	90	31	12	24	14	DGN-3	M5X16	A4	
DKT 6981	DKT 6982	✓	62	2	16	16	15	125	43	16	28,5	18	DGN-2	M8X27	A4	
DKT 6996	DKT 6998	✓	62	3	16	16	14,5	125	43	16	28,5	18	DGN-3	M8X27	A4	
DKT 7006	DKT 7007	✓	62	4	16	16	14	125	43	16	28,5	18	DGN-4	M8X27	A4	
DKT 6986	DKT 6987	✓	62	2	20	20	19	125	43	20	28,5	18	DGN-2	M8X27	A4	
DKT 6999	DKT 7001	✓	62	3	20	20	18,5	125	43	20	28,5	18	DGN-3	M8X27	A4	
DKT 7008	DKT 7009	✓	62	4	20	20	18	125	43	20	28,5	18	DGN-4	M8X27	A4	
DKT 7013	x	✓	62	5	20	20	17,5	125	43	20	28,5	22	DGN-5	M8X27	A4	
DKT 6989	DKT 6990	✓	62	2	25	25	24	150	47	25	35	22	DGN-2	M8X27	A4	
DKT 7003	DKT 7004	✓	62	3	25	25	23,5	150	47	25	35	22	DGN-3	M8X27	A4	
DKT 7010	DKT 7011	✓	62	4	25	25	23	150	47	25	35	22	DGN-4	M8X27	A4	
DKT 7014	DKT 12332	✓	62	5	25	25	22,5	150	47	25	35	22	DGN-5	M8X27	A4	
DKT 7016	x	✓	62	6	25	25	22,5	150	47	25	35	22	DGN-6	M8X27	A4	
DKT 7005	x	✓	62	3	32	32	30,5	170	47	32	42	22	DGN-3	M8X27	A4	
DKT 7012	x	✓	62	4	32	32	30	170	47	32	42	22	DGN-4	M8X27	A4	
DKT 7015	x	✓	62	5	32	32	29,5	170	47	32	42	22	DGN-5	M8X27	A4	
DKT 7017	x	✓	62	6	32	32	29,5	170	47	32	42	22	DGN-6	M8X27	A4	
DKT 7018	x	✓	62	3	25	25	23,5	150	47	25	35	40	DGN-3	M8X27	A4	
DKT 7019	x	✓	62	4	25	25	23	150	47	25	35	40	DGN-4	M8X27	A4	

#### DKT K

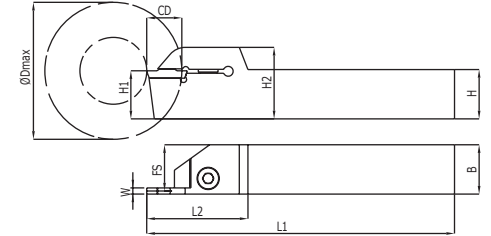

Kesici Uç Uyumluluğu Insert Suitability		Stok Stock	Takım Ölçüleri / Dimension (mm)									Uç Insert	Vida Screw	Anahtar Allen Key		
DKT K			Dmax	W	H	B	FS	L1	L2	H1	H2	CD				
SIPARIŞ KODU - R Ordering Code - R	SIPARIŞ KODU - L Ordering Code - L															
DKT 7027	DKT 7026	✓	62	2	12	12	11	90	31	12	24	14	MGM.2	M5X16	A4	
DKT 7036	DKT 7035	✓	62	3	12	12	10,5	90	31	12	24	14	MGM.3	M5X16	A4	
DKT 12852	x	✓	62	1,5	16	16	14,5	125	41	16	28,5	17	MGM.1,5	M8X27	A4	
DKT 7029	DKT 7028	✓	62	2	16	16	15	125	41	16	28,5	17	MGM.2	M8X27	A4	
DKT 7038	DKT 7037	✓	62	3	16	16	14,5	125	41	16	28,5	18	MGM.3	M8X27	A4	
DKT 7045	DKT 7044	✓	62	4	16	16	14	125	41	16	28,5	18	MGM.4	M8X27	A4	
DKT 14356	x	✓	62	5	16	16	13,5	125	41	16	28,5	18	MGM.5	M8X27	A4	
DKT 12921	x	✓	62	1,5	20	20	18,5	125	41	20	28,5	17	MGM.1,5	M8X27	A4	
DKT 7031	DKT 7030	✓	62	2	20	20	19	125	41	20	28,5	17	MGM.2	M8X27	A4	
DKT 7040	DKT 7039	✓	62	3	20	20	18,5	125	41	20	28,5	18	MGM.3	M8X27	A4	
DKT 7047	DKT 7046	✓	62	4	20	20	18	125	41	20	28,5	18	MGM.4	M8X27	A4	
DKT 7051	x	✓	62	5	20	20	17,5	125	41	20	28,5	21	MGM.5	M8X27	A4	
DKT 7025	x	✓	62	1,5	25	25	24,25	125	41	25	35	18	MGM.1,5	M8X27	A4	
DKT 7033	DKT 7032	✓	62	2	25	25	24	150	45	25	35	18	MGM.2	M8X27	A4	
DKT 7042	DKT 7041	✓	62	3	25	25	23,5	150	45	25	35	21	MGM.3	M8X27	A4	
DKT 13037	x	✓	62	4	25	25	23	150	45	25	35	30	MGM.4	M8X27	A4	
DKT 7049	DKT 7048	✓	62	4	25	25	23	150	45	25	35	22	MGM.4	M8X27	A4	
DKT 7053	DKT 7052	✓	62	5	25	25	22,5	150	45	25	35	22	MGM.5	M8X27	A4	
DKT 7055	DKT 11461	✓	62	6	25	25	22	150	45	25	35	22	MGM.6	M8X27	A4	
DKT 7034	x	✓	62	2	32	32	31	170	45	32	42	21	MGM.2	M8X27	A4	
DKT 7043	x	✓	62	3	32	32	30,5	170	45	32	42	25	MGM.3	M8X27	A4	
DKT 7050	x	✓	62	4	32	32	30	170	45	32	42	25	MGM.4	M8X27	A4	
DKT 7054	x	✓	62	5	32	32	29,5	170	45	32	42	25	MGM.5	M8X27	A4	
DKT 7056	x	✓	62	6	32	32	29	170	45	32	42	25	MGM.6	M8X27	A4	
DKT 13036	x	✓	62	3	25	25	22	150	45	25	35	30	MGM.3	M8X27	A4	
DKT 7058	x	✓	62	3	25	25	23,5	150	45	25	35	40	MGM.3	M8X27	A4	
DKT 7057	x	✓	62	4	25	25	23	150	45	25	35	40	MGM.4	M8X27	A4	
DKT 7059	x	✓	62	5	25	25	22,5	150	45	25	35	40	MGM.5	M8X27	A4	

**DKT H**

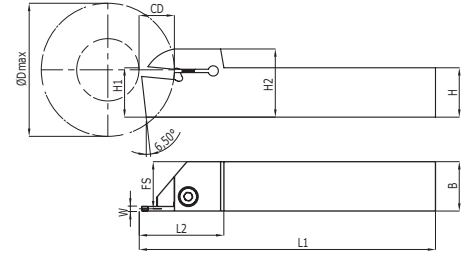

Kesici Uç Uyumluluğu Insert Suitability		Stok Stock	Takım Ölçüleri / Dimension (mm)										Uç Insert	Vida Screw	Anahtar Allen Key
DKT H			Dmax	W	H	B	FS	L1	L2	H1	H2	CD			
SİPARİŞ KODU - R Ordering Code - R	SİPARİŞ KODU - L Ordering Code - L														
DKT 6925	X	✓	62	3	16	16	14,5	125	46	16	24	22	S229-3	M8X27	A4
DKT 6927	DKT 6926	✓	62	3	20	20	18,5	125	46	20	28,5	22	S229-3	M8X27	A4
DKT 6932	DKT 6931	✓	62	4	20	20	18	125	46	20	28,5	22	S229-4	M8X27	A4
DKT 6937	DKT 6936	✓	62	5	20	20	17,5	125	46	20	28,5	22	S229-5	M8X27	A4
DKT 6929	DKT 6928	✓	62	3	25	25	23,5	150	46	25	35	23	S229-3	M8X27	A4
DKT 6934	DKT 6933	✓	62	4	25	25	23	150	46	25	35	23	S229-4	M8X27	A4
DKT 6939	DKT 6938	✓	62	5	25	25	22,5	150	46	25	35	23	S229-5	M8X27	A4
DKT 6941	X	✓	62	6	25	25	22	150	46	25	35	23	S229-6	M8X27	A4
DKT 6930	X	✓	62	3	32	32	30,5	170	46	32	42	24	S229-3	M8X27	A4
DKT 6935	X	✓	62	4	32	32	30	170	46	32	42	24	S229-4	M8X27	A4
DKT 6940	X	✓	62	5	32	32	27,5	170	46	32	42	24	S229-5	M8X27	A4

**DKT HK**

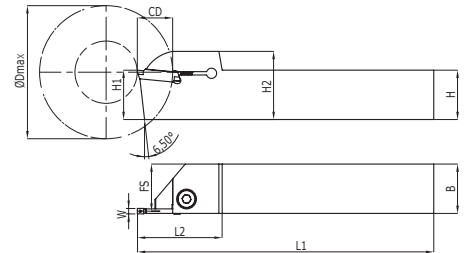
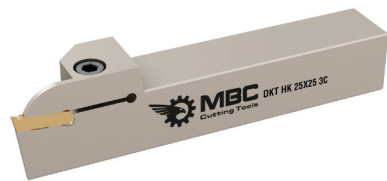

Kesici Uç Uyumluluğu Insert Suitability		Stok Stock	Takım Ölçüleri / Dimension (mm)										Uç Insert	Vida Screw	Anahtar Allen Key
S224 HRN			Dmax	W	H	B	FS	L1	L2	H1	H2	CD			
SİPARİŞ KODU - R Ordering Code - R	SİPARİŞ KODU - L Ordering Code - L														
DKT 6956	DKT 6955	✓	62	2	16	16	15	125	43	16	28	20	S224-2	M8X27	A4
DKT 6962	DKT 6961	✓	62	3	16	16	14,5	125	43	16	28	20	S224-3	M8X27	A4
DKT 6969	DKT 6968	✓	62	4	16	16	14	125	43	16	28	20	S224-4	M8X27	A4
DKT 6958	DKT 6957	✓	62	2	20	20	19	125	43	20	28	20	S224-2	M8X27	A4
DKT 6964	DKT 6963	✓	62	3	20	20	18,5	125	43	20	28	20	S224-3	M8X27	A4
DKT 6971	DKT 6970	✓	62	4	20	20	18	125	43	20	28	20	S224-4	M8X27	A4
DKT 6960	DKT 6959	✓	62	2	25	25	24	150	43	25	35	22	S224-2	M8X27	A4
DKT 6966	DKT 6965	✓	62	3	25	25	23,5	150	43	25	35	22	S224-3	M8X27	A4
DKT 6973	DKT 6972	✓	62	4	25	25	23	150	43	25	35	22	S224-4	M8X27	A4
DKT 6967	X	✓	62	3	32	32	30,5	170	46	32	42	22	S224-3	M8X27	A4
DKT 6974	X	✓	62	4	32	32	30	170	46	32	42	22	S224-4	M8X27	A4

#### DKT TT

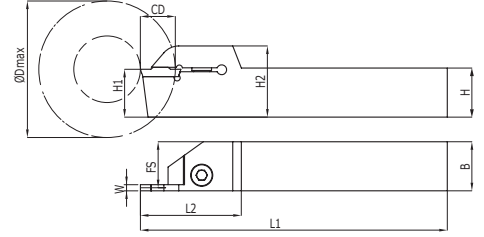

Kesici Uç Uyumluluğu Insert Suitability		Stok Stock	Takım Ölçüleri / Dimension (mm)										Uç Insert	Vida Screw	Anahtar Allen Key
DKT TT			Dmax	W	H	B	FS	L1	L2	H1	H2	CD			
SİPARİŞ KODU - R Ordering Code - R	SİPARİŞ KODU - L Ordering Code - L														
DKT 7140	X	✓	62	2	12	12	11	90	31	12	24	14	TD.. 2	M5X16	A4
DKT 7144	X	✓	62	3	12	12	10,5	90	31	12	24	14	TD.. 3	M5X16	A4
DKT 7141	X	✓	62	2	16	16	15	125	41	16	28,5	18	TD.. 2	M8X27	A4
DKT 7145	X	✓	62	3	16	16	14,5	125	41	18	28,5	18	TD.. 3	M8X27	A4
DKT 7149	X	✓	62	4	16	16	14	125	41	16	28,5	18	TD.. 4	M8X27	A4
DKT 7142	X	✓	62	2	20	20	19	125	41	20	28,5	18	TD.. 2	M8X27	A4
DKT 7146	X	✓	62	3	20	20	18,5	125	41	20	28,5	18	TD.. 3	M8X27	A4
DKT 7150	X	✓	62	4	20	20	18	125	41	20	28,5	18	TD.. 4	M8X27	A4
DKT 7143	X	✓	62	2	25	25	24	150	45	25	35	21	TD.. 2	M8X27	A4
DKT 7147	X	✓	62	3	25	25	23,5	150	45	25	35	21	TD.. 3	M8X27	A4
DKT 7151	X	✓	62	4	25	25	23	150	45	25	35	21	TD.. 4	M8X27	A4
DKT 7153	X	✓	62	5	25	25	22,5	150	45	25	35	21	TD.. 5	M8X27	A4
DKT 7148	X	✓	62	3	32	32	30,5	170	45	32	42	23	TD.. 3	M8X27	A4
DKT 7152	X	✓	62	4	32	32	30	170	45	32	42	23	TD.. 4	M8X27	A4

#### DKT ZCC

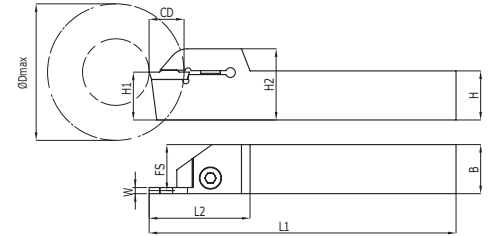

Kesici Uç Uyumluluğu Insert Suitability		Stok Stock	Takım Ölçüleri / Dimension (mm)										Uç Insert	Vida Screw	Anahtar Allen Key
DKT ZCC			Dmax	W	H	B	FS	L1	L2	H1	H2	CD			
SİPARİŞ KODU - R Ordering Code - R	SİPARİŞ KODU - L Ordering Code - L														
DKT 7196	DKT 7167	✓	62	2	16	16	15	125	41	16	24,5	17	ZT.D-2	M8X27	A4
DKT 7173	DKT 7172	✓	62	3	16	16	14,5	125	41	16	24,5	18	ZT.D-3	M8X27	A4
DKT 7179	DKT 7178	✓	62	4	16	16	14	125	41	16	24,5	18	ZT.D-4	M8X27	A4
DKT 7186	DKT 7185	✓	62	5	16	16	13,5	125	41	16	24,5	18	ZT.D-5	M8X27	A4
DKT 7170	DKT 7169	✓	62	2,5	20	20	18,75	125	41	20	28,5	17	ZT.D-2,5	M8X27	A4
DKT 7195	X	✓	62	2,5	20	20	18,75	125	41	20	28,5	22	ZT.D-2,5	M8X27	A4
DKT 7164	DKT 7163	✓	62	2	20	20	19	125	41	20	28,5	17	ZT.D-2	M8X27	A4
DKT 7175	DKT 7174	✓	62	3	20	20	18,5	125	41	20	28,5	18	ZT.D-3	M8X27	A4
DKT 7181	DKT 7180	✓	62	4	20	20	18	125	41	20	28,5	18	ZT.D-4	M8X27	A4
DKT 7187	DKT 7188	✓	62	5	20	20	17,5	125	41	20	28,5	21	ZT.D-5	M8X27	A4
DKT 7192	X	✓	62	6	20	20	17	125	41	20	28,5	21	ZT.D-6	M8X27	A4
DKT 7171	DKT 14180	✓	62	2,5	25	25	23,75	150	45	25	35	21	ZT.D-2,5	M8X27	A4
DKT 7166	DKT 7165	✓	62	2	25	25	24	150	45	25	35	21	ZT.D-2	M8X27	A4
DKT 7177	DKT 7176	✓	62	3	25	25	23,5	150	45	25	35	21	ZT.D-3	M8X27	A4
DKT 7183	DKT 7182	✓	62	4	25	25	23	150	45	25	35	21	ZT.D-4	M8X27	A4
DKT 7190	DKT 7189	✓	62	5	25	25	22,5	150	45	25	35	22	ZT.D-5	M8X27	A4
DKT 7193	X	✓	62	6	25	25	22	150	45	25	35	22	ZT.D-6	M8X27	A4
DKT 7184	X	✓	62	4	32	32	30	170	45	32	42	25	ZT.D-4	M8X27	A4
DKT 7191	X	✓	62	5	32	32	29,5	170	45	32	42	25	ZT.D-5	M8X27	A4
DKT 7194	X	✓	62	6	32	32	29	170	45	32	42	25	ZT.D-6	M8X27	A4

**DKT KYC**

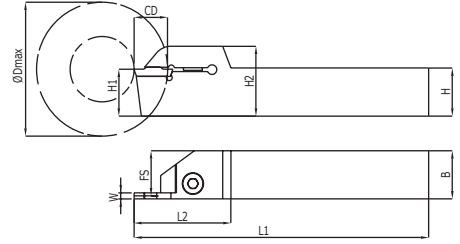

Kesici Uç Uyumluluđu Insert Suitability		Stok Stock	Takım Ölçüleri / Dimension (mm)										Uç İnsert	Vida Screw	Anahtar Allen Key
DKT KYC			Dmax	W	H	B	FS	L1	L2	H1	H2	CD			
SİPARİŐ KODU - R Ordering Code - R	SİPARİŐ KODU - L Ordering Code - L														
DKT 7063	X	✓	62	2	12	12	11	125	41	12	20,5	12	GDM-2	M5X16	A4
DKT 7078	X	✓	62	3	12	12	10,5	125	41	12	20,5	12	GDM-3	M5X16	A4
DKT 7068	DKT 7067	✓	62	2	16	16	15	125	41	16	24,5	17	GDM-2	M8X27	A4
DKT 7081	DKT 12222	✓	62	3	16	16	14,5	125	41	16	24,5	20	GDM-3	M8X27	A4
DKT 7070	DKT 7072	✓	62	2	20	20	19	125	41	20	28,5	17	GDM-2	M8X27	A4
DKT 7082	DKT 7083	✓	62	3	20	20	18,5	125	43	20	28,5	20	GDM-3	M8X27	A4
DKT 7088	X	✓	62	2	25	25	24	150	45	25	35	10	GDM-2	M8X27	A4
DKT 7074	DKT 7077	✓	62	2	25	25	24	150	45	25	35	21	GDM-2	M8X27	A4
DKT 7084	DKT 7085	✓	62	3	25	25	23,5	150	45	25	35	21	GDM-3	M8X27	A4
DKT 7089	X	✓	62	3	25	25	23,5	150	45	25	35	25	GDM-3	M8X27	A4
DKT 7090	X	✓	62	4	25	25	23	150	45	25	35	25	GDM-4	M8X27	A4

**DKT SND**

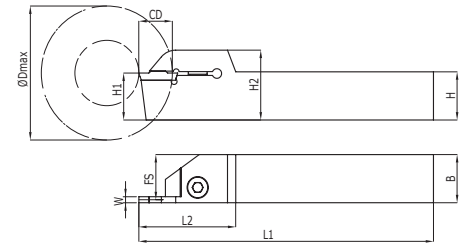

Kesici Uç Uyumluluđu Insert Suitability		Stok Stock	Takım Ölçüleri / Dimension (mm)										Uç İnsert	Vida Screw	Anahtar Allen Key
DKT SND			Dmax	W	H	B	FS	L1	L2	H1	H2	CD			
SİPARİŐ KODU - R Ordering Code - R	SİPARİŐ KODU - L Ordering Code - L														
DKT 7112	DKT 7113	✓	62	2	12	12	11	125	41	12	20,5	12	N123-2	M5X16	A4
DKT 7117	DKT 7115	✓	62	3	12	12	10,5	125	41	12	20,5	12	N123-3	M5X16	A4
DKT 7134	X	✓	62	1,5	16	16	14,5	125	41	16	24,5	18	N123-1,5	M8X27	A4
DKT 7136	DKT 12885	✓	62	2	16	16	15	125	41	16	24,5	18	N123-2	M8X27	A4
DKT 17157	X	✓	62	4	16	16	14	125	41	16	24,5	18	N123-4	M8X27	A4
DKT 7135	DKT 16876	✓	62	1,5	20	20	18,5	125	41	20	28,5	18	N123-1,5	M8X27	A4
DKT 7120	DKT 12884	✓	62	2	20	20	19	125	41	20	28,5	18	N123-2	M8X27	A4
DKT 7125	DKT 21320	✓	62	3	20	20	18,5	125	41	20	28,5	18	N123-3	M8X27	A4
DKT 7128	X	✓	62	4	20	20	18	125	41	20	28,5	20	N123-4	M8X27	A4
DKT 7130	X	✓	62	5	20	20	17,5	125	41	20	28,5	21	N123-5	M8X27	A4
DKT 7133	X	✓	62	1,5	25	25	24,25	150	45	25	35	18	N123-1,5	M8X27	A4
DKT 7122	DKT 7121	✓	62	2	25	25	24	150	45	25	35	21	N123-2	M8X27	A4
DKT 7127	DKT 7126	✓	62	3	25	25	23,5	150	45	25	35	21	N123-3	M8X27	A4
DKT 7129	X	✓	62	4	25	25	23	150	45	25	35	21	N123-4	M8X27	A4
DKT 7131	X	✓	62	5	25	25	22,5	150	45	25	35	23	N123-5	M8X27	A4
DKT 7132	X	✓	62	5	32	32	29,5	170	45	32	42	25	N123-5	M8X27	A4

### DKT KM

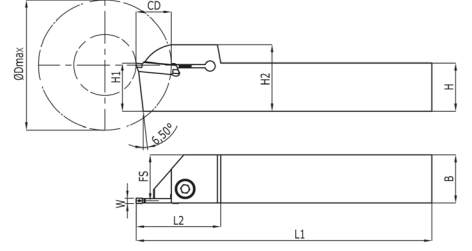

Kesici Uç Uyumluluğu Insert Suitability		Stok Stock	Takım Ölçüleri / Dimension (mm)										Uç Insert	Vida Screw	Anahtar Allen Key
DKT KM			Dmax	W	H	B	FS	L1	L2	H1	H2	CD			
SİPARİŞ KODU - R Ordering Code - R	SİPARİŞ KODU - L Ordering Code - L														
DKT 12977	X	✓	62	2	16	16	15	125	41	16	28	18	GMN-2	M8X27	A4
DKT 12955	X	✓	62	2	20	20	19	125	41	20	28,5	18	GMN-2	M8X27	A4
DKT 12956	X	✓	62	3	20	20	18,5	125	41	20	28,5	18	GMN-3	M8X27	A4
DKT 12957	X	✓	62	4	20	20	18	125	41	20	28,5	18	GMN-4	M8X27	A4
DKT 12958	X	✓	62	2	25	25	24	150	45	25	35	22	GMN-2	M8X27	A4
DKT 12959	X	✓	62	3	25	25	23,5	150	45	25	35	22	GMN-3	M8X27	A4
DKT 12960	X	✓	62	4	25	25	23	150	45	25	35	22	GMN-4	M8X27	A4
DKT 12963	X	✓	62	5	25	25	22,5	150	45	25	35	22	GMN-5	M8X27	A4
DKT 12964	X	✓	62	6	25	25	22	150	45	25	35	22	GMN-6	M8X27	A4

### DKT TNG

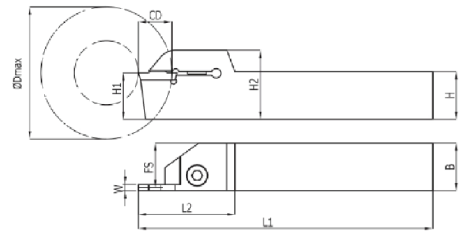

Kesici Uç Uyumluluğu Insert Suitability		Stok Stock	Takım Ölçüleri / Dimension (mm)										Uç Insert	Vida Screw	Anahtar Allen Key
DKT TNG			Dmax	W	H	B	FS	L1	L2	H1	H2	CD			
SİPARİŞ KODU - R Ordering Code - R	SİPARİŞ KODU - L Ordering Code - L														
DKT 7137	X	✓	62	2	16	16	15	125	41	16	28	17	GMN-2	M8X27	A4
DKT 7138	X	✓	62	2	20	20	19	125	41	20	28,5	18	GMN-2	M8X27	A4
DKT 7139	X	✓	62	2	25	25	24	150	45	25	35	22	GMN-2	M8X27	A4
DKT 17076	X	✓	62	3	16	16	14,5	125	41	16	28	17	GMN-3	M8X27	A4
DKT 17077	X	✓	62	3	20	20	18,5	125	41	20	28,5	18	GMN-3	M8X27	A4
DKT 17078	X	✓	62	3	25	25	23,5	150	45	25	35	22	GMN-3	M8X27	A4
DKT 17079	X	✓	62	4	16	16	14	125	41	16	24,5	17	GMN-4	M8X27	A4
DKT 17080	X	✓	62	4	20	20	18	125	41	20	28,5	18	GMN-4	M8X27	A4
DKT 17081	X	✓	62	4	25	25	23	150	45	25	35	22	GMN-4	M8X27	A4

## DKT VRG

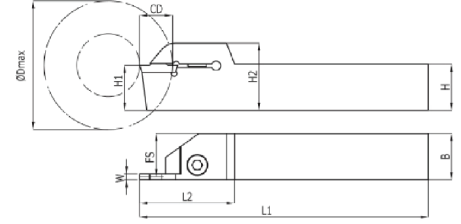

Kesici Uç Uyumluluğu Insert Suitability		Stok Stock	Takım Ölçüleri / Dimension (mm)										Uç Insert	Vida Screw	Anahtar Allen Key
DKT VRG			Dmax	W	H	B	FS	L1	L2	H1	H2	CD			
SİPARİŞ KODU - R Ordering Code - R	SİPARİŞ KODU - L Ordering Code - L														
DKT 16907	X	✓	62	2	16	16	15	125	41	16	28	16	VGD-2	M8X27	A4
DKT 16908	X	✓	62	3	16	16	14,5	125	41	16	28	16	VGD-3	M8X27	A4
DKT 7154	X	✓	62	2	20	20	19	125	41	20	28,5	20	VGD-2	M8X27	A4
DKT 7155	X	✓	62	3	20	20	18,5	125	41	20	28,5	20	VGD-3	M8X27	A4
DKT 16864	X	✓	62	4	20	20	18	125	41	20	28,5	18	VGD-4	M8X27	A4
DKT 7156	X	✓	62	2	25	25	24	150	45	25	35	22	VGD-2	M8X27	A4
DKT 7157	X	✓	62	3	25	25	23,5	150	45	25	35	22	VGD-3	M8X27	A4
DKT 7158	X	✓	62	4	25	25	23	150	45	25	35	22	VGD-4	M8X27	A4
DKT 7159	X	✓	62	3	32	32	30,5	170	45	32	42	24	VGD-3	M8X27	A4
DKT 7160	X	✓	62	4	32	32	30	170	45	32	42	24	VGD-4	M8X27	A4

## DKT H 360

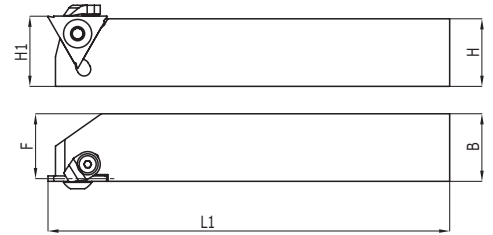

Kesici Uç Uyumluluğu Insert Suitability		Stok Stock	Takım Ölçüleri / Dimension (mm)								Uç Insert	Vida Screw	Pabuç Clamp	Vida Screw	Anahtar Torx Key	Anahtar Allen Key
DKT H 360			H1	H	B	F	L1	L2	AS	Y0						
SİPARİŞ KODU - R Ordering Code - R	SİPARİŞ KODU - L Ordering Code - L															
DKT 6946	X	✓	16	16	15,5	125	-	0	0	S312-1	M5X12	CK15	M4X10	T15	A3	
DKT 6947	X	✓	20	20	19,5	125	-	0	0	S312-1	M5X12	CK15	M4X10	T15	A3	
DKT 6948	X	✓	25	25	24,5	150	-	0	0	S312-1	M5X12	CK15	M4X10	T15	A3	
DKT 6949	X	✓	16	16	15	125	-	0	0	S312-2	M5X12	CK15	M4X10	T15	A3	
DKT 6950	X	✓	20	20	19	125	-	0	0	S312-2	M5X12	CK15	M4X10	T15	A3	
DKT 6951	X	✓	25	25	24	150	-	0	0	S312-2	M5X12	CK15	M4X10	T15	A3	
DKT 6952	X	✓	16	16	14,5	125	-	0	0	S312-3	M5X12	CK15	M4X10	T15	A3	
DKT 6953	X	✓	20	20	18,5	125	-	0	0	S312-3	M5X12	CK15	M4X10	T15	A3	
DKT 6954	X	✓	25	25	23,5	150	-	0	0	S312-3	M5X12	CK15	M4X10	T15	A3	
DKT 16853	X	✓	16	16	14	125	-	0	0	S312-4	M5X12	CK15	M4X10	T15	A3	
DKT 16854	X	✓	20	20	18	125	-	0	0	S312-4	M5X12	CK15	M4X10	T15	A3	
DKT 14320	X	✓	25	25	22,5	150	-	0	0	S312-5	M5X12	CK15	M4X10	T15	A3	

### AKT - MGMN

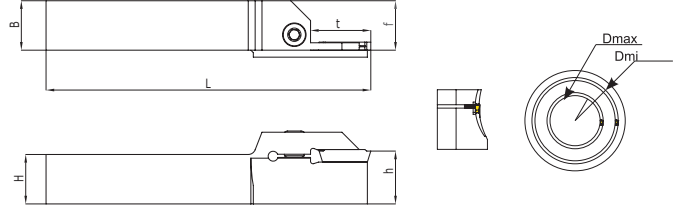

Kesici Uç Uyumluluğu Insert Suitability		Stok Stock	Takım Ölçüleri / Dimension (mm)								Uç Insert	Vida Screw	Anahtar Allen Key
AKT - MGMN			Dmin	Dmax	H	B	f	L1	h	t max			
SİPARİŞ KODU - R Ordering Code - R	SİPARİŞ KODU - L Ordering Code - L												
AKT 21287	AKT 21340	✓	25	35	25	25	26,7	150	25	17	MGM.3	8X27	A4
AKT 6835	AKT 21322	✓	30	40	25	25	26,7	150	25	17	MGM.3	8X27	A4
AKT 6836	AKT 21323	✓	35	50	25	25	26,7	150	25	17	MGM.3	8X27	A4
AKT 6837	AKT 21324	✓	45	70	25	25	26,7	150	25	17	MGM.3	8X27	A4
AKT 6838	AKT 21325	✓	65	105	25	25	26,7	150	25	17	MGM.3	8X27	A4
AKT 6839	AKT 21326	✓	100	150	25	25	26,7	150	25	17	MGM.3	8X27	A4
AKT 16874	AKT 21327	✓	150	200	25	25	26,8	150	25	17	MGM.3	8X27	A4
AKT 21288	AKT 21328	✓	25	35	25	25	26,8	150	25	22	MGM.4	8X27	A4
AKT 6840	AKT 21329	✓	30	40	25	25	26,8	150	25	22	MGM.4	8X27	A4
AKT 6841	AKT 21330	✓	35	50	25	25	26,8	150	25	22	MGM.4	8X27	A4
AKT 6842	AKT 21331	✓	45	70	25	25	26,8	150	25	22	MGM.4	8X27	A4
AKT 6843	AKT 21332	✓	65	105	25	25	26,8	150	25	22	MGM.4	8X27	A4
AKT 6844	AKT 21333	✓	100	150	25	25	26,8	150	25	22	MGM.4	8X27	A4
AKT 16875	AKT 21334	✓	150	200	25	25	26,8	150	25	22	MGM.4	8X27	A4
AKT 6845	AKT 21335	✓	75	110	25	25	27	150	25	25	MGM.5	8X27	A4
AKT 6846	AKT 21336	✓	105	150	25	25	27	150	25	25	MGM.5	8X27	A4
AKT 6847	AKT 21337	✓	145	200	25	25	27	150	25	25	MGM.5	8X27	A4
AKT 21285	AKT 21338	✓	150	300	25	25	27	150	25	25	MGM.5	8X27	A4
AKT 21286	AKT 21339	✓	300	500	25	25	27	150	25	25	MGM.5	8X27	A4

### AKT - ZCC

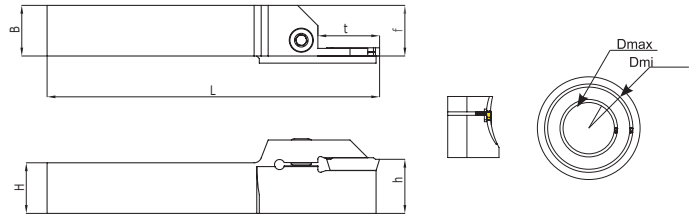

Kesici Uç Uyumluluğu Insert Suitability		Stok Stock	Takım Ölçüleri / Dimension (mm)								Uç Insert	Vida Screw	Anahtar Allen Key
AKT - ZCC			Dmin	Dmax	H	B	f	L1	h	t max			
SİPARİŞ KODU - R Ordering Code - R	SİPARİŞ KODU - L Ordering Code - L												
AKT 12284	x	✓	25	35	25	25	27	150	25	17	ZT.D-3	8X27	A4
AKT 12285	x	✓	35	45	25	25	27	150	25	17	ZT.D-3	8X27	A4
AKT 12286	x	✓	39	55	25	25	27	150	25	17	ZT.D-3	8X27	A4
AKT 12287	x	✓	49	80	25	25	27	150	25	17	ZT.D-3	8X27	A4
AKT 12288	x	✓	70	110	25	25	27	150	25	17	ZT.D-3	8X27	A4
x	AKT 12555	✓	70	110	25	25	27	150	25	10	ZT.D-3	8X27	A4
AKT 12289	x	✓	100	150	25	25	27	150	25	17	ZT.D-3	8X27	A4
AKT 12290	x	✓	40	60	25	25	27	150	25	22	ZT.D-4	8X27	A4
AKT 12291	x	✓	52	80	25	25	27	150	25	22	ZT.D-4	8X27	A4
AKT 12292	x	✓	72	110	25	25	27	150	25	22	ZT.D-4	8X27	A4
AKT 12293	x	✓	100	150	25	25	27	150	25	22	ZT.D-4	8X27	A4
AKT 12294	x	✓	140	200	25	25	27	150	25	22	ZT.D-4	8X27	A4
AKT 12295	x	✓	55	95	25	25	27	150	25	25	ZT.D-5	8X27	A4
AKT 12296	x	✓	85	140	25	25	27	150	25	25	ZT.D-5	8X27	A4
AKT 12297	x	✓	130	200	25	25	27	150	25	25	ZT.D-5	8X27	A4
x	AKT 12442	✓	120	240	25	25	27	150	25	38	ZT.D-6	8X27	A4

**LKT - MGMN**

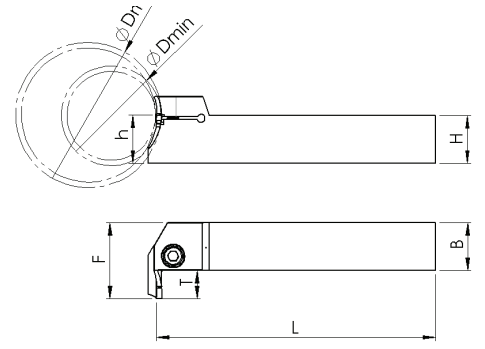

Kesici Uç Uyumluluđu Insert Suitability		Stok Stock	Takım Ölçüleri / Dimension (mm)								Uç Insert	Vida Screw	Anahtar Allen Key
LKT - MGMN			Dmin	Dmax	H	B	f	L1	h	t max			
SİPARİŐ KODU - R Ordering Code - R	SİPARİŐ KODU - L Ordering Code - L												
LKT 12700	X	✓	30	40	25	25	39	150	25	14	MGM.3	8X27	A4
LKT 12701	X	✓	35	50	25	25	39	150	25	14	MGM.3	8X27	A4
LKT 12702	X	✓	45	70	25	25	39	150	25	14	MGM.3	8X27	A4
LKT 12703	X	✓	65	105	25	25	39	150	25	14	MGM.3	8X27	A4
LKT 12704	X	✓	100	150	25	25	39	150	25	14	MGM.3	8X27	A4
LKT 12705	X	✓	150	200	25	25	39	150	25	14	MGM.3	8X27	A4
LKT 12706	X	✓	200	300	25	25	39	150	25	14	MGM.3	8X27	A4
LKT 12707	X	✓	300	500	25	25	39	150	25	14	MGM.3	8X27	A4
LKT 12708	X	✓	35	50	25	25	42	150	25	17	MGM.4	8X27	A4
LKT 12709	X	✓	45	70	25	25	42	150	25	17	MGM.4	8X27	A4
LKT 12710	X	✓	65	105	25	25	42	150	25	17	MGM.4	8X27	A4
LKT 12711	X	✓	100	150	25	25	42	150	25	17	MGM.4	8X27	A4
LKT 12712	X	✓	150	200	25	25	42	150	25	17	MGM.4	8X27	A4

**DKT I KAYAR OTOMAT**

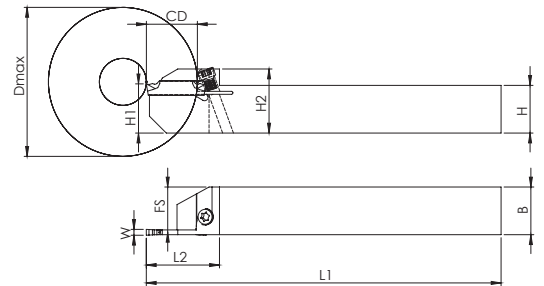

Kesici Uç Uyumluluđu Insert Suitability		Stok Stock	Takım Ölçüleri / Dimension (mm)										Uç Insert	Vida Screw	Anahtar Torx Key
DKT I KAYAR OTOMAT			Dmax	W	H	B	FS	L1	L2	H1	H2	CD			
SİPARİŐ KODU - R Ordering Code - R	SİPARİŐ KODU - L Ordering Code - L														
DKT 16861	X	✓	50	2	10	10	9	125	30	12	21	10	DGN-2	M4X11	T15
DKT 6988	DKT 6983	✓	50	2	12	12	11	125	30	12	21	12	DGN-2	M4X11	T15
DKT 7000	DKT 7002	✓	50	3	12	12	10,5	125	30	12	21	12	DGN-3	M4X11	T15
DKT 11368	DKT 11369	✓	50	2	16	16	15	125	30	16	21	15	DGN-2	M4X11	T15
DKT 11370	DKT 11371	✓	50	3	16	16	14,5	125	30	16	21	15	DGN-3	M4X11	T15

**DKT K KAYAR OTOMAT**

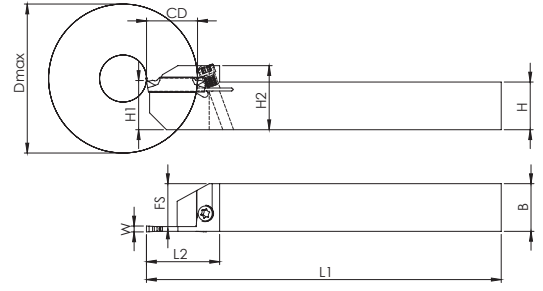

Kesici Uç Uyumluluğu Insert Suitability		Stok Stock	Takım Ölçüleri / Dimension (mm)										Uç Insert	Vida Screw	Anahtar Torx Key
SİPARİŞ KODU - R Ordering Code - R	SİPARİŞ KODU - L Ordering Code - L		Dmax	W	H	B	FS	L1	L2	H1	H2	CD			
DKT 14321	DKT 17067	✓	50	1,5	12	12	11,25	125	30	12	21	12	MGM.1,5	M4X11	T15
DKT 17063	DKT 17064	✓	50	2	12	12	11	125	30	12	21	12	MGM.2	M4X11	T15
DKT 17065	DKT 17066	✓	50	3	12	12	10,5	125	30	12	21	12	MGM.3	M4X11	T15
DKT 17061	DKT 17062	✓	50	1,5	16	16	15,25	125	30	16	21	15	MGM.1,5	M4X11	T15
DKT 17057	DKT 17058	✓	50	2	16	16	15	125	30	16	21	15	MGM.2	M4X11	T15
DKT 17059	DKT 17060	✓	50	3	16	16	14,5	125	30	16	21	15	MGM.3	M4X11	T15

**DKT SND KAYAR OTOMAT**

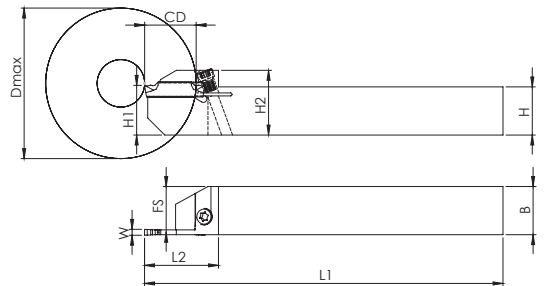

Kesici Uç Uyumluluğu Insert Suitability		Stok Stock	Takım Ölçüleri / Dimension (mm)										Uç Insert	Vida Screw	Anahtar Torx Key
SİPARİŞ KODU - R Ordering Code - R	SİPARİŞ KODU - L Ordering Code - L		Dmax	W	H	B	FS	L1	L2	H1	H2	CD			
DKT 21238	DKT 7109	✓	50	1,5	12	12	11,25	125	30	12	21	12	N123-1,5	M4X11	T15
DKT 7119	DKT 7118	✓	50	2	12	12	11	125	30	12	21	12	N123-2	M4X11	T15
DKT 7124	DKT 7123	✓	50	3	12	12	10,5	125	30	12	21	12	N123-3	M4X11	T15
DKT 7116	DKT 7114	✓	50	1,5	16	16	15,25	125	30	16	21	15	N123-1,5	M4X11	T15

## DKT KYC KAYAR OTOMAT

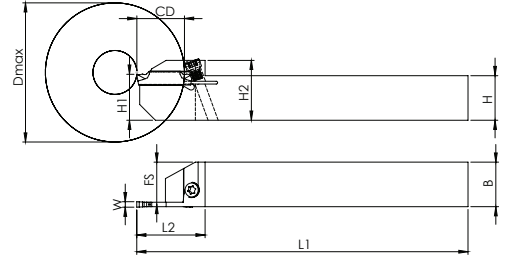

Kesici Uç Uyumluluđu Insert Suitability		Stok Stock	Takım Ölçüleri / Dimension (mm)									Uç Insert	Vida Screw	Anahtar Torx Key	
SİPARİŐ KODU - R Ordering Code - R	SİPARİŐ KODU - L Ordering Code - L		Dmax	W	H	B	FS	L1	L2	H1	H2	CD			
DKT 17093	DKT 7065	✓	50	2	10	10	9	125	30	10	21	12	GDM-2	M4X11	T15
DKT 7066	DKT 7069	✓	50	2	12	12	11	125	30	12	21	12	GDM-2	M4X11	T15
DKT 7075	DKT 7076	✓	50	3	12	12	10,5	125	30	12	21	12	GDM-3	M4X11	T15
DKT 7071	DKT 7073	✓	50	2	16	16	15	125	30	16	21	15	GDM-2	M4X11	T15
DKT 7079	DKT 7080	✓	50	3	16	16	14,5	125	30	16	21	15	GDM-3	M4X11	T15

## DKT ZCC KAYAR OTOMAT

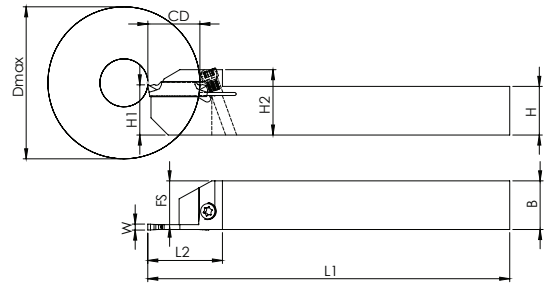



Kesici Uç Uyumluluđu Insert Suitability		Stok Stock	Takım Ölçüleri / Dimension (mm)									Uç Insert	Vida Screw	Anahtar Torx Key	
SİPARİŐ KODU - R Ordering Code - R	SİPARİŐ KODU - L Ordering Code - L		Dmax	W	H	B	FS	L1	L2	H1	H2	CD			
DKT 12370	DKT 12371	✓	50	3	12	12	10,5	125	30	12	21	12	ZT.D-3	M4X11	T15
DKT 12073	DKT 12074	✓	50	2	12	12	11	125	30	12	21	12	ZT.D-2	M4X11	T15
DKT 12061	DKT 12060	✓	50	2	16	16	15	125	30	16	21	15	ZT.D-2	M4X11	T15
DKT 11516	DKT 11517	✓	50	3	16	16	14,5	125	30	16	21	15	ZT.D-3	M4X11	T15

### LTT

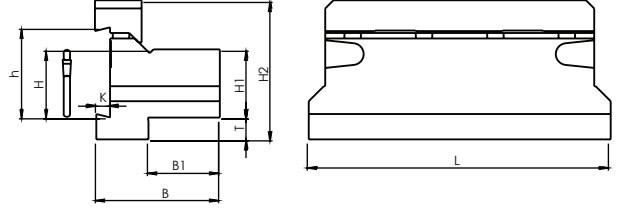
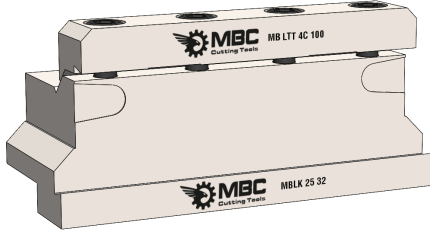
NEW





Kesici Uç Uyumluluğu Insert Suitability	Stok Stock	Takım Ölçüleri / Dimension (mm)										Vida Screw	Anahtar Allen Key
LTT		h	H	H1	H2	T	B	B1	K	L1			
SIPARIŞ KODU Ordering Code													
MBLT 14346	✓	26	21,4	20	43	9	38	21	4,1	86	M6X16	A5	
MBLT 14347	✓	32	25	20	50	13	38	19	5,3	100	M6X16	A5	
MBLT 14348	✓	26	21,4	25	45	5	42	25	4,1	110	M6X16	A5	
MBLT 14349	✓	32	25	25	50	7,8	42	23	5,3	110	M6X16	A5	
MBLT 14350	✓	32	25	32	54	5	48	29	5,3	110	M6X16	A5	

### MBL I DGN

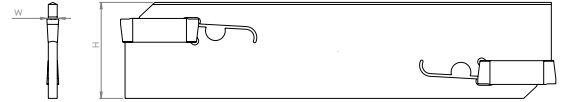
NEW





Kesici Uç Uyumluluğu Insert Suitability	Stok Stock	Takım Ölçüleri / Dimension (mm)							Uç Insert	Anahtar Blade Key
MBL I DGN		W	H	h	A	L1	CD			
SIPARIŞ KODU Ordering Code										
DKTL 16882	✓	2	26	21,4	1,60	110	36	DGN-2	L5	
DKTL 16538	✓	3	26	21,4	2,30	110	36	DGN-3	L5	
DKTL 16881	✓	4	26	21,4	3,30	110	36	DGN-4	L5	
DKTL 16880	✓	2	32	25	1,60	150	36	DGN-2	L5	
DKTL 16526	✓	3	32	25	2,30	150	36	DGN-3	L5	
DKTL 16888	✓	4	32	25	3,30	150	36	DGN-4	L5	

## MBL K MGMN

NEW





Kesici Uç Uyumluluğu Insert Suitability	Stok Stock	Takım Ölçüleri / Dimension (mm)						Uç Insert	Anahtar Blade Key
		W	H	h	A	L1	CD		
MBL K MGMN									
SİPARİŞ KODU Ordering Code									
DKTL 16829	✓	2	26	21,4	1,60	110	36	MGM.2	L5
DKTL 16828	✓	3	26	21,4	2,30	110	36	MGM.3	L5
DKTL 16830	✓	4	26	21,4	3,30	110	36	MGM.4	L5
DKTL 16833	✓	2	32	25	1,60	150	36	MGM.2	L5
DKTL 16834	✓	3	32	25	2,30	150	36	MGM.3	L5
DKTL 16835	✓	4	32	25	3,30	150	36	MGM.4	L5

## MBL ZCC ZT.D

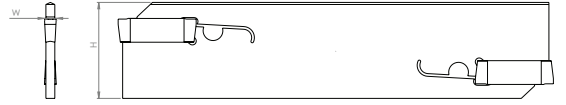
NEW



Kesici Uç Uyumluluğu Insert Suitability	Stok Stock	Takım Ölçüleri / Dimension (mm)						Uç Insert	Anahtar Blade Key
		W	H	h	A	L1	CD		
MBL ZCC ZT.D									
SİPARİŞ KODU Ordering Code									
DKTL 21274	✓	2	26	21,4	1,6	110	36	ZT.D-2	L5
DKTL 16868	✓	3	26	21,4	2,3	110	36	ZT.D-3	L5
DKTL 21275	✓	4	26	21,4	3,3	110	36	ZT.D-4	L5
DKTL 21202	✓	2	32	25	1,6	150	36	ZT.D-2	L5
DKTL 16869	✓	3	32	25	2,3	150	36	ZT.D-3	L5
DKTL 21237	✓	4	32	25	3,3	150	36	ZT.D-4	L5



# İÇ KANAL KATERLERİ

INTERNAL GROOVING TOOLHOLDERS

### IKT K

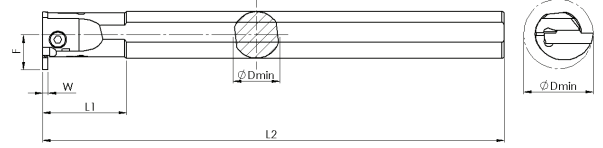

Kesici Uç Uyumluluğu Insert Suitability		Stok Stock	Takım Ölçüleri / Dimension (mm)								Uç Insert	Vida Screw	Anahtar Allen Key
IKT K			D	D min	F	L1	L2	W	CD				
SİPARİŞ KODU - R Ordering Code - R	SİPARİŞ KODU - L Ordering Code - L												
IKT 7305	IKT 17049	✓	16	20	12	180	25	2	4	MGM.2	M4X10	A3	
IKT 7306	IKT 17050	✓	20	25	14	200	30	2	4	MGM.2	M4X12	A3	
IKT 7309	IKT 17051	✓	20	25	14,5	200	30	3	4,5	MGM.3	M4X12	A3	
IKT 7312	IKT 17052	✓	20	25	14,5	200	30	4	4,5	MGM.4	M4X12	A3	
IKT 7307	IKT 17053	✓	25	31	18	250	35	2	5,5	MGM.2	M6X16	A5	
IKT 7310	IKT 17054	✓	25	32	16,5	250	35	3	6	MGM.3	M6X16	A5	
IKT 7313	IKT 17055	✓	25	32	18,5	250	30	4	6	MGM.4	M6X16	A5	
IKT 7319	X	✓	25	32	18,5	250	30	5	6	MGM.5	M6X16	A5	
IKT 7308	X	✓	32	39	22	250	30	2	6	MGM.2	M8X27	A4	
IKT 7311	X	✓	32	42	25	250	35	3	9	MGM.3	M8X27	A4	
IKT 7314	X	✓	32	42	25	250	35	4	9	MGM.4	M8X27	A4	
IKT 7318	X	✓	32	42	25	250	35	5	9	MGM.5	M8X27	A4	
IKT 7315	X	✓	40	52	30	350	60	3	10	MGM.3	M8X27	A4	
IKT 7316	X	✓	40	52	30	350	60	4	10	MGM.4	M8X27	A4	
IKT 7317	X	✓	40	52	30	350	60	5	10	MGM.5	M8X27	A4	

### IKT I

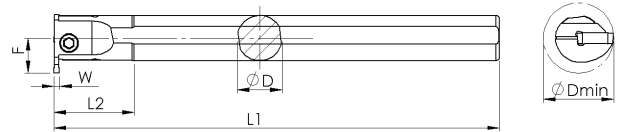

Kesici Uç Uyumluluğu Insert Suitability		Stok Stock	Takım Ölçüleri / Dimension (mm)								Uç Insert	Vida Screw	Anahtar Allen Key
IKT I			D	D min	F	L1	L2	W	CD				
SİPARİŞ KODU - R Ordering Code - R	SİPARİŞ KODU - L Ordering Code - L												
IKT 7281	X	✓	20	25	14	200	30	2	4,5	DGN-2	M4X12	A3	
IKT 7284	X	✓	20	25	14	200	30	3	4,5	DGN-3	M4X12	A3	
IKT 7287	X	✓	20	25	14	200	30	4	4,5	DGN-4	M4X12	A3	
IKT 7282	X	✓	25	32	18,5	250	40	2	6	DGN-2	M6X16	A5	
IKT 7285	X	✓	25	32	18,5	250	40	3	6	DGN-3	M6X16	A5	
IKT 7288	X	✓	25	32	18,5	250	40	4	6	DGN-4	M6X16	A5	
IKT 7283	X	✓	32	41	24,5	250	45	2	8,5	DGN-2	M8X27	A4	
IKT 7286	X	✓	32	41	24,5	250	45	3	8,5	DGN-3	M8X27	A4	
IKT 7289	X	✓	32	41	24,5	350	45	4	8,5	DGN-4	M8X27	A4	

### IKT HK

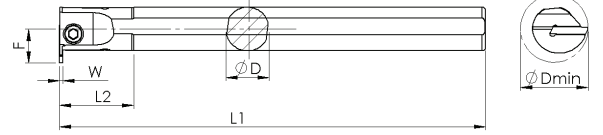

Kesici Uç Uyumluluğu Insert Suitability		Stok Stock	Takım Ölçüleri / Dimension (mm)							Uç İnsert	Vida Screw	Anahtar Allen Key
IKT HK	SIPARIŞ KODU - R Ordering Code - R		SIPARIŞ KODU - L Ordering Code - L	D	D min	F	L1	L2	W	CD		
X	X	✓	20	25	14	200	30	2	4,5	S224-2	M4X12	A3
X	X	✓	20	25	14	200	30	3	4,5	S224-3	M4X12	A3
X	X	✓	20	25	14	200	30	4	4,5	S224-4	M4X12	A3
X	X	✓	25	32	19	250	40	2	6,5	S224-2	M6X16	A5
X	X	✓	25	32	19	250	40	3	6,5	S224-3	M6X16	A5
X	X	✓	25	32	19	250	40	4	6,5	S224-4	M6X16	A5
X	X	✓	32	40	23	250	45	2	7	S224-2	M8X27	A4
X	X	✓	32	40	23	250	45	3	7	S224-3	M8X27	A4
X	X	✓	32	40	23	350	45	4	7	S224-4	M8X27	A4

### IKT H

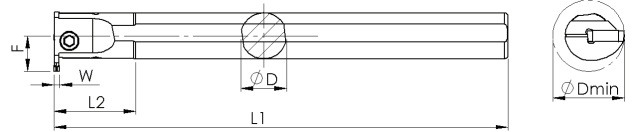

Kesici Uç Uyumluluğu Insert Suitability		Stok Stock	Takım Ölçüleri / Dimension (mm)							Uç İnsert	Vida Screw	Anahtar Allen Key
IKT H	SIPARIŞ KODU - R Ordering Code - R		SIPARIŞ KODU - L Ordering Code - L	D	D min	F	L1	L2	W	CD		
X	X	✓	25	34	20,5	250	40	3	8	S229-3	M6X16	A5
X	X	✓	25	34	20,5	250	40	4	8	S229-4	M6X16	A5
X	X	✓	25	34	20,5	250	40	5	8	S229-5	M6X16	A5
X	X	✓	32	43	26	250	45	3	10	S229-3	M8X27	A4
X	X	✓	32	43	26	250	45	4	10	S229-4	M8X27	A4
X	X	✓	32	43	26	250	45	5	10	S229-5	M8X27	A4
X	X	✓	40	52	30	350	60	3	10	S229-3	M8X27	A4
X	X	✓	40	52	30	350	60	4	10	S229-4	M8X27	A4
X	X	✓	40	52	30	350	60	5	10	S229-5	M8X27	A4

## IKT ZCC

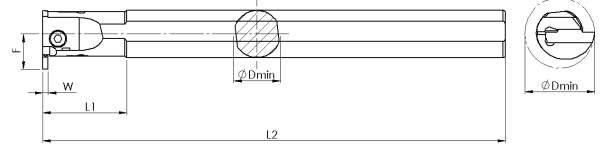

Kesici Uç Uyumluluğu Insert Suitability		Stok Stock	Takım Ölçüleri / Dimension (mm)							Uç Insert	Vida Screw	Anahtar Allen Key
SİPARİŞ KODU - R Ordering Code - R	SİPARİŞ KODU - L Ordering Code - L		D	D min	F	L1	L2	W	CD			
IKT 7358	X	✓	16	20	12	180	2	4	4	ZT.D-2	M4X10	A3
IKT 7359	X	✓	20	25	14,5	200	2	4	4,5	ZT.D-2	M4X12	A3
IKT 7350	X	✓	20	25	14,5	200	3	1,5	4,5	ZT.D-3	M4X12	A3
IKT 7357	X	✓	25	32	18,5	250	2	4	6	ZT.D-2	M6X16	A5
IKT 7351	X	✓	25	32	18,5	250	3	2	6	ZT.D-3	M6X16	A5
IKT 7353	X	✓	25	32	18,5	250	4	2	6	ZT.D-4	M6X16	A5
IKT 7352	X	✓	32	42	25	250	3	2	8	ZT.D-3	M8X27	A4
IKT 7354	X	✓	32	42	25	250	4	3	9	ZT.D-4	M8X27	A4
IKT 7355	X	✓	32	42	25	250	5	3	9	ZT.D-5	M8X27	A4
IKT 12861	X	✓	40	52	25	350	4	3	10	ZT.D-4	M8X27	A4
IKT 7356	X	✓	40	52	30	350	5	3	10	ZT.D-5	M8X27	A4

## IKT SND

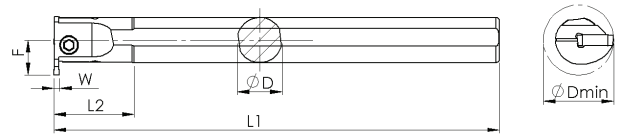

Kesici Uç Uyumluluğu Insert Suitability		Stok Stock	Takım Ölçüleri / Dimension (mm)							Uç Insert	Vida Screw	Anahtar Allen Key
SİPARİŞ KODU - R Ordering Code - R	SİPARİŞ KODU - L Ordering Code - L		D	D min	F	L1	L2	W	CD			
IKT 16870	X	✓	16	20	12	180	25	2	4	N123-2	M4X12	A3
IKT 16855	X	✓	16	20	12	180	25	3	4	N123-3	M4X12	A3
IKT 7338	X	✓	20	25	14	200	30	2	4,5	N123-2	M4X12	A3
IKT 7332	X	✓	20	25	14,5	200	30	3	4,5	N123-3	M4X12	A3
IKT 7339	X	✓	25	32	18	250	35	2	6	N123-2	M6X16	A5
IKT 7333	X	✓	25	32	18,5	250	35	3	6	N123-3	M6X16	A5
IKT 7335	X	✓	25	32	18,5	250	30	4	6	N123-4	M6X16	A5
IKT 7334	X	✓	32	42	25	250	35	3	9	N123-3	M8X27	A4
IKT 7336	X	✓	32	42	25	250	35	4	9	N123-4	M8X27	A4

### IKT I GRP

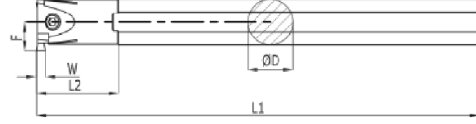

Kesici Uç Uyumluluğu Insert Suitability		Stok Stock	Takım Ölçüleri / Dimension (mm)							Uç Insert	Vida Screw	Anahtar Allen Key
IKT I GRP			D	D min	F	L1	L2	W	CD			
SİPARİŞ KODU - R Ordering Code - R	SİPARİŞ KODU - L Ordering Code - L											
IKT 7290	X	✓	16	20	12	180	25	3	4	TGM-3	M4X10	A3
IKT 7291	X	✓	20	25	14	200	30	3	4	TGM-3	M4X12	A3
IKT 7292	X	✓	25	31	18	250	35	3	5,5	TGM-3	M6X16	A5

### IKT KYC

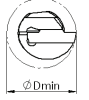
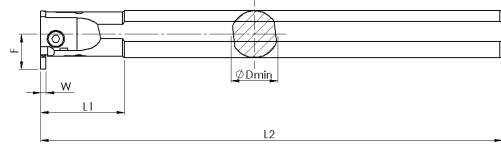

Kesici Uç Uyumluluğu Insert Suitability		Stok Stock	Takım Ölçüleri / Dimension (mm)							Uç Insert	Vida Screw	Anahtar Allen Key
IKT KYC			D	D min	F	L1	L2	W	CD			
SİPARİŞ KODU - R Ordering Code - R	SİPARİŞ KODU - L Ordering Code - L											
IKT 7328	X	✓	16	18	9,5	180	25	2	4,5	GDM-2	M4X12	A3
IKT 7329	X	✓	16	18	9,5	180	25	3	4,5	GDM-3	M4X12	A3
IKT 7320	X	✓	20	25	14	200	30	2	4	GDM-2	M4X12	A3
IKT 7321	X	✓	20	25	14	200	30	3	4	GDM-3	M4X12	A3
IKT 12634	X	✓	20	25	14	200	30	4	5,5	GDM-4	M4X12	A3
IKT 12614	X	✓	20	25	14	200	30	2	4	GDM-2	M4X12	A3
IKT 12615	X	✓	20	25	14	200	30	3	4	GDM-3	M4X12	A3
IKT 12076	X	✓	25	31	18	250	35	2	5	GDM-2	M6X16	A5
IKT 7322	X	✓	25	31	18	250	35	3	5,5	GDM-3	M6X16	A5
IKT 7326	X	✓	25	31	24,5	250	35	4	11	GDM-4	M6X16	A5
IKT 12698	X	✓	25	31	18	250	35	4	6	GDM-4	M6X16	A5
IKT 7323	X	✓	32	42	25	250	35	3	9	GDM-3	M8X27	A4
IKT 7324	X	✓	32	42	25	250	35	4	9	GDM-4	M8X27	A4
IKT 7327	X	✓	32	42	28	350	60	4	11	GDM-4	M8X27	A4
IKT 7325	X	✓	40	52	30	350	60	4	10	GDM-4	M8X27	A4

**IKT VRG**

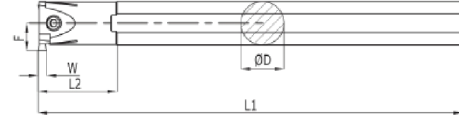

Kesici Uç Uyumluluğu Insert Suitability		Stok Stock	Takım Ölçüleri / Dimension (mm)								Uç İnsert	Vida Screw	Anahtar Allen Key
SİPARİŞ KODU - R Ordering Code - R	SİPARİŞ KODU - L Ordering Code - L		D	D min	F	L1	L2	W	CD				
IKT 7340	X	✓	20	25	14	200	30	2	4	VGD-2	M4X12	A3	
IKT 7341	X	✓	20	25	14	200	30	3	4	VGD-3	M4X12	A3	
IKT 7342	X	✓	25	31	18	250	35	2	5,5	VGD-2	M6X16	A5	
IKT 7343	X	✓	25	31	18	250	35	3	5,5	VGD-3	M6X16	A5	
IKT 7344	X	✓	25	31	18	250	35	4	5,5	VGD-4	M6X16	A5	
IKT 7345	X	✓	32	42	25	250	35	2	9	VGD-2	M8X27	A4	
IKT 7346	X	✓	32	42	25	250	35	3	9	VGD-3	M8X27	A4	
IKT 7347	X	✓	32	42	25	250	35	4	9	VGD-4	M8X27	A4	



## S-SİSTEM DIŞ ÇAP TORNALAMA KATERLER

### S-SYSTEM EXTERNAL TURNING TOOLHOLDERS

**SVJBR ISO**



93°

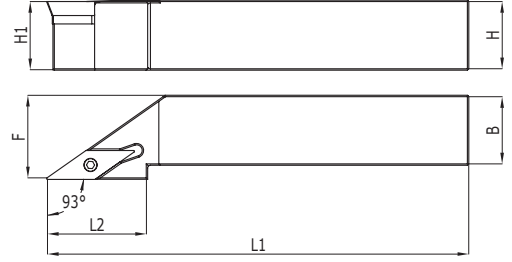

Kesici Uç Uyumluluğu Insert Suitability		Stok Stock	Takım Ölçüleri / Dimension (mm)								Uç Insert	Aitlik Shim	Vida Screw	Vida Screw	Anahtar Torx Key
SVJBR ISO			H1	H	B	F	L1	L2	λS	Y0					
SIPARIŞ KODU - R Ordering Code - R	SIPARIŞ KODU - L Ordering Code - L														
D 9496	X	✓	12	12	20	125	20	0	0	VBM. 1103	-	-	M2,5X7	T08	
D 9488	D 9481	✓	16	16	20	100	25	0	0	VBM. 1103	-	-	M2,5X7	T08	
D 9489	D 9482	✓	16	16	20	100	25	0	0	VBM. 1604	VBMT 16	M5X0,5X3,5	M3,5X14	T15	
D 9490	D 9483	✓	20	20	25	125	35	0	0	VBM. 1103	-	-	M2,5X7	T08	
D 9491	D 9484	✓	20	20	25	125	35	0	0	VBM. 1604	VBMT 16	M5X0,5X3,5	M3,5X14	T15	
D 9494	X	✓	25	25	32	150	40	0	0	VBM. 1103	-	-	M2,5X7	T08	
D 9492	D 9485	✓	25	25	32	150	40	0	0	VBM. 1604	VBMT 16	M5X0,5X3,5	M3,5X14	T15	
D 9493	D 9486	✓	32	32	40	170	40	0	0	VBM. 1604	VBMT 16	M5X0,5X3,5	M3,5X14	T15	

**SVVBN ISO**

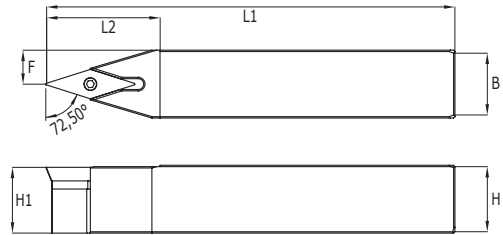

Kesici Uç Uyumluluğu Insert Suitability		Stok Stock	Takım Ölçüleri / Dimension (mm)								Uç Insert	Aitlik Shim	Vida Screw	Vida Screw	Anahtar Torx Key
SVVBN ISO			H1	H	B	F	L1	L2	λS	Y0					
SIPARIŞ KODU Ordering Code															
D 9534		✓	12	12	6	100	20	0	0	VBM. 1103	-	-	M2,5X7	T08	
D 9535		✓	16	16	8	100	25	0	0	VBM. 1103	-	-	M2,5X7	T08	
D 9537		✓	16	16	8	100	25	0	0	VBM. 1604	VBMT 16	M5X0,5X3,5	M3,5X14	T15	
D 9536		✓	20	20	10	125	35	0	0	VBM. 1103	-	-	M2,5X7	T08	
D 9538		✓	20	20	10	125	35	0	0	VBM. 1604	VBMT 16	M5X0,5X3,5	M3,5X14	T15	
D 9539		✓	25	25	12,5	150	40	0	0	VBM. 1604	VBMT 16	M5X0,5X3,5	M3,5X14	T15	
D 9540		✓	32	32	16	170	40	0	0	VBM. 1604	VBMT 16	M5X0,5X3,5	M3,5X14	T15	

### SVHBR ISO



107,5°

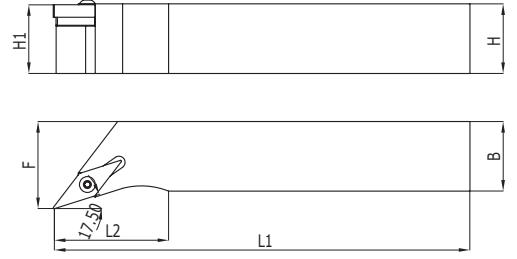

Kesici Uç Uyumluluğu Insert Suitability		Stok Stock	Takım Ölçüleri / Dimension (mm)								Uç Insert	Altlık Shim	Vida Screw	Vida Screw	Anahtar Torx Key
SVHBR ISO			H1	H	B	F	L1	L2	λS	Y0					
SİPARİŞ KODU - R Ordering Code - R	SİPARİŞ KODU - L Ordering Code - L														
D 9474	D 9473	✓	12	12	20	100	20	0	0	VBM. 1103	-	-	M2,5X7	T08	
D 9475	D 9468	✓	16	16	20	100	25	0	0	VBM. 1103	-	-	M2,5X7	T08	
D 9476	D 9469	✓	20	20	25	125	35	0	0	VBM. 1103	-	-	M2,5X7	T08	
D 9477	D 9470	✓	20	20	25	125	35	0	0	VBM. 1604	VBMT 16	M5X0,5X3,5	M3,5X14	T15	
D 9478	D 9471	✓	25	25	32	150	40	0	0	VBM. 1604	VBMT 16	M5X0,5X3,5	M3,5X14	T15	
D 9479	D 9472	✓	32	32	40	170	40	0	0	VBM. 1604	VBMT 16	M5X0,5X3,5	M3,5X14	T15	

### SVJCR ISO



93°

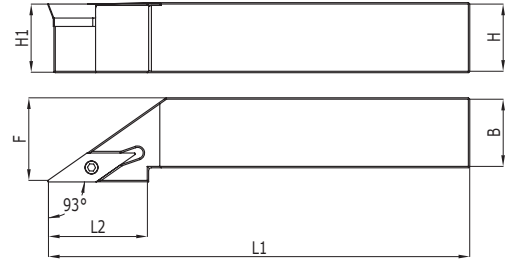

Kesici Uç Uyumluluğu Insert Suitability		Stok Stock	Takım Ölçüleri / Dimension (mm)								Uç Insert	Altlık Shim	Vida Screw	Vida Screw	Anahtar Torx Key
SVJCR ISO			H1	H	B	F	L1	L2	λS	Y0					
SİPARİŞ KODU - R Ordering Code - R	SİPARİŞ KODU - L Ordering Code - L														
D 9507	D 9500	✓	12	12	20	100	20	0	0	VCM. 1103	-	-	M2,5X7	T08	
D 9508	D 9501	✓	16	16	20	100	25	0	0	VCM. 1103	-	-	M2,5X7	T08	
D 9509	D 9502	✓	16	16	20	100	25	0	0	VCM. 1604	VCMT 16	M5X0,5X3,5	M3,5X14	T15	
D 9510	D 9503	✓	20	20	25	125	35	0	0	VCM. 1103	-	-	M2,5X7	T08	
D 9511	D 9504	✓	20	20	25	125	35	0	0	VCM. 1604	VCMT 16	M5X0,5X3,5	M3,5X14	T15	
D 9512	D 9505	✓	25	25	32	150	40	0	0	VCM. 1604	VCMT 16	M5X0,5X3,5	M3,5X14	T15	
D 9513	D 9506	✓	32	32	40	170	40	0	0	VCM. 1604	VCMT 16	M5X0,5X3,5	M3,5X14	T15	

**SVVCN ISO**

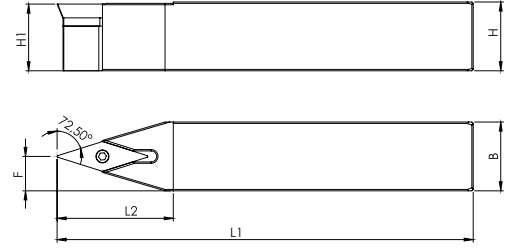

Kesici Uç Uyumluluğu Insert Suitability	Stok Stock	Takım Ölçüleri / Dimension (mm)								Uç İnsert	Altlık Shim	Vida Screw	Vida Screw	Anahtar Torx Key
		H1 H	B	F	L1	L2	λS	Y0						
SVVCN ISO														
SIPARIŞ KODU Ordering Code														
D 9541	✓	12	12	6	100	20	0	0	VCM. 1103	-	-	M2,5X7	T08	
D 9542	✓	16	16	8	100	25	0	0	VCM. 1103	-	-	M2,5X7	T08	
D 9544	✓	16	16	8	100	25	0	0	VCM. 1604	VCMT 16	M5X0,5X3,5	M3,5X14	T15	
D 9543	✓	20	20	10	125	35	0	0	VCM. 1103	-	-	M2,5X7	T08	
D 9545	✓	20	20	10	125	35	0	0	VCM. 1604	VCMT 16	M5X0,5X3,5	M3,5X14	T15	
D 9546	✓	25	25	12,5	150	40	0	0	VCM. 1604	VCMT 16	M5X0,5X3,5	M3,5X14	T15	
D 9547	✓	32	32	16	170	40	0	0	VCM. 1604	VCMT 16	M5X0,5X3,5	M3,5X14	T15	

**SDNCN ISO**

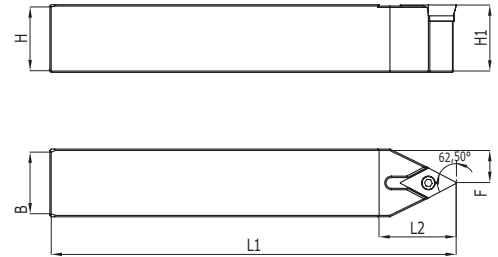

Kesici Uç Uyumluluğu Insert Suitability	Stok Stock	Takım Ölçüleri / Dimension (mm)								Uç İnsert	Altlık Shim	Vida Screw	Vida Screw	Anahtar Torx Key
		H1 H	B	F	L1	L2	λS	Y0						
SDNCN ISO														
SIPARIŞ KODU Ordering Code														
D 7894	✓	8	8	4	100	16	0	0	DC.T 0702	-	-	M2,5X7	T08	
D 7895	✓	10	10	5	100	16	0	0	DC.T 0702	-	-	M2,5X7	T08	
D 7896	✓	12	12	6	100	20	0	0	DC.T 0702	-	-	M2,5X7	T08	
D 7897	✓	16	16	8	100	25	0	0	DC.T 0702	-	-	M2,5X7	T08	
D 7898	✓	16	16	8	100	25	0	0	DC.T 11T3	DCMT 11	M5X0,5X3,5	M3,5X14	T15	
D 7899	✓	20	20	10	125	35	0	0	DC.T 11T3	DCMT 11	M5X0,5X3,5	M3,5X14	T15	
D 7900	✓	25	25	12,5	150	40	0	0	DC.T 11T3	DCMT 11	M5X0,5X3,5	M3,5X14	T15	
D 7901	✓	32	32	16	170	40	0	0	DC.T 11T3	DCMT 11	M5X0,5X3,5	M3,5X14	T15	

### SDJCR ISO



93°

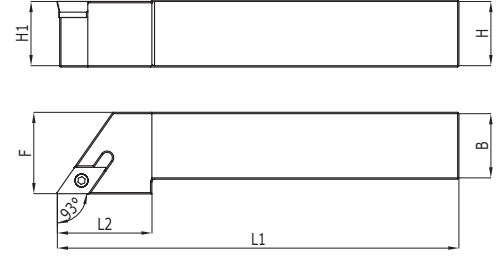

Kesici Uç Uyumluluğu Insert Suitability		Stok Stock	Takım Ölçüleri / Dimension (mm)								Uç Insert	Altlık Shim	Vida Screw	Vida Screw	Anahtar Torx Key
SDJCR ISO			H1	H	B	F	L1	L2	λS	Y0					
SİPARİŞ KODU - R Ordering Code - R	SİPARİŞ KODU - L Ordering Code - L														
D 7884	D 7875	✓	8	8	10	100	16	0	0	DC.T 0702	-	-	M2,5X7	T08	
D 7885	D 7876	✓	10	10	12	100	16	0	0	DC.T 0702	-	-	M2,5X7	T08	
D 7886	D 7877	✓	12	12	16	100	20	0	0	DC.T 0702	-	-	M2,5X7	T08	
D 7887	D 7878	✓	16	16	20	100	25	0	0	DC.T 0702	-	-	M2,5X7	T08	
D 7888	D 7879	✓	16	16	20	100	25	0	0	DC.T 0702	-	-	M2,5X7	T08	
D 12524	D 17023	✓	16	16	20	100	25	0	0	DC.T 11T3	DCMT 11	M5X0,5X3,5	M3,5X14	T15	
D 7889	D 7880	✓	20	20	25	125	35	0	0	DC.T 11T3	DCMT 11	M5X0,5X3,5	M3,5X14	T15	
D 7890	D 7881	✓	25	25	32	150	40	0	0	DC.T 11T3	DCMT 11	M5X0,5X3,5	M3,5X14	T15	
D 7891	D 7882	✓	32	32	40	170	40	0	0	DC.T 11T3	DCMT 11	M5X0,5X3,5	M3,5X14	T15	

### SCLCR ISO



95°

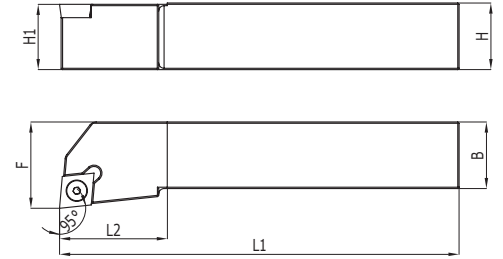

Kesici Uç Uyumluluğu Insert Suitability		Stok Stock	Takım Ölçüleri / Dimension (mm)								Uç Insert	Altlık Shim	Vida Screw	Vida Screw	Anahtar Torx Key
SCLCR ISO			H1	H	B	F	L1	L2	λS	Y0					
SİPARİŞ KODU - R Ordering Code - R	SİPARİŞ KODU - L Ordering Code - L														
D 7811	D 7781	✓	8	8	10	100	20	-10	0	CC.T 0602	-	-	M2,5X7	T08	
D 7812	D 7782	✓	10	10	12	100	20	-10	0	CC.T 0602	-	-	M2,5X7	T08	
D 7813	D 7783	✓	12	12	15	100	20	-10	0	CC.T 0602	-	-	M2,5X7	T08	
D 7822	D 16590	✓	12	12	15	100	20	-8	0	CC.T 09T3	-	-	M3,5X10	T15	
D 7814	D 7784	✓	16	16	20	100	25	-8	0	CC.T 0602	-	-	M2,5X7	T08	
D 7815	D 7785	✓	16	16	20	100	25	-8	0	CC.T 09T3	-	-	M3,5X10	T15	
D 7818	D 7788	✓	16	16	20	100	25	-8	0	CC.T 1204	CCMT 12	M6X0,75X4	M4X16 WLTR	T15	
D 7816	D 7786	✓	20	20	25	125	35	-8	0	CC.T 09T3	-	-	M3,5X10	T15	
D 7819	D 7789	✓	20	20	25	125	35	8	0	CC.T 1204	CCMT 12	M6X0,75X4	M4X16 WLTR	T15	
D 7817	D 7787	✓	25	25	32	150	35	-8	0	CC.T 09T3	-	-	M3,5X10	T15	
D 7820	D 7790	✓	25	25	32	150	35	8	0	CC.T 1204	CCMT 12	M6X0,75X4	M4X16 WLTR	T15	
D 7821	D 7791	✓	32	32	40	170	40	-8	0	CC.T 1204	CCMT 12	M6X0,75X4	M4X16 WLTR	T15	

### SCNCN ISO



50°

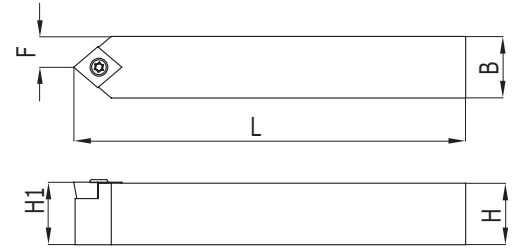

Kesici Uç Uyumluluğu Insert Suitability		Stok Stock	Takım Ölçüleri / Dimension (mm)							Uç Insert	Altılık Shim	Vida Screw	Vida Screw	Anahtar Torx Key
SCNCN ISO			H1	H	B	F	L1	L2	λS	Y0				
SIPARIŞ KODU - R Ordering Code - R	SIPARIŞ KODU - L Ordering Code - L													
D 7852		✓	8	8	4	100	16	0	0	CC.T 0602	-	-	M2,5X7	T08
D 7853		✓	10	10	5	100	16	0	0	CC.T 0602	-	-	M2,5X7	T08
D 7857		✓	12	12	6	100	20	0	0	CC.T 0602	-	-	M2,5X7	T08
D 7858		✓	12	12	6	150	40	0	0	CC.T 09T3	-	-	M3,5X10	T15
D 7854		✓	16	16	8	100	25	0	0	CC.T 09T3	-	-	M3,5X10	T15
D 7855		✓	20	20	10	125	35	0	0	CC.T 09T3	-	-	M3,5X10	T15
D 7856		✓	25	25	12,5	150	40	0	0	CC.T 1204	CCMT 12	M6X0,75X4	M4X16 WLTR	T15

### SSDCN ISO



45°

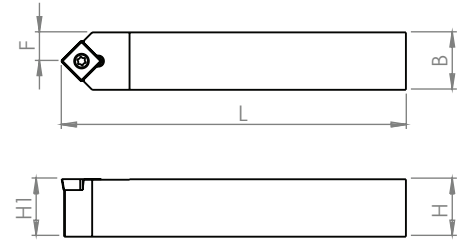

Kesici Uç Uyumluluğu Insert Suitability		Stok Stock	Takım Ölçüleri / Dimension (mm)							Uç Insert	Vida Screw	Anahtar Torx Key
SSDCN ISO			H1	H	B	F	L1	L2	λS	Y0		
SIPARIŞ KODU - R Ordering Code - R	SIPARIŞ KODU - L Ordering Code - L											
D 16781	X	✓	16	16	8	100	25	0	0	SC.T 09	M4X11	T15
D 16488	X	✓	20	20	10	125	35	0	0	SC.T 09	M4X11	T15
D 16490	X	✓	20	20	10	125	35	0	0	SC.T 12	M5X12	T20
D 16489	X	✓	25	25	12,5	150	40	0	0	SC.T 09	M4X11	T15
D 16491	X	✓	25	25	12,5	150	40	0	0	SC.T 12	M5X12	T20

### SRGCR ISO

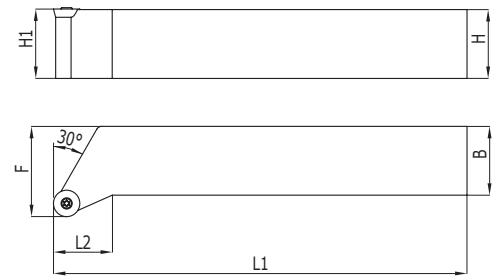

Kesici Uç Uyumluluğu Insert Suitability		Stok Stock	Takım Ölçüleri / Dimension (mm)							Uç Insert	Vida Screw	Anahtar Torx Key
SRGCR ISO			H1	H	B	F	L1	L2	λS	Y0		
SIPARIŞ KODU - R Ordering Code - R	SIPARIŞ KODU - L Ordering Code - L											
D 8249	D 8238	✓	16	16	21	125	25	0	0	RC.T 0803	M3X10	T10
D 8252	D 8241	✓	16	16	21	100	25	0	0	RC.T 10T3	M4X12	T15
D 8256	D 8245	✓	16	16	21	100	25	0	0	RC.T 1204	M4X12	T15
D 8250	D 8239	✓	20	20	25	125	35	0	0	RC.T 0803	M3X10	T10
D 8253	D 8242	✓	20	20	25	125	35	0	0	RC.T 10T3	M4X12	T15
D 8257	D 8246	✓	20	20	25	125	35	0	0	RC.T 1204	M4X12	T15
D 8251	D 8240	✓	25	25	32	150	40	0	0	RC.T 0803	M3X10	T10
D 8254	D 8243	✓	25	25	32	150	35	0	0	RC.T 10T3	M4X12	T15
D 8258	D 8247	✓	25	25	32	150	40	0	0	RC.T 1204	M4X12	T15
D 8255	D 8244	✓	32	32	40	170	40	0	0	RC.T 10T3	M4X12	T15
D 8259	D 8248	✓	32	32	40	170	40	0	0	RC.T 1204	M4X12	T15

### SRDCN ISO

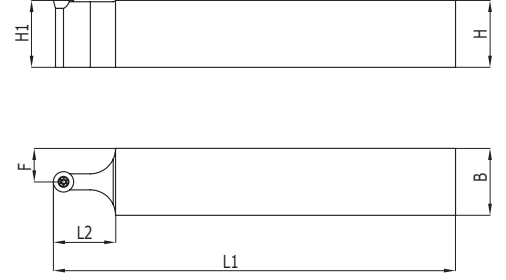

Kesici Uç Uyumluluğu Insert Suitability		Stok Stock	Takım Ölçüleri / Dimension (mm)								Uç Insert	Vida Screw	Anahtar Torx Key
SRDCN ISO			H1 H	B	F	L1	L2	λS	Y0				
SİPARİŞ KODU Ordering Code													
D 21263	X	✓	16	16	8	125	25	0	0	RC.T 0602	M2,5X7	T8	
D 21264	X	✓	20	20	10	125	30	0	0	RC.T 0602	M2,5X7	T8	
D 21265	X	✓	25	25	12,5	150	35	0	0	RC.T 0602	M2,5X7	T8	
D 8227	X	✓	16	16	8	125	25	0	0	RC.T 0803	MX10	T10	
D 8235	X	✓	16	16	8	100	20	0	0	RC.T 10T3	M4X12	T15	
D 8228	X	✓	20	20	10	125	30	0	0	RC.T 0803	M3X10	T10	
D 8230	X	✓	20	20	10	125	30	0	0	RC.T 10T3	M4X12	T15	
D 8232	X	✓	20	20	10	125	30	0	0	RC.T 1204	M4X12	T15	
D 8229	X	✓	25	25	12,5	150	35	0	0	RC.T 0803	M3X10	T10	
D 8231	X	✓	25	25	12,5	150	35	0	0	RC.T 10T3	M4X12	T15	
D 8233	X	✓	25	25	12,5	150	35	0	0	RC.T 1204	M4X12	T15	
D 8234	X	✓	25	25	12,5	150	35	0	0	RC.T 1604	M5X12	T20	
D 8236	X	✓	32	32	16	170	40	0	0	RC.T 10T3	M4X12	T15	
D 8237	X	✓	32	32	16	170	40	0	0	RC.T 1204	M4X12	T15	
D 16803	X	✓	32	32	16	170	40	0	0	RC.T 1604	M5X12	T20	

### SRHCR ISO

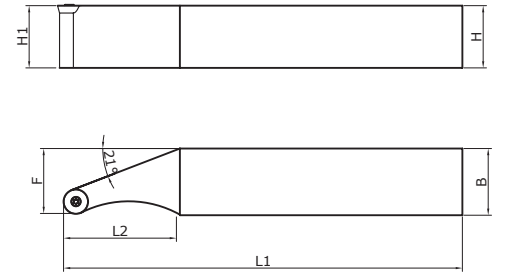

Kesici Uç Uyumluluğu Insert Suitability		Stok Stock	Takım Ölçüleri / Dimension (mm)								Uç Insert	Vida Screw	Anahtar Torx Key
SRHCR ISO			H1 H	B	F	L1	L2	λS	Y0				
SİPARİŞ KODU - R Ordering Code - R	SİPARİŞ KODU - L Ordering Code - L												
D 8269	D 8260	✓	16	16	16	125	25	0	0	RC.T 0803	M3X10	T10	
D 13026	D 15399	✓	16	16	16	125	25	0	0	RC.T 10T3	M4X12	T15	
D 8277	D 8268	✓	16	16	16	125	35	0	0	RC.T 1204	M4X12	T15	
D 8270	D 8261	✓	20	20	20	125	35	0	0	RC.T 0803	M3X10	T10	
D 8272	D 8263	✓	20	20	20	125	35	0	0	RC.T 10T3	M4X12	T15	
D 8274	D 8265	✓	20	20	20	125	35	0	0	RC.T 1204	M4X12	T15	
D 8271	D 8262	✓	25	25	25	150	40	0	0	RC.T 0803	M3X10	T10	
D 8273	D 8264	✓	25	25	25	150	40	0	0	RC.T 10T3	M4X12	T15	
D 8275	D 8266	✓	25	25	25	150	40	0	0	RC.T 1204	M4X12	T15	
D 8276	D 8267		32	32	32	125	35	0	0	RC.T 1204	M4X12	T15	

## STFCR ISO



90°

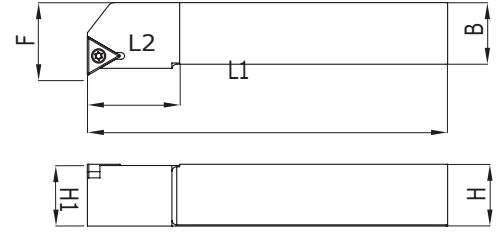

Kesici Uç Uyumluluğu Insert Suitability		Stok Stock	Takım Ölçüleri / Dimension (mm)							Uç Insert	Altlık Shim	Vida Screw	Vida Screw	Anahtar Torx Key
STFCR ISO			H1	H	B	F	L1	L2	λS	Y0				
SIPARIŞ KODU - R Ordering Code - R	SIPARIŞ KODU - L Ordering Code - L													
D 9459	D 9449	✓	12	12	16	100	25	0	0	TC.T 11..	-	-	M2,5X7	T08
D 9460	D 9450	✓	16	16	20	100	25	0	0	TC.T 11..	-	-	M2,5X7	T08
D 9456	D 9446	✓	16	16	20	100	25	0	0	TC.T 16T3	TCMT 16	M5X0,5X3,5	M3,5X14	T15
D 9457	D 9447	✓	20	20	25	125	35	0	0	TC.T 16T3	TCMT 16	M5X0,5X3,5	M3,5X14	T15
D 9458	D 9448	✓	25	25	32	150	40	0	0	TC.T 16T3	TCMT 16	M5X0,5X3,5	M3,5X14	T15

## STJCR ISO

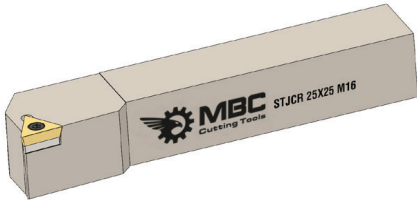

93°

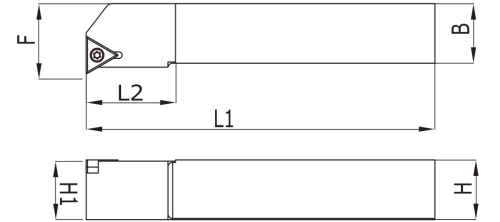

Kesici Uç Uyumluluğu Insert Suitability		Stok Stock	Takım Ölçüleri / Dimension (mm)							Uç Insert	Altlık Shim	Vida Screw	Vida Screw	Anahtar Torx Key
STJCR ISO			H1	H	B	F	L1	L2	λS	Y0				
SIPARIŞ KODU - R Ordering Code - R	SIPARIŞ KODU - L Ordering Code - L													
D 14237	X	✓	16	16	20	100	25	0	0	TC.T 16T3	TCMT 16	M5X0,5X3,5	M3,5X14	T15
D 14123	D 14124	✓	20	20	25	125	35	0	0	TC.T 16T3	TCMT 16	M5X0,5X3,5	M3,5X14	T15
D 14125	D 14126	✓	25	25	32	150	40	0	0	TC.T 16T3	TCMT 16	M5X0,5X3,5	M3,5X14	T15

## ISO DCMT 11 OTOMAT



A90 - J93°

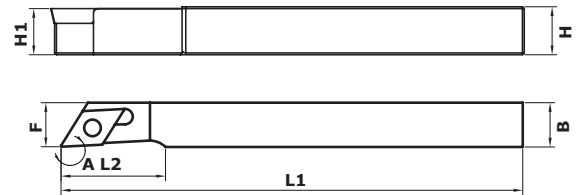

Kesici Uç Uyumluluğu Insert Suitability		Stok Stock	Takım Ölçüleri / Dimension (mm)							Uç Insert	Vida Screw	Anahtar Torx Key	
ISO DCMT 11 OTOMAT			H1	H	B	F	L1	L2	A	λS	Y0		
SIPARIŞ KODU - R Ordering Code - R	SIPARIŞ KODU - L Ordering Code - L												
D 7639	D 7638	✓	12	12	12	125	24	24	90°	0	DC.T 11T3	M3,5X9	T15
D 7641	D 7640	✓	12	12	12	125	24	24	90°	0	DC.T 11T3	M3,5X9	T15
D 12626	D 12625	✓	16	16	12	125	24	24	90°	0	DC.T 11T3	M3,5X9	T15
D 7642	X	✓	12	12	12	125	24	24	90°	0	DC.T 11T3	M3,5X9	T15
D 11233	D 21262	✓	12	12	12	125	24	24	90°	0	DC.T 11T3	M3,5X9	T15
D 17044	D 17046	✓	12	12	12	125	24	24	90°	0	DC.T 11T3	M3,5X9	T15
D 17045	D 17047	✓	16	16	12	125	24	24	90°	0	DC.T 11T3	M3,5X9	T15

### ISO ER

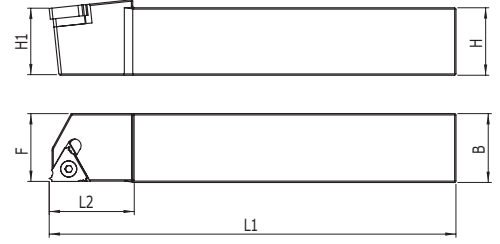

Kesici Uç Uyumluluğu Insert Suitability		Stok Stock	Takım Ölçüleri / Dimension (mm)							Uç Insert	Altlık Shim	Vida Screw	Vida Screw	Anahtar Torx Key	Pabuç Clamp	Vida Screw
ISO ER			H1	H	B	F	L1	L2	λS	Y0						
SIPARIŞ KODU - R Ordering Code - R	SIPARIŞ KODU - L Ordering Code - L															
SER 7980	SEL 7972	✓	12	12	12	100	20	-5,5	0	11 ER	-	-	M2,5X7	T08	-	-
SER 7981	SEL 12911	✓	12	12	12	100	20	-5,5	0	16 ER	ER 16	M5X0,5X3,5	M3,5X14	T15	CK 15	M3,5X9
SER 7982	SEL 7973	✓	16	16	16	100	30	-5,5	0	11 ER	-	-	M2,5X7	T08	-	-
SER 7983	SEL 7974	✓	16	16	16	125	30	-5,5	0	16 ER	ER 16	M5X0,5X3,5	M3,5X14	T15	CK 15	M3,5X9
SER 7984	SEL 7975	✓	20	20	20	125	35	-5,5	0	16 ER	ER 16	M5X0,5X3,5	M3,5X14	T15	CK 15	M3,5X9
SER 12990	X	✓	20	20	20	125	35	-5,5	0	22 ER	ER 22	M6X0,75X4	M4X15	T15	CK 15	M4X11
SER 7985	SEL 7976	✓	25	25	25	150	40	-5,5	0	16 ER	ER 16	M5X0,5X3,5	M3,5X14	T15	CK 15	M3,5X9
SER 7986	SEL 7978	✓	25	25	25	150	40	-5,5	0	22 ER	ER 22	M6X0,75X4	M4X15	T15	CK 15	M4X11
SER 21204	SEL 21205	✓	25	25	25	150	40	-5,5	0	27 ER	ER 27	M6X16	T25			
SER 7987	SEL 7977	✓	32	32	32	170	40	-5,5	0	16 ER	ER 16	M5X0,5X3,5	M3,5X14	T15	CK 15	M3,5X9
SER 7988	SEL 7979	✓	32	32	32	170	40	-5,5	0	22 ER	ER 22	M6X0,75X4	M4X15	T15	CK 15	M4X11
SER 21206	SEL 21207	✓	32	32	32	170	40	-5,5	0	27 ER	ER 27	M6X16	T25			

### TRP ER ZCC

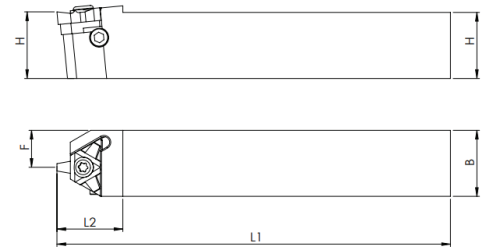
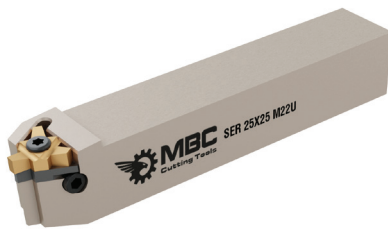

Kesici Uç Uyumluluğu Insert Suitability		Stok Stock	Takım Ölçüleri / Dimension (mm)							Uç Insert	Vida Screw	Anahtar Torx Key	
TRP ER			H1	H	B	F	L1	L2	λS	Y0			
SIPARIŞ KODU - R Ordering Code - R	SIPARIŞ KODU - L Ordering Code - L												
SER 7995	X	✓	25	25	14	150	40	-5,5	0	TRP 22	M4,5X17	T20	
SER 12070	X	✓	25	25	16	150	40	-5,5	0	TRP 22	M5X17	T20	
SER 7996	X	✓	32	32	22	170	40	-5,5	0	TRP 27	M4,5X17	T20	

### ISO IR

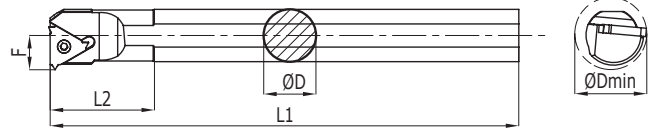

Kesici Uç Uyumluluğu Insert Suitability		Stok Stock	Takım Ölçüleri / Dimension (mm)							Uç Insert	Altlık Shim	Vida Screw	Vida Screw	Anahtar Torx Key	Pabuç Clamp	Vida Screw
SIPARIŞ KODU - R Ordering Code - R	SIPARIŞ KODU - L Ordering Code - L		D	D min	F	L1	L2	λF	P							
S/RL 8018	S/RL 8005	✓	10	13	6	125	25	-15	-1,5	11 IR	-	-	M2,5X7	T08	-	-
S/RL 8019	S/RL 8006	✓	12	15	7	150	25	-15	-1,5	11 IR	-	-	M2,5X7	T08	-	-
S/RL 8020	S/RL 8007	✓	16	13	7,5	180	40	-15	-1,5	11 IR	-	-	M2,5X7	T08	-	-
S/RL 11555	S/RL 11556	✓	16	17	8	180	45	-15	-1,5	IR 16	-	-	M3,5X8	T15	-	-
S/RL 8021	S/RL 8008	✓	16	20	11	180	30	-15	-1,5	11 IR	-	-	M2,5X7	T08	-	-
S/RL 8022	S/RL 8009	✓	16	20	11	180	30	-15	-1,5	IR 16	-	-	M3,5X8	T15	-	-
S/RL 12354	X	✓	20	20	11	200	35	-15	-1,5	IR 16	-	-	M3,5X8	T15	-	-
S/RL 8023	S/RL 8010	✓	20	25	13	200	35	-15	-1,5	IR 16	-	-	M3,5X10	T15	-	-
S/RL 12538	S/RL 11937	✓	20	25	13	200	35	-15	-1,5	IR 16	-	-	M3,5X10	T15	-	-
S/RL 8024	S/RL 8011	✓	25	32	17	250	35	-15	-1,5	IR 16	16 IR	M5X0,5X3,5	M3,5X11	T15	CK 15	M4X11
S/RL 8027	S/RL 8014	✓	25	32	17	250	35	-15	-1,5	IR 22	22 IR	M6X0,75X4	M4X14	T15	CK 15	M4X11
S/RL 21231	S/RL 21232	✓	25	32	17	250	35	-15	-1,5	IR 27	27 IR	M6X16	T25	-	-	-
S/RL 8025	S/RL 8012	✓	32	40	21	300	40	-15	-1,5	IR 16	16 IR	M5X0,5X3,5	M3,5X14	T15	CK 15	M4X11
S/RL 8028	S/RL 8015	✓	32	40	21	300	40	-15	-1,5	IR 22	22 IR	M6X0,75X4	M4X14	T15	CK 15	M4X11
S/RL 21230	S/RL 21228	✓	32	40	21	300	40	-15	-1,5	IR 27	27 IR	M6X16	T25	-	-	-
S/RL 8026	S/RL 8013	✓	40	50	26	400	50	-15	-1,5	IR 16	16 IR	M5X0,5X3,5	M3,5X14	T15	CK 15	M4X11
S/RL 8029	S/RL 8016	✓	40	50	26	400	50	-15	-1,5	IR 22	22 IR	M6X0,75X4	M4X14	T15	CK 15	M4X11
S/RL 21233	S/RL 21234	✓	40	50	26	400	50	-15	-1,5	IR 27	27 IR	M6X16	T25	-	-	-
S/RL 8030	S/RL 8017	✓	50	63	35	450	70	-15	-1,5	IR 22	22 IR	M6X0,75X4	M4X14	T15	CK 15	M4X11
S/RL 21235	S/RL 21236	✓	50	63	35	450	70	-15	-1,5	IR 27	27 IR	M6X16	T25	-	-	-
S/RL 8031	X	✓	60	73	40	450	70	-15	-1,5	IR 22	22 IR	M6X0,75X4	M4X14	T15	CK 15	M4X11

### TRP IR ZCC

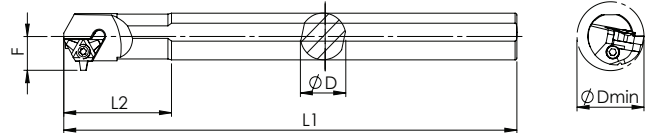

Kesici Uç Uyumluluğu Insert Suitability		Stok Stock	Takım Ölçüleri / Dimension (mm)							Uç Insert	Altlık Shim	Vida Screw	Anahtar Torx Key
SIPARIŞ KODU - R Ordering Code - R	SIPARIŞ KODU - L Ordering Code - L		D	D min	F	L1	L2	λF	P				
S/RL 8032	X	✓	25	33	19	250	60	-12	-3	TRP 22	22	M4,5X14	T15
S/RL 8033	X	✓	32	38	22	300	60	-10	-3	TRP 22	22	M4,5X14	T15
S/RL 8034	X	✓	40	45	26	400	60	-12	-3	TRP 22	22	M4,5X14	T15
S/RL 12277	X	✓	32	40	23	300	60	-14	-3	TRP 27	27	M5X17	T20
S/RL 12416	X	✓	40	50	26	400	60	-12	-3	TRP 27	27	M5X17	T20



## C-SİSTEM DIŞ ÇAP TORNALAMA KATERLERİ

C-SYSTEM EXTERNAL TURNING TOOLHOLDERS

## CTGPR ISO



90°

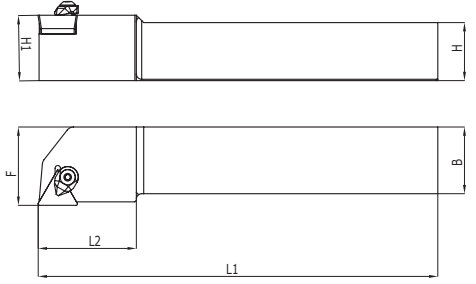

Kesici Uç Uyumluluğu Insert Suitability		Stok Stock	Takım Ölçüleri / Dimension (mm)								Uç Insert	Altlık Shim	Vida Screw	Pabuç Clamp	Vida Screw	Anahtar Allen Key
CTGPR ISO			H1	B	F	L1	L2	λS	Y0							
SİPARİŞ KODU - R Ordering Code - R	SİPARİŞ KODU - L Ordering Code - L															
D 6879	X	✓	16	16	16	100	30	-6	-6	TP.. 1103	-	-	TPKN 11	M5X12	A4	
D 6880	X	✓	16	16	20	100	30	-6	-6	TP.. 1603	TC.. 16	M4X10	TPKN 16	M5X12	A4	
D 6881	X	✓	20	20	25	125	35	-6	-6	TP.. 1603	TC.. 16	M4X10	TPKN 16	M5X12	A4	
D 6882	X	✓	25	25	32	150	40	-6	-6	TP.. 1603	TC.. 16	M4X10	TPKN 16	M5X12	A4	
D 6883	X	✓	25	25	32	150	40	-6	-6	TP.. 2204	-	-	TPKN 22	M5X12	A4	

## CKJNR ISO



93°

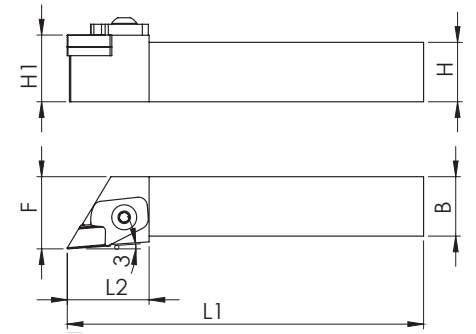

Kesici Uç Uyumluluğu Insert Suitability		Stok Stock	Takım Ölçüleri / Dimension (mm)								Uç Insert	Altlık Shim	Vida Screw	Pabuç Clamp	Vida Screw	Anahtar Allen Key
CKJNR ISO			H1	B	F	L1	L2	λS	Y0							
SİPARİŞ KODU - R Ordering Code - R	SİPARİŞ KODU - L Ordering Code - L															
D 6864	D 6858	✓	20	20	25	125	35	-6	-6	KNUX 1604	KNUX 16	M3X10	C160105	M6X22	A5	
D 6865	D 6859	✓	25	25	32	150	40	-6	-6	KNUX 1604	KNUX 16	M3X10	C160105	M6X22	A5	
D 6866	D 6860	✓	32	32	40	170	40	-6	-6	KNUX 1604	KNUX 16	M3X10	C160105	M6X22	A5	
D 6867	D 6861	✓	40	40	50	200	45	-6	-6	KNUX 1604	KNUX 16	M3X10	C160105	M6X22	A5	

### TDJNR ISO



93°

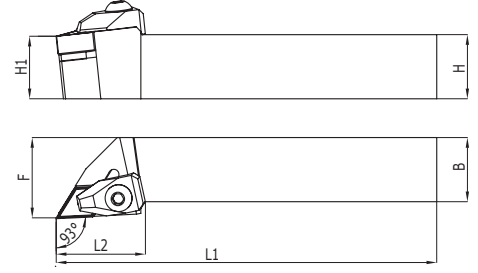

Kesici Uç Uyumluluğu Insert Suitability		Stok Stock	Takım Ölçüleri / Dimension (mm)							Uç Insert	Altlık Shim	Vida Screw	Pabuç Clamp	Vida Screw	Anahtar Allen Key
TDJNR ISO			H1	H	B	F	L1	L2	λS	γ0					
SİPARİŞ KODU - R Ordering Code - R	SİPARİŞ KODU - L Ordering Code - L														
D 9623	D 9616	✓	16	16	21	125	30	-6	-6	DNM. 1104	DNMG 11	M4X11 T15	T110105	M5X23	A3
D 9630	D 17218	✓	16	16	21	125	30	-6	-6	DNM. 1506	DNMG 15	M4X10 A2,5	T150105	M6X27	A3
D 9624	D 9617	✓	20	20	25	125	35	-6	-6	DNM. 1104	DNMG 11	M4X11 T15	T110105	M5X23	A3
D 9626	D 9619	✓	20	20	25	125	35	-6	-6	DNM. 1506	DNMG 15	M4X10 A2,5	T150105	M6X27	A3
D 9625	D 9618	✓	25	25	32	150	40	-6	-6	DNM. 1104	DNMG 11	M4X11 T15	T110105	M5X23	A3
D 9627	D 9620	✓	25	25	32	150	40	-6	-6	DNM. 1506	DNMG 15	M4X10 A2,5	T150105	M6X27	A3
D 9628	D 9621	✓	32	32	40	170	40	-6	-6	DNM. 1506	DNMG 15	M4X10 A2,5	T150105	M6X27	A3
D 9629	D 9622	✓	40	40	50	200	45	-6	-6	DNM. 1506	DNMG 15	M4X10 A2,5	T150105	M6X27	A3

### TDHNR ISO

NEW



107,5°

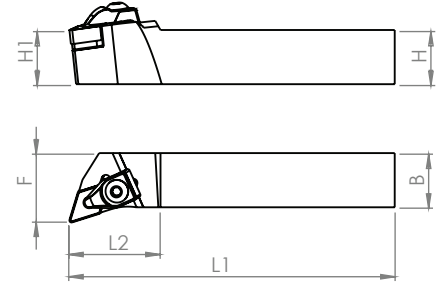

Kesici Uç Uyumluluğu Insert Suitability		Stok Stock	Takım Ölçüleri / Dimension (mm)							Uç Insert	Altlık Shim	Vida Screw	Pabuç Clamp	Vida Screw	Anahtar Allen Key
TDHNR ISO			H1	H	B	F	L1	L2	λS	γ0					
SİPARİŞ KODU - R Ordering Code - R	SİPARİŞ KODU - L Ordering Code - L														
D 16479	D 16480	✓	20	20	25	125	35	-6	-6	DNM. 1506	DNMG 15	M4X10 A2,5	T150105	M6X27	A3
D 16481	D 16483	✓	25	25	32	150	40	-6	-6	DNM. 1506	DNMG 15	M4X10 A2,5	T150105	M6X27	A3
D 16482	D 16484	✓	32	32	40	170	40	-6	-6	DNM. 1506	DNMG 15	M4X10 A2,5	T150105	M6X27	A3

### TDNNN ISO



62,5°

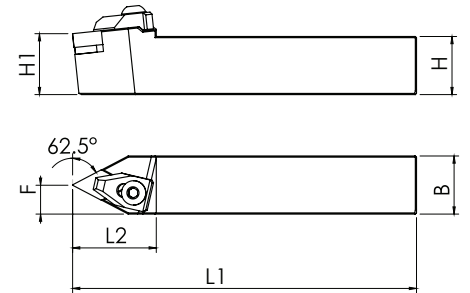

Kesici Uç Uyumluluğu Insert Suitability		Stok Stock	Takım Ölçüleri / Dimension (mm)							Uç Insert	Altlık Shim	Vida Screw	Pabuç Clamp	Vida Screw	Anahtar Allen Key
TDNNN ISO			H1	H	B	F	L1	L2	λS	γ0					
SİPARİŞ KODU Ordering Code															
D 9633		✓	16	16	8	125	30	-10	0	DNM. 1104	DNMG 11	M4X11 T15	T110105	M5X23	A3
D 9634		✓	20	20	10	125	35	-10	0	DNM. 1104	DNMG 11	M4X11 T15	T110105	M5X23	A3
D 9635		✓	25	25	12,5	150	40	-10	0	DNM. 1104	DNMG 11	M4X11 T15	T110105	M5X23	A3
D 9636		✓	20	20	10	125	35	-10	0	DNM. 1506	DNMG 15	M4X10 A2,5	T150105	M6X27	A3
D 9637		✓	25	25	12,5	150	40	-10	0	DNM. 1506	DNMG 15	M4X10 A2,5	T150105	M6X27	A3
D 9638		✓	32	32	18	170	40	-10	0	DNM. 1506	DNMG 15	M4X10 A2,5	T150105	M6X27	A3
D 9639		✓	40	40	20	200	45	-10	0	DNM. 1506	DNMG 15	M4X10 A2,5	T150105	M6X27	A3

## TTGNR ISO



90°

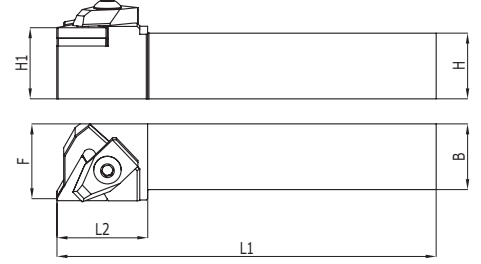

Kesici Uç Uyumluluğu Insert Suitability		Stok Stock	Takım Ölçüleri / Dimension (mm)							Uç Insert	Altık Shim	Vida Screw	Pabuç Clamp	Vida Screw	Anahtar Allen Key
SIPARIŞ KODU - R Ordering Code - R	SIPARIŞ KODU - L Ordering Code - L		H1	H	B	F	L1	L2	λS	γ0					
D 10583	D 10577	✓	20	20	25	125	35	-6	-6	TNMG 1604	TNMG 16	M4X10 A2,5	T160105	M5X23	A3
D 10584	D 10578	✓	25	25	32	150	40	-6	-6	TNMG 1604	TNMG 16	M4X10 A2,5	T160105	M5X23	A3
D 10585	D 10579	✓	20	20	25	125	40	-6	-6	TNMG 2204	TNMG 22	M4X10 A2,5	T220105	M6X27	A3
D 10586	D 10580	✓	25	25	32	150	40	-6	-6	TNMG 2204	TNMG 22	M4X10 A2,5	T220105	M6X27	A3
D 10587	D 10581	✓	32	32	40	170	40	-6	-6	TNMG 2204	TNMG 22	M4X10 A2,5	T220105	M6X27	A3
D 10588	D 10582	✓	40	40	50	200	45	-6	-6	TNMG 2204	TNMG 22	M4X10 A2,5	T220105	M6X27	A3

## TTJNR ISO



93°

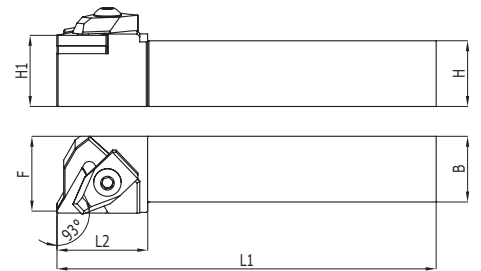

Kesici Uç Uyumluluğu Insert Suitability		Stok Stock	Takım Ölçüleri / Dimension (mm)							Uç Insert	Altık Shim	Vida Screw	Pabuç Clamp	Vida Screw	Anahtar Allen Key
SIPARIŞ KODU - R Ordering Code - R	SIPARIŞ KODU - L Ordering Code - L		H1	H	B	F	L1	L2	λS	γ0					
D 10596	D 10589	✓	16	16	21	125	30	-6	-6	TNMG 1604	TNMG 16	M4X10 A2,5	T160105	M5X23	A3
D 10597	D 10590	✓	20	20	25	125	35	-6	-6	TNMG 1604	TNMG 16	M4X10 A2,5	T160105	M5X23	A3
D 10598	D 10591	✓	25	25	32	150	40	-6	-6	TNMG 1604	TNMG 16	M4X10 A2,5	T160105	M5X23	A3
D 10599	D 10592	✓	20	20	25	125	35	-6	-6	TNMG 2204	TNMG 22	M4X10 A2,5	T220105	M6X27	A3
D 10600	D 10593	✓	25	25	32	150	40	-6	-6	TNMG 2204	TNMG 22	M4X10 A2,5	T220105	M6X27	A3
D 10601	D 10594	✓	32	32	40	170	40	-6	-6	TNMG 2204	TNMG 22	M4X10 A2,5	T220105	M6X27	A3
D 10602	D 10595	✓	40	40	50	200	45	-6	-6	TNMG 2204	TNMG 22	M4X10 A2,5	T220105	M6X27	A3

### TSLNR ISO

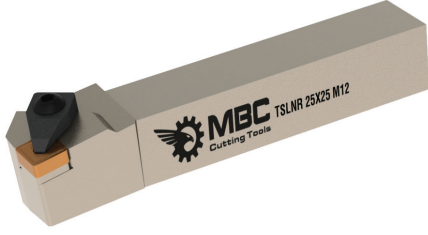

95°

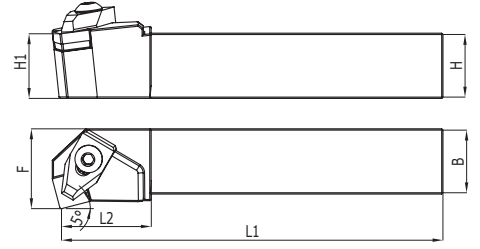

Kesici Uç Uyumluluğu Insert Suitability		Stok Stock	Takım Ölçüleri / Dimension (mm)								Uç Insert	Altılık Shim	Vida Screw	Pabuç Clamp	Vida Screw	Anahtar Allen Key
TSLNR ISO			H1	H	B	F	L1	L2	λS	Y0						
SİPARİŞ KODU - R Ordering Code - R	SİPARİŞ KODU - L Ordering Code - L															
D 10542	D 10534	✓	20	20	25	125	35	-6	-6	SNMG 1204	SNMG 12	M4X10 A2,5	T120105	M6X27	A3	
D 10543	D 10535	✓	25	25	32	150	40	-6	-6	SNMG 1204	SNMG 12	M4X10 A2,5	T120105	M6X27	A3	
D 10544	D 10536	✓	32	32	40	170	40	-6	-6	SNMG 1204	SNMG 12	M4X10 A2,5	T120105	M6X27	A3	
D 10546	D 10538	✓	32	32	40	170	40	-6	-6	SNMG 1506	SNMG 15	M5X10	T160105	M6X27	A3	
D 10548	D 10540	✓	32	32	40	170	40	-6	-6	SNMG 1906	SNMG 19	M5X10	T190105	M8X25	A5	
D 10547	D 10539	✓	40	40	50	170	40	-6	-6	SNMG 1506	SNMG 15	M5X10	T160105	M6X27	A3	
D 10545	D 10537	✓	40	40	50	200	45	-6	-6	SNMG 1906	SNMG 19	M5X10	T190105	M8X25	A5	

### TSKNR ISO



75°

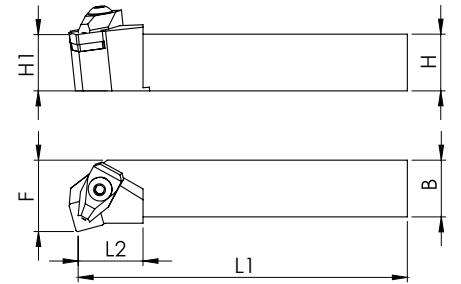

Kesici Uç Uyumluluğu Insert Suitability		Stok Stock	Takım Ölçüleri / Dimension (mm)								Uç Insert	Altılık Shim	Vida Screw	Pabuç Clamp	Vida Screw	Anahtar Allen Key
TSKNR ISO			H1	H	B	F	L1	L2	λS	Y0						
SİPARİŞ KODU - R Ordering Code - R	SİPARİŞ KODU - L Ordering Code - L															
D 10527	D 10519	✓	20	20	25	125	35	-6	-6	SNMG 1204	SNMG 12	M4X10 A2,5	T120105	M6X27	A3	
D 10528	D 10520	✓	25	25	32	150	40	-6	-6	SNMG 1204	SNMG 12	M4X10 A2,5	T120105	M6X27	A3	
D 10531	D 10523	✓	32	32	40	170	40	-6	-6	SNMG 1506	SNMG 15	M5X10	T160105	M6X27	A3	
D 10533	D 10525	✓	40	40	50	200	45	-6	-6	SNMG 1906	SNMG 19	M5X10	T190105	M8X25	A5	

## TSRNR ISO



15°

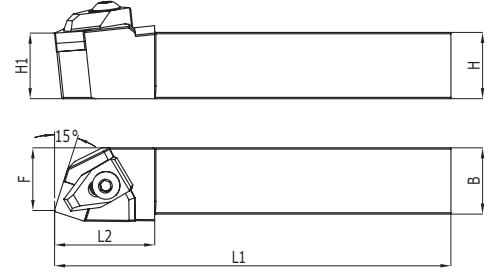

Kesici Uç Uyumluluğu Insert Suitability		Stok Stock	Takım Ölçüleri / Dimension (mm)							Uç Insert	Altlık Shim	Vida Screw	Pabuç Clamp	Vida Screw	Anahtar Allen Key
TSRNR ISO			H1	H	B	F	L1	L2	λS	Y0					
SİPARİŞ KODU - R Ordering Code - R	SİPARİŞ KODU - L Ordering Code - L														
D 10557	D 10550	✓	20	20	19	125	35	-6	-6	SNMG 1204	SNMG 12	M4X10 A2,5	T120105	M6X27	A3
D 10558	D 10551	✓	25	25	24	150	40	-6	-6	SNMG 1204	SNMG 12	M4X10 A2,5	T120105	M6X27	A3
D 10561	D 10554	✓	32	32	30	170	40	-6	-6	SNMG 1204	SNMG 12	M4X10 A2,5	T120105	M6X27	A3
D 10559	D 10552	✓	32	32	30	170	40	-6	-6	SNMG 1506	SNMG 15	M5X10	T160105	M6X27	A3
D 10562	D 10555	✓	32	32	30	170	40	-6	-6	SNMG 1906	SNMG 19	M5X10	T190105	M8X25	A5
D 10563	D 10556	✓	40	40	38	200	45	-6	-6	SNMG 1506	SNMG 15	M5X10	T160105	M6X27	A3
D 10560	D 10553	✓	40	40	38	200	45	-6	-6	SNMG 1906	SNMG 19	M5X10	T190105	M8X25	A5

## TSDNN ISO



45°

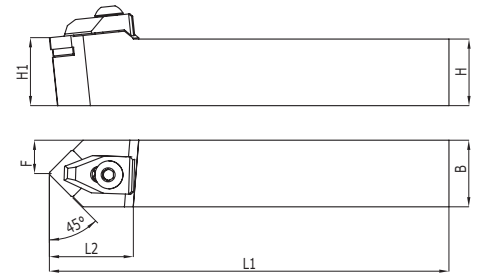

Kesici Uç Uyumluluğu Insert Suitability		Stok Stock	Takım Ölçüleri / Dimension (mm)							Uç Insert	Altlık Shim	Vida Screw	Pabuç Clamp	Vida Screw	Anahtar Allen Key
TSDNN ISO			H1	H	B	F	L1	L2	λS	Y0					
SİPARİŞ KODU Ordering Code															
D 10511		✓	20	20	10	125	35	-10	0	SNMG 1204	SNMG 12	M4X10 A2,5	T120105	M6X27	A3
D 10512		✓	25	25	12,5	150	40	-10	0	SNMG 1204	SNMG 12	M4X10 A2,5	T120105	M6X27	A3
D 10515		✓	32	32	16	170	40	-10	0	SNMG 1204	SNMG 12	M4X10 A2,5	T120105	M6X27	A3
D 10513		✓	32	32	16	170	40	-10	0	SNMG 1506	SNMG 15	M5X10	T160105	M6X27	A3
D 10516		✓	32	32	16	170	40	-10	0	SNMG 1906	SNMG 19	M5X10	T190105	M8X25	A5
D 10517		✓	40	40	20	200	45	-10	0	SNMG 1506	SNMG 15	M5X10	T160105	M6X27	A3
D 10514		✓	40	40	20	200	45	-10	0	SNMG 1906	SNMG 19	M5X10	T190105	M8X25	A5

### TSSNR ISO



45°

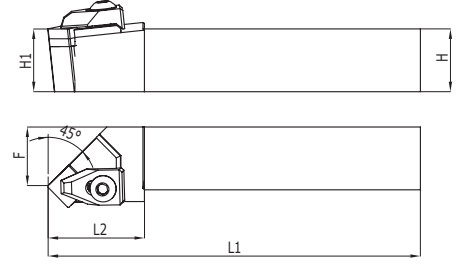

Kesici Uç Uyumluluğu Insert Suitability		Stok Stock	Takım Ölçüleri / Dimension (mm)							Uç Insert	Altlık Shim	Vida Screw	Pabuç Clamp	Vida Screw	Anahtar Allen Key
TSSNR ISO			H1	H	B	F	L1	L2	λS	Y0					
SİPARİŞ KODU - R Ordering Code - R	SİPARİŞ KODU - L Ordering Code - L														
D 10570	D 10564	✓	20	20	19	125	35	-6	-6	SNMG 1204	SNMG 12	M4X10 A2,5	T120105	M6X27	A3
D 10571	D 10565	✓	25	25	24	150	40	-6	-6	SNMG 1204	SNMG 12	M4X10 A2,5	T120105	M6X27	A3
D 10574	D 10568	✓	32	32	30	170	40	-6	-6	SNMG 1204	SNMG 12	M4X10 A2,5	T120105	M6X27	A3
D 10572	D 10566	✓	32	32	30	170	40	-6	-6	SNMG 1506	SNMG 15	M5X10	T160105	M6X27	A3
D 10575	D 10569	✓	32	32	30	170	40	-6	-6	SNMG 1906	SNMG 19	M5X10	T190105	M8X25	A5
D 10573	D 10567	✓	40	40	38	200	45	-6	-6	SNMG 1906	SNMG 19	M5X10	T190105	M8X25	A5

### TWLN R ISO



95°

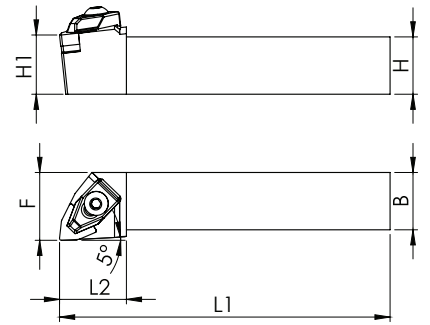

Kesici Uç Uyumluluğu Insert Suitability		Stok Stock	Takım Ölçüleri / Dimension (mm)							Uç Insert	Altlık Shim	Vida Screw	Pabuç Clamp	Vida Screw	Anahtar Allen Key
TWLN R ISO			H1	H	B	F	L1	L2	λS	Y0					
SİPARİŞ KODU - R Ordering Code - R	SİPARİŞ KODU - L Ordering Code - L														
D 10630	D 10617	✓	16	16	21	125	30	-6	-6	WNMG 0604	WNMG 06	M4X10	T060105	M5X23	A3
D 10631	D 10618	✓	20	20	25	125	35	-6	-6	WNMG 0604	WNMG 06	M4X10	T060105	M5X23	A3
D 10633	D 10620	✓	20	20	25	125	35	-6	-6	WNMG 0804	WNMG 08	M4X10	T080105	M6X27	A3
D 10632	D 10619	✓	25	25	32	150	40	-6	-6	WNMG 0604	WNMG 06	M4X10	T060105	M5X23	A3
D 10634	D 10621	✓	25	25	32	150	40	-6	-6	WNMG 0804	WNMG 08	M4X10	T080105	M6X27	A3
D 10635	D 10622	✓	32	32	40	170	40	-6	-6	WNMG 0804	WNMG 08	M4X10	T080105	M6X27	A3
D 10636	D 10623	✓	40	40	50	200	45	-6	-6	WNMG 0804	WNMG 08	M4X10	T080105	M6X27	A3

## TVJNR ISO



93°

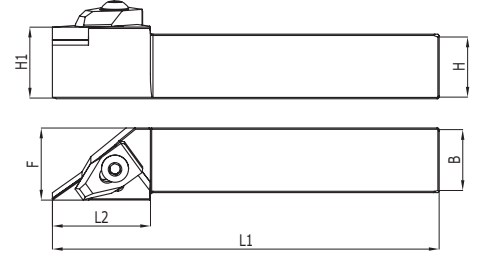

Kesici Uç Uyumluluğu Insert Suitability		Stok Stock	Takım Ölçüleri / Dimension (mm)							Uç Insert	Altık Shim	Vida Screw	Pabuç Clamp	Vida Screw	Anahtar Allen Key
TVJNR ISO			H1	H	B	F	L1	L2	λS	Y0					
SIPARIŞ KODU - R Ordering Code - R	SIPARIŞ KODU - L Ordering Code - L														
D 10607	D 10603	✓	16	16	25	125	35	-6	-6	VNMG 1604	VNMG 16	M4X11 T15	T160105	M6X27	A3
D 10608	D 12850	✓	20	20	25	125	35	-6	-6	VNMG 1604	VNMG 16	M4X11 T15	T160105	M6X27	A3
D 10609	D 10604	✓	25	25	32	150	40	-6	-6	VNMG 1604	VNMG 16	M4X11 T15	T160105	M6X27	A3
D 10610	D 10605	✓	32	32	40	170	40	-6	-6	VNMG 1604	VNMG 16	M4X11 T15	T160105	M6X27	A3
D 10611	D 10606	✓	40	40	50	200	45	-6	-6	VNMG 1604	VNMG 16	M4X11 T15	T160105	M6X27	A3

## TVNNN ISO



72,5°

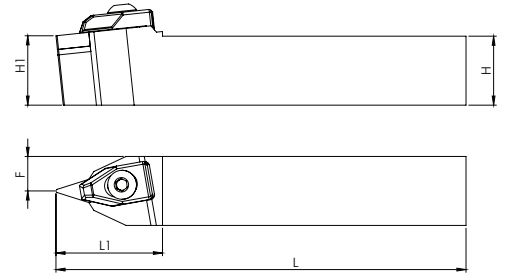

Kesici Uç Uyumluluğu Insert Suitability		Stok Stock	Takım Ölçüleri / Dimension (mm)							Uç Insert	Altık Shim	Vida Screw	Pabuç Clamp	Vida Screw	Anahtar Allen Key
TVNNN ISO			H1	H	B	F	L1	L2	λS	Y0					
SIPARIŞ KODU Ordering Code															
D 10612		✓	20	20	10	125	30	-10	0	VNMG 1604	VNMG 16	M4X11 T15	T160105	M6X27	A3
D 10613		✓	25	25	12,5	150	35	-10	0	VNMG 1604	VNMG 16	M4X11 T15	T160105	M6X27	A3
D 10614		✓	32	32	16	170	40	-10	0	VNMG 1604	VNMG 16	M4X11 T15	T160105	M6X27	A3
D 10615		✓	40	40	16	170	40	-10	0	VNMG 1604	VNMG 16	M4X11 T15	T160105	M6X27	A3

### TCLNR ISO



90°

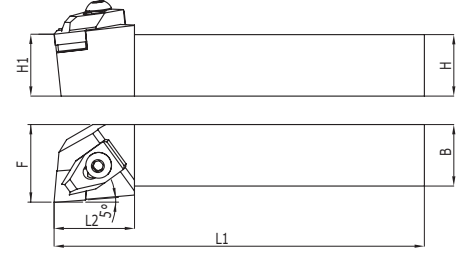

Kesici Uç Uyumluluğu Insert Suitability		Stok Stock	Takım Ölçüleri / Dimension (mm)							Uç Insert	Altılık Shim	Vida Screw	Pabuç Clamp	Vida Screw	Anahtar Allen Key
TCLNR ISO			H1	H	B	F	L1	L2	λS	Y0					
SIPARIŞ KODU - R Ordering Code - R	SIPARIŞ KODU - L Ordering Code - L														
D 9591	D 9575	✓	16	16	25	100	35	-6	-6	CNMG 1204	CNMG 12	M4X10	T120105	M6X27	A3
D 9583	D 9567	✓	20	20	25	125	35	-6	-6	CNMG 1204	CNMG 12	M4X10	T120105	M6X27	A3
D 9584	D 9568	✓	25	25	32	150	40	-6	-6	CNMG 1204	CNMG 12	M4X10	T120105	M6X27	A3
D 9586	D 9570	✓	25	25	32	150	40	-6	-6	CNMG 1606	CNMG 16	M5X10	T160105	M6X27	A3
D 9585	D 9569	✓	32	32	40	170	40	-6	-6	CNMG 1204	CNMG 12	M4X10	T120105	M6X27	A3
D 9587	D 9571	✓	32	32	40	170	40	-6	-6	CNMG 1606	CNMG 16	M5X10	T160105	M6X27	A3
D 9588	D 9572	✓	32	32	40	170	40	-6	-6	CNMG 1906	CNMG 19	M5X10	T190105	M8X25	A5
D 9590	D 9574	✓	40	40	50	200	45	-6	-6	CNMG 1606	CNMG 16	M5X10	T160105	M6X27	A3
D 9589	D 9573	✓	40	40	50	200	45	-6	-6	CNMG 1906	CNMG 19	M5X10	T190105	M8X25	A5

### TCBNR ISO



75°

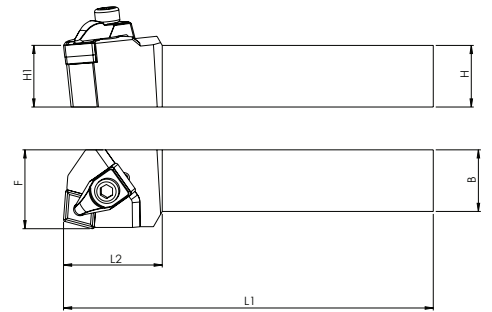

Kesici Uç Uyumluluğu Insert Suitability		Stok Stock	Takım Ölçüleri / Dimension (mm)							Uç Insert	Altılık Shim	Vida Screw	Pabuç Clamp	Vida Screw	Anahtar Allen Key
TCBNR ISO			H1	H	B	F	L1	L2	λS	Y0					
SIPARIŞ KODU - R Ordering Code - R	SIPARIŞ KODU - L Ordering Code - L														
D 12797	D 12483	✓	20	20	25	125	35	-6	-6	CNMG 1204	CNMG 12	M4X10	T120105	M6X27	A3
D 9563	D 9560	✓	25	25	32	150	35	-6	-6	CNMG 1204	CNMG 12	M4X10	T120105	M6X27	A3
D 12803	D 12804	✓	32	32	40	170	40	-6	-6	CNMG 1204	CNMG 12	M4X10	T120105	M6X27	A3
D 12805	D 12806	✓	32	32	40	170	40	-6	-6	CNMG 1606	CNMG 16	M5X10	T160105	M6X27	A3
D 9564	D 9561	✓	32	32	40	170	40	-6	-6	CNMG 1906	CNMG 19	M5X10	T190105	M8X25	A5
D 9565	D 9562	✓	40	40	50	200	40	-6	-6	CNMG 1906	CNMG 19	M5X10	T190105	M8X25	A5

### TCKNR ISO



75°

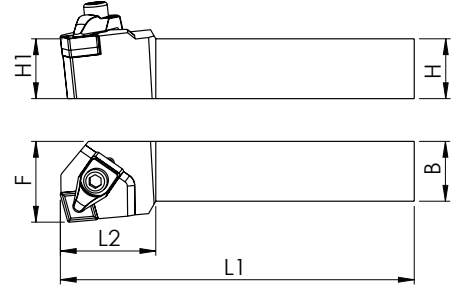

Kesici Uç Uyumluluğu Insert Suitability		Stok Stock	Takım Ölçüleri / Dimension (mm)							Uç Insert	Altık Shim	Vida Screw	Pabuç Clamp	Vida Screw	Anahtar Allen Key
TCKNR ISO			H1	H	B	F	L1	L2	λS	γ0					
SİPARİŞ KODU - R Ordering Code - R	SİPARİŞ KODU - L Ordering Code - L														
D 11210	D 9566	✓	25	25	32	150	35	-6	-6	CNMG 1204	CNMG 12	M4X10	T120105	M6X27	A3
D 11212	D 11213	✓	25	25	32	150	35	-6	-6	CNMG 1606	CNMG 16	M5X10	T160105	M6X27	A3
D 14149	D 16840	✓	32	32	40	170	40	-6	-6	CNMG 1204	CNMG 12	M4X10	T120105	M6X27	A3
D 11276	D 11214	✓	32	32	40	170	40	-6	-6	CNMG 1606	CNMG 16	M5X10	T160105	M6X27	A3

### TCMNN ISO



50°

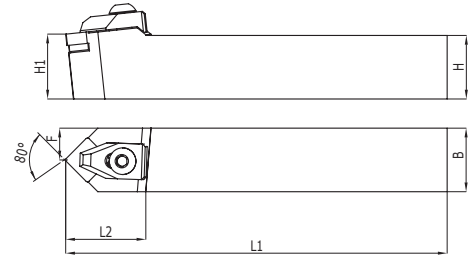

Kesici Uç Uyumluluğu Insert Suitability		Stok Stock	Takım Ölçüleri / Dimension (mm)							Uç Insert	Altık Shim	Vida Screw	Pabuç Clamp	Vida Screw	Anahtar Allen Key
TCMNN ISO			H1	H	B	F	L1	L2	λS	γ0					
SİPARİŞ KODU Ordering Code															
D 9601		✓	20	20	10	125	35	-10	0	CNMG 1204	CNMG 12	M4X10	T120105	M6X27	A3
D 9602		✓	25	25	12,5	150	40	-10	0	CNMG 1204	CNMG 12	M4X10	T120105	M6X27	A3
D 9603		✓	32	32	16	170	40	-10	0	CNMG 1204	CNMG 12	M4X10	T120105	M6X27	A3
D 12912		✓	32	32	16	170	40	-10	0	CNMG 1606	CNMG 16	M5X10	T160105	M6X27	A3
D 9604		✓	32	32	16	170	40	-10	0	CNMG 1906	CNMG 19	M5X10	T190105	M8X25	A5
D 9605		✓	40	40	20	250	40	-10	0	CNMG 1906	CNMG 19	M5X10	T190105	M8X25	A5

### TCZNN ISO



40°

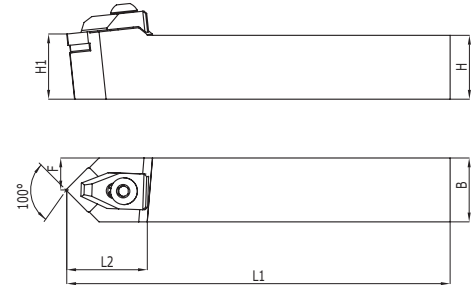

Kesici Uç Uyumluluğu Insert Suitability		Stok Stock	Takım Ölçüleri / Dimension (mm)							Uç Insert	Altık Shim	Vida Screw	Pabuç Clamp	Vida Screw	Anahtar Allen Key
TCZNN ISO			H1	H	B	F	L1	L2	λS	γ0					
SİPARİŞ KODU Ordering Code															
D 9611		✓	20	20	10	125	35	-10	0	CNMG 1204	CNMG 12	M4X10	T120105	M6X27	A3
D 9612		✓	25	25	12,5	150	40	-10	0	CNMG 1204	CNMG 12	M4X10	T120105	M6X27	A3
D 9613		✓	32	32	16	170	40	-10	0	CNMG 1204	CNMG 12	M4X10	T120105	M6X27	A3
D 12267		✓	32	32	16	170	40	-10	0	CNMG 1606	CNMG 16	M5X10	T160105	M6X27	A3
D 9614		✓	32	32	16	170	40	-10	0	CNMG 1906	CNMG 19	M5X10	T190105	M8X25	A5
D 9615		✓	40	40	20	200	40	-10	0	CNMG 1906	CNMG 19	M5X10	T190105	M8X25	A5

### MTJNR ISO



93°

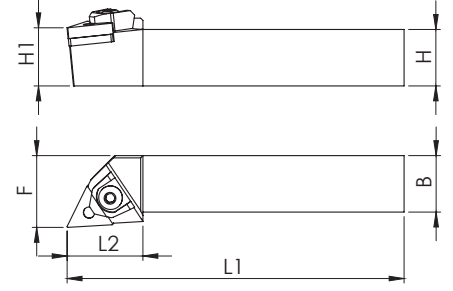

Kesici Uç Uyumluluğu Insert Suitability		Stok Stock	Takım Ölçüleri / Dimension (mm)							Uç Insert	Altlık Shim	Vida Screw	Pabuç Clamp	Vida Screw	Anahtar Allen Key
SIPARIŞ KODU - R Ordering Code - R	SIPARIŞ KODU - L Ordering Code - L		H1	H	B	F	L1	L2	λS	Y0					
D 7551	D 7544	✓	16	16	20	125	35	-6	-6	TNMG 1604	TNMG 16	5X3,6X15	M160105	M6X27	A3
D 7552	D 7545	✓	20	20	25	125	35	-6	-6	TNMG 1604	TNMG 16	5X3,6X15	M160105	M6X27	A3
D 7553	D 7546	✓	25	25	32	150	40	-6	-6	TNMG 1604	TNMG 16	5X3,6X15	M160105	M6X27	A3
D 7554	D 7547	✓	32	32	40	170	40	-6	-6	TNMG 1604	TNMG 16	5X3,6X15	M160105	M6X27	A3
D 7555	D 7548	✓	25	25	32	150	40	-6	-6	TNMG 2204	TNMG 22	6X5X15	M220105	M6X27	A3
D 7556	D 7549	✓	32	32	40	170	40	-6	-6	TNMG 2204	TNMG 22	6X5X15	M220105	M6X27	A3
D 7557	D 7550	✓	40	40	50	200	45	-6	-6	TNMG 2204	TNMG 22	6X5X15	M220105	M6X27	A3

### MTENN ISO



60°

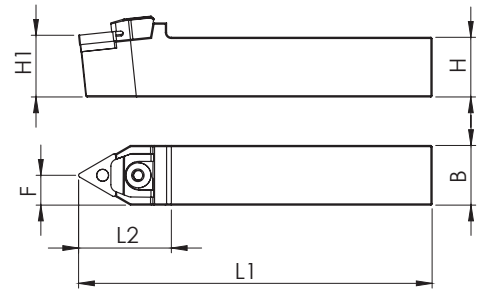

Kesici Uç Uyumluluğu Insert Suitability		Stok Stock	Takım Ölçüleri / Dimension (mm)							Uç Insert	Altlık Shim	Vida Screw	Pabuç Clamp	Vida Screw	Anahtar Allen Key
SIPARIŞ KODU Ordering Code			H1	H	B	F	L1	L2	λS	Y0					
D 7537		✓	16	16	8	125	35	-10	0	TNMG 1604	TNMG 16	5X3,6X15	M160105	M6X27	A3
D 7538		✓	20	20	10	125	35	-10	0	TNMG 1604	TNMG 16	5X3,6X15	M160105	M6X27	A3
D 7539		✓	25	25	12,5	150	40	-10	0	TNMG 1604	TNMG 16	5X3,6X15	M160105	M6X27	A3
D 7540		✓	32	32	16	170	40	-10	0	TNMG 1604	TNMG 16	5X3,6X15	M160105	M6X27	A3
D 7541		✓	25	25	12,5	150	40	-10	0	TNMG 2204	TNMG 22	6X5X15	M220105	M6X27	A3
D 7542		✓	32	32	16	170	40	-10	0	TNMG 2204	TNMG 22	6X5X15	M220105	M6X27	A3
D 7543		✓	40	40	20	200	45	-10	0	TNMG 2204	TNMG 22	6X5X15	M220105	M6X27	A3

### MWLNr ISO



95°

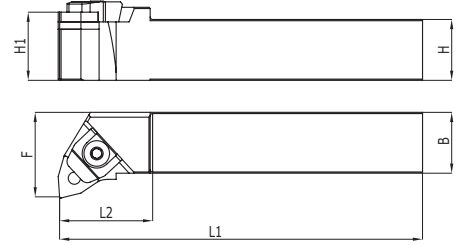

Kesici Uç Uyumluluğu Insert Suitability		Stok Stock	Takım Ölçüleri / Dimension (mm)								Uç Insert	Altlık Shim	Vida Screw	Pabuç Clamp	Vida Screw	Anahtar Allen Key
MWLNr ISO			H1	H	B	F	L1	L2	λS	Y0						
SİPARİŞ KODU - R Ordering Code - R	SİPARİŞ KODU - L Ordering Code - L															
D 7619	D 7605	✓	16	16	20	125	35	-6	-6	WNMG 0604	WNMG 06	5X3,6X15	M060105	M5X23	A3	
D 7620	D 7606	✓	20	20	25	125	35	-6	-6	WNMG 0604	WNMG 06	5X3,6X15	M060105	M5X23	A3	
D 7621	D 7607	✓	25	25	32	150	40	-6	-6	WNMG 0604	WNMG 06	5X3,6X15	M060105	M5X23	A3	
D 7622	D 7608	✓	20	20	25	125	35	-6	-6	WNMG 0804	WNMG 08	6X5X8	M080105	M6X27	A3	
D 7623	D 7609	✓	25	25	32	150	40	-6	-6	WNMG 0804	WNMG 08	6X5X8	M080105	M6X27	A3	
D 7624	D 7610	✓	32	32	40	170	40	-6	-6	WNMG 0804	WNMG 08	6X5X8	M080105	M6X27	A3	
D 7625	D 7611	✓	40	40	50	200	45	-6	-6	WNMG 0804	WNMG 08	6X5X8	M080105	M6X27	A3	

### MWDNN ISO



50°

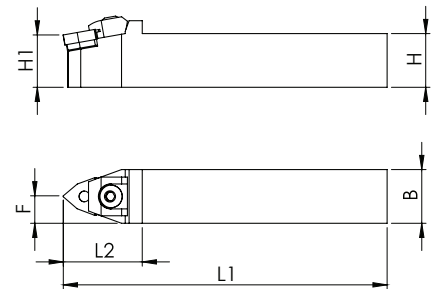

Kesici Uç Uyumluluğu Insert Suitability		Stok Stock	Takım Ölçüleri / Dimension (mm)								Uç Insert	Altlık Shim	Vida Screw	Pabuç Clamp	Vida Screw	Anahtar Allen Key
MWDNN ISO			H1	H	B	F	L1	L2	λS	Y0						
SİPARİŞ KODU Ordering Code																
D 7599		✓	16	16	8	125	35	-10	0	WNMG 0604	WNMG 06	5X3,6X15	M060105	M5X23	A3	
D 7600		✓	20	20	10	125	35	-10	0	WNMG 0604	WNMG 06	5X3,6X15	M060105	M5X23	A3	
D 7601		✓	20	20	10	125	40	-10	0	WNMG 0804	WNMG 08	6X5X8	M080105	M6X27	A3	
D 7602		✓	25	25	12,5	150	40	-10	0	WNMG 0804	WNMG 08	6X5X8	M080105	M6X27	A3	
D 7603		✓	32	32	16	170	40	-10	0	WNMG 0804	WNMG 08	6X5X8	M080105	M6X27	A3	
D 7604		✓	40	40	20	200	45	-10	0	WNMG 0804	WNMG 08	6X5X8	M080105	M6X27	A3	

### PCLNR ISO



95°

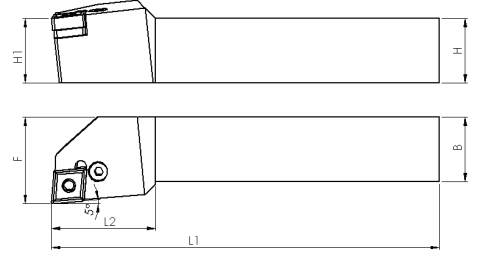

Kesici Uç Uyumluluğu Insert Suitability		Stok Stock	Takım Ölçüleri / Dimension (mm)							Uç Insert	Altık Shim	Vida Screw	Levye Crowbar	Altık Sacı Metal Sheet	Anahtar Allen Key
PCLNR ISO			H1	H	B	F	L1	L2	λS	Y0					
SİPARİŞ KODU - R Ordering Code - R	SİPARİŞ KODU - L Ordering Code - L														
D 7678	D 7676	✓	20	20	25	125	35	-6	-6	CNMG 1204	CNMG 12	MPV M8K	MPL 012	MPS 012	A3
D 7679	D 7677	✓	25	25	32	150	40	-6	-6	CNMG 1204	CNMG 12	MPV M8K	MPL 012	MPS 012	A3
D 7680	D 11298	✓	32	32	40	170	40	-6	-6	CNMG 1204	CNMG 12	MPV M8K	MPL 012	MPS 012	A3
D 7681	D 11322	✓	40	40	50	200	45	-6	-6	CNMG 1204	CNMG 12	MPV M8K	MPL 012	MPS 012	A3
D 7682	D 11522	✓	25	25	32	150	40	-6	-6	CNMG 1606	CNMG 16	MPV M8U	MPL 016	MPS 016	A4
D 7683	D 11487	✓	32	32	40	170	40	-6	-6	CNMG 1606	CNMG 16	MPV M8U	MPL 016	MPS 016	A4
D 7684	X	✓	40	40	50	200	45	-6	-6	CNMG 1606	CNMG 16	MPV M8U	MPL 016	MPS 016	A4
D 7685	D 11515	✓	32	32	40	170	40	-6	-6	CNMG 1906	CNMG 19	MPV M8U	MPL 019	MPS 019	A4
D 7686	X	✓	40	40	50	200	45	-6	-6	CNMG 1906	CNMG 19	MPV M8U	MPL 019	MPS 019	A4

### PDJNR ISO



93°

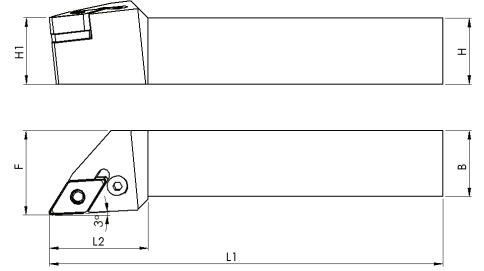

Kesici Uç Uyumluluğu Insert Suitability		Stok Stock	Takım Ölçüleri / Dimension (mm)							Uç Insert	Altık Shim	Vida Screw	Levye Crowbar	Altık Sacı Metal Sheet	Anahtar Allen Key
PDJNR ISO			H1	H	B	F	L1	L2	λS	Y0					
SİPARİŞ KODU - R Ordering Code - R	SİPARİŞ KODU - L Ordering Code - L														
D 7692	D 11499	✓	20	20	25	125	35	-6	-6	DNM. 1506	DNMG 15	MPV M8K	MPL 015	MPS 015	A3
D 7693	D 11500	✓	25	25	32	150	40	-6	-6	DNM. 1506	DNMG 15	MPV M8K	MPL 015	MPS 015	A3
D 7694	D 11501	✓	32	32	40	170	40	-6	-6	DNM. 1506	DNMG 15	MPV M8U	MPL 015	MPS 015	A4
D 7695	D 11502	✓	40	40	45	200	45	-6	-6	DNM. 1506	DNMG 15	MPV M8U	MPL 015	MPS 015	A4

### PDNNN ISO

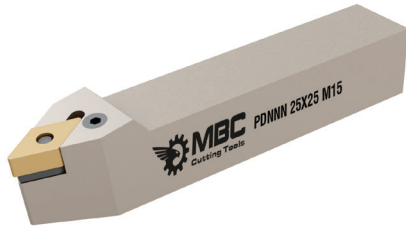

62,5°

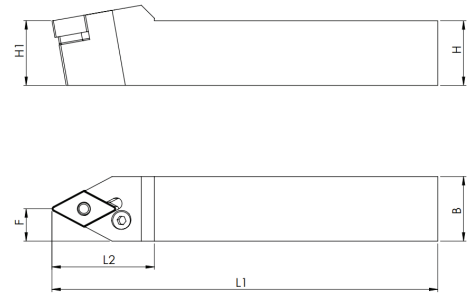

Kesici Uç Uyumluluğu Insert Suitability		Stok Stock	Takım Ölçüleri / Dimension (mm)							Uç Insert	Altık Shim	Vida Screw	Levye Crowbar	Altık Sacı Metal Sheet	Anahtar Allen Key
PDNNN ISO			H1	H	B	F	L1	L2	λS	Y0					
SİPARİŞ KODU Ordering Code															
D 11503		✓	20	20	25	125	35	-6	0	DNM. 1506	DNMG 15	MPV M8K	MPL 015	MPS 015	A3
D 11504		✓	25	25	32	150	40	-6	0	DNM. 1506	DNMG 15	MPV M8K	MPL 015	MPS 015	A3
D 11505		✓	32	32	40	170	40	-6	0	DNM. 1506	DNMG 15	MPV M8U	MPL 015	MPS 015	A4
D 11506		✓	40	40	45	200	45	-6	0	DNM. 1506	DNMG 15	MPV M8U	MPL 015	MPS 015	A4

**PSDNN ISO**

**NEW**

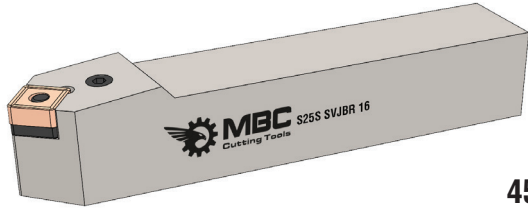

45°

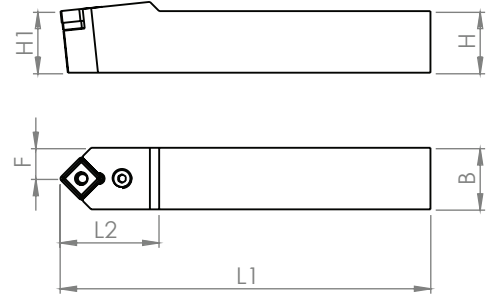

Kesici Uç Uyumluluğu Insert Suitability		Stok Stock	Takım Ölçüleri / Dimension (mm)								Uç Insert	Altlık Shim	Vida Screw	Levye Crowbar	Altlık Sacı Metal Sheet	Anahtar Allen Key
PSDNN ISO			H1	H	B	F	L1	L2	λS	Y0						
SİPARİŞ KODU - R Ordering Code - R	SİPARİŞ KODU - L Ordering Code - L															
D 12446	X	✓	20	20	25	125	35	-6	-6	DNM. 1506	DNMG 15	MPV M8K	MPL 015	MPL 015	A3	
D 21283	X	✓	25	25	32	150	40	-6	-6	DNM. 1506	DNMG 15	MPV M8K	MPL 015	MPL 015	A3	
D 21284	X	✓	32	32	40	170	40	-6	-6	DNM. 1506	DNMG 15	MPV M8U	MPL 015	MPL 015	A4	

**PWLNR ISO**

95°

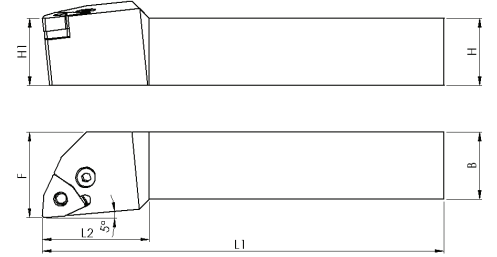

Kesici Uç Uyumluluğu Insert Suitability		Stok Stock	Takım Ölçüleri / Dimension (mm)								Uç Insert	Altlık Shim	Vida Screw	Levye Crowbar	Altlık Sacı Metal Sheet	Anahtar Allen Key
PWLNR ISO			H1	H	B	F	L1	L2	λS	Y0						
SİPARİŞ KODU - R Ordering Code - R	SİPARİŞ KODU - L Ordering Code - L															
D 11207	D 11275	✓	20	20	25	125	35	-6	-6	WNMG 0804	WNMG 08	MPV M8K	MPL 08	MPS 08	A3	
D 7762	D 7759	✓	25	25	32	150	40	-6	-6	WNMG 0804	WNMG 08	MPV M8K	MPL 08	MPS 08	A3	
D 7760	D 11297	✓	32	32	40	170	40	-6	-6	WNMG 0804	WNMG 08	MPV M8U	MPL 08	MPS 08	A4	
D 7761	D 11321	✓	40	40	50	200	45	-6	-6	WNMG 0804	WNMG 08	MPV M8U	MPL 08	MPS 08	A4	

**PTJNR ISO**

93°

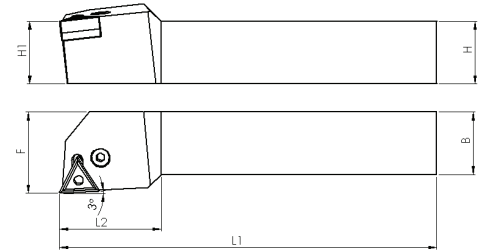

Kesici Uç Uyumluluğu Insert Suitability		Stok Stock	Takım Ölçüleri / Dimension (mm)								Uç Insert	Altlık Shim	Vida Screw	Levye Crowbar	Altlık Sacı Metal Sheet	Anahtar Allen Key
PTJNR ISO			H1	H	B	F	L1	L2	λS	Y0						
SİPARİŞ KODU - R Ordering Code - R	SİPARİŞ KODU - L Ordering Code - L															
D 17091	D 21203	✓	20	20	25	125	35	-6	-6	TNMG 1604	TNMG 16	MPV M8K	MPL 016	MPS 016	A3	
D 17092	D 21227	✓	25	25	32	150	40	-6	-6	TNMG 1604	TNMG 16	MPV M8K	MPL 016	MPS 016	A3	
D 7748	D 21226	✓	32	32	40	170	40	-6	-6	TNMG 1604	TNMG 16	MPV M8U	MPL 016	MPS 016	A4	
D 7749	D 11523	✓	25	25	32	150	40	-6	-6	TNMG 2204	TNMG 22	MPV M8K	MPL 022	MPS 022	A3	
D 7750	D 11563	✓	32	32	40	170	40	-6	-6	TNMG 2204	TNMG 22	MPV M8U	MPL 022	MPS 022	A4	
D 7751	X	✓	40	40	50	200	45	-6	-6	TNMG 2204	TNMG 22	MPV M8U	MPL 022	MPS 022	A4	



## S-SİSTEM İÇ ÇAP TORNALAMA KATERLERİ

S-SYSTEM INTERNAL TURNING TOOLHOLDERS

### SCLCR KBR

NEW



95°

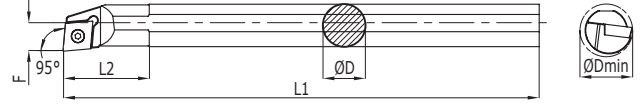

Kesici Uç Uyumluluğu Insert Suitability		Stok Stock	Takım Ölçüleri / Dimension (mm)							Uç Insert	Altık Shim	Vida Screw	Vida Screw	Anahtar Torx Key
KBR SCLCR			D	D min	F	L1	L2	ΛF	YP					
SİPARİŞ KODU - R Ordering Code - R	SİPARİŞ KODU - L Ordering Code - L													
S 16542	S 16554	✓	6	9	4,5	100	30	-10	0	CC.T 0402	-	-	M2X4	T06
S 16543	S 16555	✓	8	11	6	100	25	-10	0	CC.T 0602	-	-	M2,5X5	T08
S 16544	S 16568	✓	8	11	6	125	25	-10	0	CC.T 0602	-	-	M2,5X5	T08
S 16545	X	✓	10	13	7	125	25	-10	0	CC.T 0602	-	-	M2,5X5	T08
S 16549 (S)	S 16561 (S)	✓	10	13	7	125	25	-10	0	CC.T 0602	-	-	M2,5X5	T08
S 16546	S 16556	✓	12	16	9	125	30	-8	0	CC.T 0602	-	-	M2,5X5	T08
S 16550 (S)	S 16582 (S)	✓	12	16	9	125	30	-8	0	CC.T 0602	-	-	M2,5X5	T08
S 16569	X	✓	16	20	11	180	35	-8	0	CC.T 09T3	-	-	M3,5X8	T15
S 16589	S 16551	✓	18	20	11	180	35	-8	0	CC.T 09T3	-	-	M3,5X8	T15
S 16547	X	✓	20	25	13	150	40	-8	0	CC.T 09T3	-	-	M3,5X8	T15
S 16548	X	✓	20	25	13	180	40	-8	0	CC.T 09T3	-	-	M3,5X8	T15
S 16552 (S)	X	✓	20	25	13	180	40	-8	0	CC.T 09T3	-	-	M3,5X8	T15

### SDUCR KBR

NEW



93°

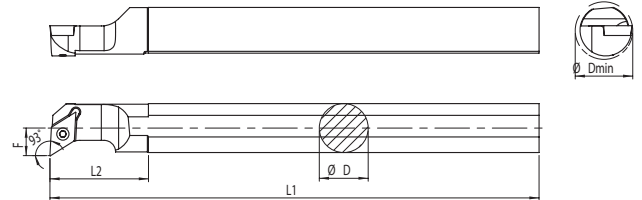

Kesici Uç Uyumluluğu Insert Suitability		Stok Stock	Takım Ölçüleri / Dimension (mm)							Uç Insert	Altık Shim	Vida Screw	Vida Screw	Anahtar Torx Key
KBR SDUCR			D	D min	F	L1	L2	ΛF	YP					
SİPARİŞ KODU - R Ordering Code - R	SİPARİŞ KODU - L Ordering Code - L													
S 16570	X	✓	10	13	7,5	125	25	-11	0	DC.T 0702	-	-	M2,5X5	T08
S 16571 (S)	S 16572 (S)	✓	10	13	7,5	125	25	-11	0	DC.T 0702	-	-	M2,5X5	T08
S 16573	S 16574	✓	12	16	9	125	30	-9	0	DC.T 0702	-	-	M2,5X5	T08
S 16575 (S)	S 16576 (S)	✓	12	16	9	125	30	-9	0	DC.T 0702	-	-	M2,5X5	T08
S 16577 (S)	X	✓	12	16	9	150	30	-9	0	DC.T 0702	-	-	M2,5X7	T08
S 16849 (S)	X	✓	16	20	11	125	35	-9	0	DC.T 11T3	-	-	M3,5X8	T15
S 16578 (S)	S 16579 (S)	✓	16	20	11	180	35	-9	0	DC.T 11T3	-	-	M3,5X8	T15
S 16850	X	✓	16	20	11	180	35	-9	0	DC.T 11T3	-	-	M3,5X8	T15
S 16580	X	✓	18	20	11	180	35	-9	0	DC.T 11T3	-	-	M3,5X8	T15
S 16581	X	✓	20	25	13	125	40	-8	0	DC.T 11T3	-	-	M3,5X8	T15
S 16848	X	✓	20	25	13	180	40	-8	0	DC.T 11T3	-	-	M3,5X8	T15
S 16539	X	✓	20	25	13	200	40	-8	0	DC.T 11T3	-	-	M3,5X8	T15

### SVUBR ISO



93°

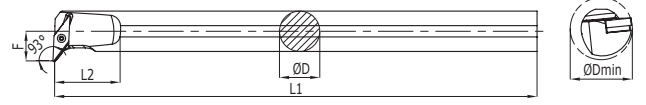

Kesici Uç Uyumluluğu Insert Suitability		Stok Stock	Takım Ölçüleri / Dimension (mm)							Uç Insert	Altık Shim	Vida Screw	Vida Screw	Anahtar Torx Key
SVUBR ISO			D	D min	F	L1	L2	λF	YP					
SİPARİŞ KODU - R Ordering Code - R	SİPARİŞ KODU - L Ordering Code - L													
S 9519	S 9514	✓	16	20	11	180	40	-8	0	VBM. 1103	-	-	M2,5X7	T08
S 9520	S 9515	✓	20	25	13	200	40	-8	0	VBM. 1103	-	-	M2,5X7	T08
S 9521	S 9516	✓	25	32	17	250	50	-9	0	VBM. 1604	VBMT 16	M5X0,5X3,5	M3,5X11	T15
S 9522	S 9517	✓	32	40	22	300	60	-9	0	VBM. 1604	VBMT 16	M5X0,5X3,5	M3,5X11	T15
S 9523	S 9518	✓	40	50	27	400	70	-9	0	VBM. 1604	VBMT 16	M5X0,5X3,5	M3,5X11	T15

### SVUCR ISO



93°

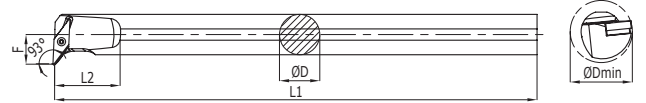

Kesici Uç Uyumluluğu Insert Suitability		Stok Stock	Takım Ölçüleri / Dimension (mm)							Uç Insert	Altık Shim	Vida Screw	Vida Screw	Anahtar Torx Key
SVUCR ISO			D	D min	F	L1	L2	λF	YP					
SİPARİŞ KODU - R Ordering Code - R	SİPARİŞ KODU - L Ordering Code - L													
S 9529	S 9524	✓	16	20	11	180	40	-8	0	VCM. 1103	-	-	M2,5X7	T08
S 9530	S 9525	✓	20	25	13	200	40	-8	0	VCM. 1103	-	-	M2,5X7	T08
S 9531	S 9526	✓	25	32	17	250	50	-9	0	VCM. 1604	VCMT 16	M5X0,5X3,5	M3,5X11	T15
S 9532	S 9527	✓	32	40	22	300	60	-9	0	VCM. 1604	VCMT 16	M5X0,5X3,5	M3,5X11	T15
S 9533	S 9528	✓	40	50	27	400	70	-9	0	VCM. 1604	VCMT 16	M5X0,5X3,5	M3,5X11	T15

### SVJBR ISO



93°

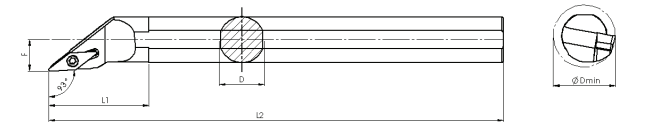

Kesici Uç Uyumluluğu Insert Suitability		Stok Stock	Takım Ölçüleri / Dimension (mm)							Uç Insert	Altık Shim	Vida Screw	Vida Screw	Anahtar Torx Key
SVJBR ISO			D	D min	F	L1	L2	λF	YP					
SİPARİŞ KODU - R Ordering Code - R	SİPARİŞ KODU - L Ordering Code - L													
S 9497	S 12494	✓	25	32	17	250	50	-	-	VBM. 1604	VBMT 16	M5X0,5X3,5	M3,5X11	T15
S 9498	S 12448	✓	32	40	23	300	60	-	-	VBM. 1604	VBMT 16	M5X0,5X3,5	M3,5X11	T15
S 9499	X	✓	40	50	27	400	80	-	-	VBM. 1604	VBMT 16	M5X0,5X3,5	M3,5X11	T15

# S-SİSTEM İÇ ÇAP TORNALAMA KATERLERİ

## S-SYSTEM INTERNAL TURNING TOOLHOLDERS

### SV-BR ISO

NEW



72,5°

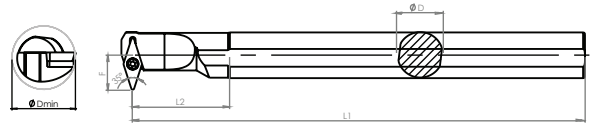

Kesici Uç Uyumluluğu Insert Suitability		Stok Stock	Takım Ölçüleri / Dimension (mm)							Uç Insert	Altık Shim	Vida Screw	Vida Screw	Anahtar Torx Key
SV-BR ISO			D	D min	F	L1	L2	λF	YP					
SIPARIŞ KODU - R Ordering Code - R	SIPARIŞ KODU - L Ordering Code - L													
S 17018	S 21276	✓	25	32	17	250	50	-	-	VBM. 1604	VBMT 16	M5X0,5X11	M3,5X14	T15
S 21277	S 21278	✓	32	40	23	300	60	-	-	VBM. 1604	VBMT 16	M5X0,5X11	M3,5X14	T15
S 21279	S 21280	✓	40	50	27	400	80	-	-	VBM. 1604	VBMT 16	M5X0,5X11	M3,5X14	T15

### SDPCR ISO



97,5°

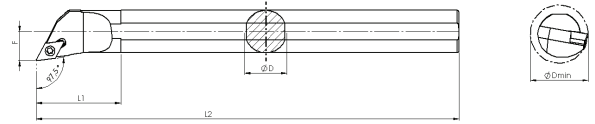

Kesici Uç Uyumluluğu Insert Suitability		Stok Stock	Takım Ölçüleri / Dimension (mm)							Uç Insert	Altık Shim	Vida Screw	Vida Screw	Anahtar Torx Key
SDPCR ISO			D	D min	F	L1	L2	λF	YP					
SIPARIŞ KODU - R Ordering Code - R	SIPARIŞ KODU - L Ordering Code - L													
S 7903	S 14259	✓	10	13	7,5	125	25	-	-	DC.T 0702	-	-	M2,5X5	T08
S 7904	S 14260	✓	12	16	9	150	30	-	-	DC.T 0702	-	-	M2,5X5	T08
S 11221	S 14261	✓	16	20	11	180	35	-	-	DC.T 11T3	-	-	M3,5X8	T15
S 7905	S 14262	✓	20	25	13	200	40	-	-	DC.T 11T3	-	-	M3,5X8	T15
S 7906	S 14140	✓	25	32	17,5	250	50	-	-	DC.T 11T3	DCMT 11	M5X0,5X3,5	M3,5X14	T15
S 7907	S 14263	✓	32	40	23	300	60	-	-	DC.T 11T3	DCMT 11	M5X0,5X3,5	M3,5X14	T15
S 16775	X	✓	40	50	27	400	80	-	-	DC.T 11T3	DCMT 11	M5X0,5X3,5	M3,5X14	T15

### SDUCR ISO



93°

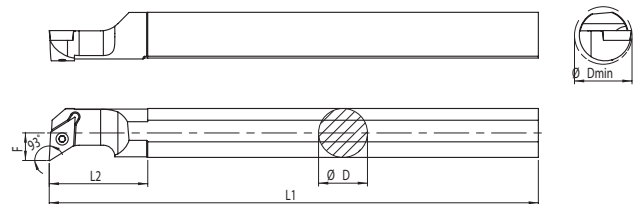

Kesici Uç Uyumluluğu Insert Suitability		Stok Stock	Takım Ölçüleri / Dimension (mm)							Uç Insert	Altık Shim	Vida Screw	Vida Screw	Anahtar Torx Key
SDUCR ISO			D	D min	F	L1	L2	λF	YP					
SIPARIŞ KODU - R Ordering Code - R	SIPARIŞ KODU - L Ordering Code - L													
S 7942	S 7930	✓	10	13	7,5	125	25	-11	0	DC.T 0702	-	-	M2,5X5	T08
S 7943 (S)	S 11232 (S)	✓	10	13	7,5	125	25	-11	0	DC.T 0702	-	-	M2,5X5	T08
S 7944	S 7931	✓	12	16	9	150	30	-9	0	DC.T 0702	-	-	M2,5X5	T08
S 7945 (S)	S 7932 (S)	✓	12	16	9	150	30	-9	0	DC.T 0702	-	-	M2,5X5	T08
S 7946	S 7933	✓	16	20	11	180	35	-9	0	DC.T 0702	-	-	M2,5X7	T08
S 7947	S 7934	✓	16	20	11	180	35	-9	0	DC.T 11T3	-	-	M3,5X8	T15
S 7948 (S)	S 7935 (S)	✓	16	20	11	180	35	-9	0	DC.T 11T3	-	-	M3,5X8	T15
S 7949	S 7936	✓	20	25	13	200	40	-8	0	DC.T 0702	-	-	M2,5X7	T08
S 7950	S 7937	✓	20	25	13	200	40	-8	0	DC.T 11T3	-	-	M3,5X10	T15
S 7951 (S)	S 12556 (S)	✓	20	25	13	200	40	-8	0	DC.T 11T3	-	-	M3,5X10	T15
S 7952	S 7938	✓	25	32	17,5	250	50	-8	0	DC.T 11T3	DCMT 11	M5X0,5X3,5	M3,5X14	T15
S 7953 (S)	S 12557 (S)	✓	25	32	17,5	250	50	-8	0	DC.T 11T3	DCMT 11	M5X0,5X3,5	M3,5X14	T15
S 7954	S 7939	✓	25	32	17,5	250	50	-8	0	DC.T 0702	-	-	M2,5X7	T08
S 7955	S 7940	✓	32	40	23	300	60	-8	0	DC.T 11T3	DCMT 11	M5X0,5X3,5	M3,5X14	T15
S 7956	S 7941	✓	40	50	27	400	60	-8	0	DC.T 11T3	DCMT 11	M5X0,5X3,5	M3,5X14	T15

**SDQCR ISO**



107,5°

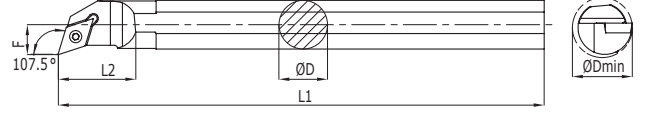

Kesici Uç Uyumluluğu Insert Suitability		Stok Stock	Takım Ölçüleri / Dimension (mm)								Uç Insert	Altık Shim	Vida Screw	Vida Screw	Anahtar Torx Key
SIPARIŞ KODU - R Ordering Code - R	SIPARIŞ KODU - L Ordering Code - L		D	D min	F	L1	L2	λF	YP						
<b>S 7917</b>	<b>S 7908</b>	✓	10	13	7,5	125	25	-11	0	DC.T 0702	-	-	M2,5X5	T08	
<b>S 7918 (S)</b>	X	✓	10	12	7,5	125	25	-11	0	DC.T 0702	-	-	M2,5X5	T08	
<b>S 7919</b>	<b>S 7909</b>	✓	12	16	9	150	30	-9	0	DC.T 0702	-	-	M2,5X5	T08	
<b>S 7920 (S)</b>	X	✓	12	16	9	150	30	-9	0	DC.T 0702	-	-	M2,5X5	T08	
<b>S 7921</b>	<b>S 7910</b>	✓	16	20	11	180	35	-9	0	DC.T 0702	-	-	M2,5X7	T08	
<b>S 7922</b>	<b>S 7911</b>	✓	20	25	13	200	40	-8	0	DC.T 0702	-	-	M2,5X7	T08	
<b>S 7923</b>	<b>S 7912</b>	✓	16	20	11	180	35	-9	0	DC.T 11T3	-	-	M3,5X8	T15	
<b>S 7924 (S)</b>	X	✓	16	20	11	180	35	-9	0	DC.T 11T3	-	-	M3,5X8	T15	
<b>S 7925</b>	<b>S 7913</b>	✓	20	25	13	200	40	-8	0	DC.T 11T3	-	-	M3,5X10	T15	
<b>S 7926 (S)</b>	X	✓	20	25	13	200	40	-8	0	DC.T 11T3	-	-	M3,5X10	T15	
<b>S 7927</b>	<b>S 7914</b>	✓	25	32	17,5	250	50	-8	0	DC.T 0702	-	-	M2,5X7	T08	
<b>S 7928</b>	<b>S 7915</b>	✓	25	32	17,5	250	50	-8	0	DC.T 11T3	DCMT 11	M5X0,5X3,5	M3,5X14	T15	
<b>S 7929</b>	<b>S 7916</b>	✓	32	40	23	300	60	-8	0	DC.T 11T3	DCMT 11	M5X0,5X3,5	M3,5X14	T15	
<b>S 12420</b>	<b>S 12421</b>	✓	40	50	27	400	80	-	-	DC.T 11T3	DCMT 11	M5X0,5X3,5	M3,5X14	T15	

**SD-CR ISO**



62,5°

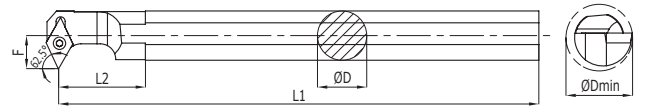

Kesici Uç Uyumluluğu Insert Suitability		Stok Stock	Takım Ölçüleri / Dimension (mm)								Uç Insert	Altık Shim	Vida Screw	Vida Screw	Anahtar Torx Key
SIPARIŞ KODU - R Ordering Code - R	SIPARIŞ KODU - L Ordering Code - L		D	D min	F	L1	L2	λF	YP						
<b>S 7867</b>	<b>S 7859</b>	✓	10	14	8,5	125	28	-9	0	DC.T 0702	-	-	M2,5X5	T08	
<b>S 7868</b>	<b>S 7860</b>	✓	12	16	9	150	30	-9	0	DC.T 0702	-	-	M2,5X5	T08	
<b>S 7869</b>	<b>S 7861</b>	✓	16	23	14	180	40	-8	0	DC.T 0702	-	-	M2,5X7	T08	
<b>S 7870</b>	<b>S 7862</b>	✓	16	23	14	180	40	-8	0	DC.T 11T3	-	-	M3,5X8	T15	
<b>S 7871</b>	<b>S 7863</b>	✓	20	25	14,5	200	45	-8	0	DC.T 11T3	-	-	M3,5X10	T15	
<b>S 7872</b>	<b>S 7864</b>	✓	25	32	19	250	55	-8	0	DC.T 11T3	DCMT 11	M5X0,5X3,5	M3,5X14	T15	
<b>S 7873</b>	<b>S 7865</b>	✓	32	40	23	300	60	-12	0	DC.T 11T3	DCMT 11	M5X0,5X3,5	M3,5X14	T15	
<b>S 7874</b>	<b>S 7866</b>	✓	40	50	27	400	70	-10	0	DC.T 11T3	DCMT 11	M5X0,5X3,5	M3,5X14	T15	

### SDXCR ISO



93°

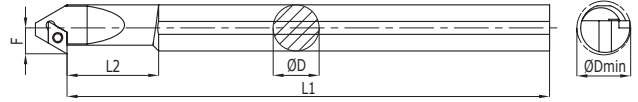

Kesici Uç Uyumluluğu Insert Suitability		Stok Stock	Takım Ölçüleri / Dimension (mm)								Uç Insert	Altılık Shim	Vida Screw	Vida Screw	Anahtar Torx Key
SDXCR ISO			D	D min	F	L1	L2	λF	YP						
SIPARIŞ KODU - R Ordering Code - R	SIPARIŞ KODU - L Ordering Code - L														
S 7964	S 7957	✓	12	16	9	150	30	-7	0	DC.T 0702	-	-	M2,5X5	T08	
S 7965	S 7958	✓	16	22	12,5	180	40	-9	0	DC.T 0702	-	-	M2,5X7	T08	
S 7966	S 7959	✓	16	22	12,5	180	40	-9	0	DC.T 11T3	-	-	M3,5X8	T15	
S 7967	S 7960	✓	20	25	14	200	55	-9	0	DC.T 11T3	-	-	M3,5X10	T15	
S 7968	S 7961	✓	25	32	17,5	250	65	-10	0	DC.T 11T3	DCMT 11	M5X0,5X3,5	M3,5X14	T15	
S 7969	S 7962	✓	32	40	23	300	80	-13	0	DC.T 11T3	DCMT 11	M5X0,5X3,5	M3,5X14	T15	
S 7970	S 7963	✓	40	50	27	400	80	-13	0	DC.T 11T3	DCMT 11	M5X0,5X3,5	M3,5X14	T15	

### SET SDUCR ISO

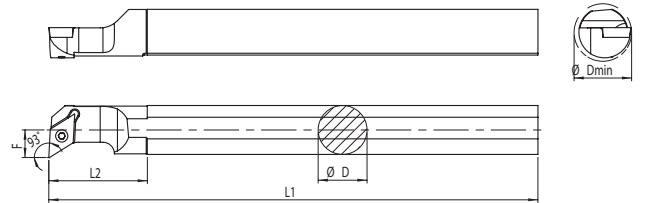

Kesici Uç Uyumluluğu Insert Suitability		Stok Stock	Takım Ölçüleri / Dimension (mm)								Uç Insert	Altılık Shim	Vida Screw	Vida Screw	Anahtar Torx Key
SET SDUCR ISO			D	D min	F	L1	L2	λF	YP						
SIPARIŞ KODU - R Ordering Code - R	SIPARIŞ KODU - L Ordering Code - L														
S 14282	S 14283	✓	10	13	7,5	125	25	-11	0	DC.T 0702	-	-	M2,5X5	T08	
		✓	12	16	9	150	30	-9	0	DC.T 0702	-	-	M2,5X5	T08	
		✓	16	20	11	180	35	-9	0	DC.T 11T3	DCMT 11	M5X5,5X3,5	M3X8	T15	
S 14285	S 14284	✓	10	13	7,5	125	25	-11	0	DC.T 0702	-	-	M2,5X5	T08	
		✓	12	16	9	150	30	-9	0	DC.T 0702	-	-	M2,5X5	T08	
		✓	16	20	11	180	35	-9	0	DC.T 11T3	DCMT 11	M5X5,5X3,5	M3X8	T15	
		✓	20	25	13	200	40	-8	0	DC.T 11T3	DCMT 11	M5X5,5X3,5	M3X8	T15	

### SET SCLCR ISO

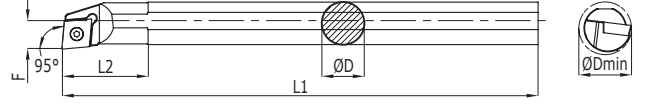

Kesici Uç Uyumluluğu Insert Suitability		Stok Stock	Takım Ölçüleri / Dimension (mm)						Uç Insert	Altlık Shim	Vida Screw	Vida Screw	Anahtar Torx Key	
SET SCLCR ISO			D	D min	F	L1	L2	λF	YP					
SİPARİŞ KODU - R Ordering Code - R	SİPARİŞ KODU - L Ordering Code - L													
S 7999	S 12575	✓	8	10	6	100	30	-10	0	CC.T 0602	-	-	M2,5X5	T08
		✓	10	13	7	125	25	-10	0	CC.T 0602	-	-	M2,5X5	T08
		✓	12	16	9	150	30	-8	0	CC.T 0602	-	-	M2,5X5	T08
		✓	16	20	11	180	35	-8	0	CC.T 09T3	-	-	M3,5X8	T15
S 14287	S 14286	✓	8	10	6	100	30	-10	0	CC.T 0602	-	-	M2,5X5	T08
		✓	10	13	7	125	25	-10	0	CC.T 0602	-	-	M2,5X5	T08
		✓	12	16	9	150	30	-8	0	CC.T 0602	-	-	M2,5X5	T08
		✓	16	20	11	180	35	-8	0	CC.T 09T3	-	-	M3,5X8	T15
		✓	20	25	13	200	40	-8	0	CC.T 09T3	-	-	M3,5X11	T15
S 8003	S 8001	✓	6	9	4,5	100	30	-10	0	CC.T 0602	-	-	M2,5X5	T08
		✓	8	10	6	100	30	-10	0	CC.T 0602	-	-	M2,5X5	T08
		✓	10	13	7	125	25	-10	0	CC.T 0602	-	-	M2,5X5	T08
		✓	12	16	9	150	30	-8	0	CC.T 0602	-	-	M2,5X5	T08
		✓	16	20	11	180	35	-8	0	CC.T 09T3	-	-	M3,5X8	T15
		✓	20	25	13	200	40	-8	0	CC.T 09T3	-	-	M3,5X11	T15

### SET SDUCR ISO (S) INTER COOLAND

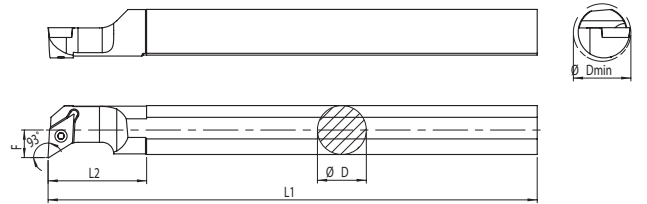

Kesici Uç Uyumluluğu Insert Suitability		Stok Stock	Takım Ölçüleri / Dimension (mm)						Uç Insert	Altlık Shim	Vida Screw	Vida Screw	Anahtar Torx Key	
SET SDUCR ISO (S) INTER COOLAND			D	D min	F	L1	L2	λF	YP					
SİPARİŞ KODU - R Ordering Code - R	SİPARİŞ KODU - L Ordering Code - L													
S 7998 (S)	S 7997 (S)	✓	10	13	7,5	125	25	-11	0	DC.T 0702	-	-	M2,5X5	T08
		✓	12	16	9	150	30	-9	0	DC.T 0702	-	-	M2,5X5	T08
		✓	16	20	11	180	35	-9	0	DC.T 11T3	DCMT 11	M5X5,5X3,5	M3X8	T15
S 12573 (S)	S 12574 (S)	✓	10	13	7,5	125	25	-11	0	DC.T 0702	-	-	M2,5X5	T08
		✓	12	16	9	150	30	-9	0	DC.T 0702	-	-	M2,5X5	T08
		✓	16	20	11	180	35	-9	0	DC.T 11T3	DCMT 11	M5X5,5X3,5	M3X8	T15
		✓	20	25	13	200	40	-8	0	DC.T 11T3	DCMT 11	M5X5,5X3,5	M3X8	T15

SET SCLCR ISO (S) INTER COOLAND

NEW

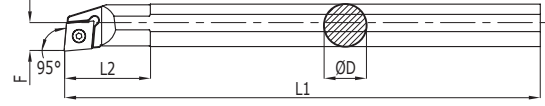

Kesici Uç Uyumluluğu Insert Suitability		Stok Stock	Takım Ölçüleri / Dimension (mm)						Uç Insert	Altlık Shim	Vida Screw	Vida Screw	Anahtar Torx Key	
SIPARIŞ KODU - R Ordering Code - R	SIPARIŞ KODU - L Ordering Code - L		D	D min	F	L1	L2	λF	YP					
S 16541 (S)	S 16540 (S)	✓	8	10	6	100	30	-10	0	CC.T 0602	-	-	M2,5X5	T08
		✓	10	13	7	125	25	-10	0	CC.T 0602	-	-	M2,5X5	T08
		✓	12	16	9	150	30	-8	0	CC.T 0602	-	-	M2,5X5	T08
		✓	16	20	11	180	35	-8	0	CC.T 09T3	-	-	M3,5X8	T15
S 8000 (S)	S 12576 (S)	✓	8	10	6	100	30	-10	0	CC.T 0602	-	-	M2,5X5	T08
		✓	10	13	7	125	25	-10	0	CC.T 0602	-	-	M2,5X5	T08
		✓	12	16	9	150	30	-8	0	CC.T 0602	-	-	M2,5X5	T08
		✓	16	20	11	180	35	-8	0	CC.T 09T3	-	-	M3,5X8	T15
		✓	20	25	13	200	40	-8	0	CC.T 09T3	-	-	M3,5X11	T15
S 8004 (S)	S 8002 (S)	✓	6	9	4,5	100	30	-10	0	CC.T 0602	-	-	M2,5X5	T08
		✓	8	10	6	100	30	-10	0	CC.T 0602	-	-	M2,5X5	T08
		✓	10	13	7	125	25	-10	0	CC.T 0602	-	-	M2,5X5	T08
		✓	12	16	9	150	30	-8	0	CC.T 0602	-	-	M2,5X5	T08
		✓	16	20	11	180	35	-8	0	CC.T 09T3	-	-	M3,5X8	T15
		✓	20	25	13	200	40	-8	0	CC.T 09T3	-	-	M3,5X11	T15



### SCLCR ISO

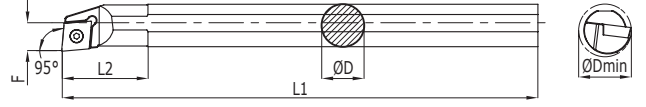

Kesici Uç Uyumluluğu Insert Suitability		Stok Stock	Takım Ölçüleri / Dimension (mm)								Uç İnsert	Altık Shim	Vida Screw	Vida Screw	Anahtar Torx Key
SCLCR			D	D min	F	L1	L2	λF	YP						
SİPARİŞ KODU - R Ordering Code - R	SİPARİŞ KODU - L Ordering Code - L														
S 7824	S 7792	✓	8	9	4,5	100	30	-10	0	CC.T 0602	-	-	M2,5X5	T08	
S 7825 (S)	S 7793 (S)	✓	8	9	4,5	100	30	-10	0	CC.T 0602	-	-	M2,5X5	T08	
S 7826	S 7794	✓	8	11	6	100	25	-10	0	CC.T 0602	-	-	M2,5X5	T08	
S 7827 (S)	S 7795 (S)	✓	8	11	6	100	25	-10	0	CC.T 0602	-	-	M2,5X5	T08	
S 7828	S 7796	✓	10	13	7	125	25	-10	0	CC.T 0602	-	-	M2,5X5	T08	
S 7829 (S)	S 7797 (S)	✓	10	13	7	125	25	-10	0	CC.T 0602	-	-	M2,5X5	T08	
S 12966	S 12967	✓	12	12,5	7	125	25	-10	0	CC.T 0602	-	-	M2,5X5	T08	
S 7830	S 7798	✓	12	16	9	150	30	-8	0	CC.T 0602	-	-	M2,5X5	T08	
S 7831 (S)	S 7799 (S)	✓	12	16	9	150	30	-8	0	CC.T 0602	-	-	M2,5X5	T08	
S 7832	S 7800	✓	12	16	9	150	30	-8	0	CC.T 09T3	-	-	M3,5X8	T15	
S 7833 (S)	S 12517 (S)	✓	12	16	9	150	30	-8	0	CC.T 09T3	-	-	M3,5X8	T15	
S 12968	X	✓	16	15,5	9	150	30	-8	0	CC.T 0602	-	-	M2,5X5	T08	
S 12969	S 14185	✓	16	15,5	9	150	30	-8	0	CC.T 09T3	-	-	M3,5X8	T15	
S 7834	S 7801	✓	16	20	11	180	35	-8	0	CC.T 0602	-	-	M2,5X5	T08	
S 7835 (S)	S 12518 (S)	✓	16	20	11	180	35	-8	0	CC.T 0602	-	-	M2,5X5	T08	
S 7836	S 7802	✓	16	20	11	180	35	-8	0	CC.T 09T3	-	-	M3,5X8	T15	
S 7837 (S)	S 7803 (S)	✓	16	20	11	180	35	-8	0	CC.T 09T3	-	-	M3,5X8	T15	
S 7838	S 7804	✓	20	25	13	200	40	-8	0	CC.T 09T3	-	-	M3,5X11	T15	
S 7839 (S)	S 7805 (S)	✓	20	25	13	200	40	-8	0	CC.T 09T3	-	-	M3,5X11	T15	
S 7840	S 7806	✓	25	32	17	250	50	-8	0	CC.T 09T3	-	-	M3,5X11	T15	
S 7843	S 7808	✓	25	32	17	250	50	-8	0	CC.T 1204	CCMT 12	M6X0,75X4	M4X11	T15	
S 7842 (S)	X	✓	25	32	17	250	50	-8	0	CC.T 1204	CCMT 12	M6X0,75X4	M4X11	T15	
S 7841	S 7807	✓	32	40	23	300	60	-8	0	CC.T 09T3	-	-	M3,5X11	T15	
S 16911	X	✓	40	50	27	400	70	-8	0	CC.T 1204	CCMT 12	M6X0,75X4	M4X11	T15	
S 7844	S 7809	✓	32	40	23	300	60	-8	0	CC.T 1204	CCMT 12	M6X0,75X4	M4X11	T15	
S 7845	S 7810	✓	40	50	27	400	70	-8	0	CC.T 1204	CCMT 12	M6X0,75X4	M4X11	T15	

**STFCR ISO**



90°

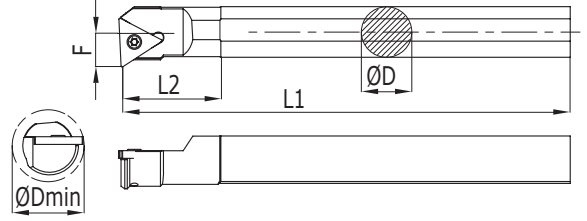

Kesici Uç Uyumluluğu Insert Suitability		Stok Stock	Takım Ölçüleri / Dimension (mm)							Uç Insert	Altlık Shim	Vida Screw	Vida Screw	Anahtar Torx Key
STFCR ISO			D	D min	F	L1	L2	ΛF	YP					
SIPARIŞ KODU - R Ordering Code - R	SIPARIŞ KODU - L Ordering Code - L													
S 12409	X	✓	12	15,5	9	150	30	-9	0	TC.T 11..	-	-	M2,5X6	T08
S 9461	S 9451	✓	16	20	11	180	35	-9	0	TC.T 16T3	-	-	M3,5X8	T15
S 9462	S 9452	✓	20	25	13	200	40	-8	0	TC.T 16T3	TCMT 16	M5X0,5X3,5	M3,5X11	T15
S 9463	S 9453	✓	25	32	17,5	250	50	-8	0	TC.T 16T3	TCMT 16	M5X0,5X3,5	M3,5X11	T15
S 9464	S 9454	✓	32	40	23	300	60	-8	0	TC.T 16T3	TCMT 16	M5X0,5X3,5	M3,5X11	T15

**SCACR 06 ISO**

NEW

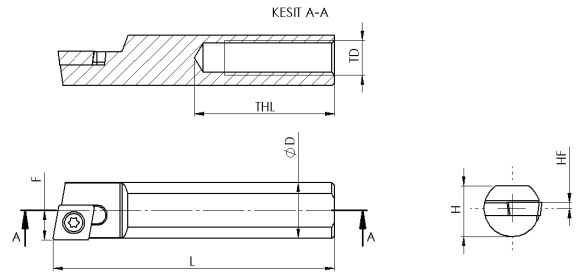
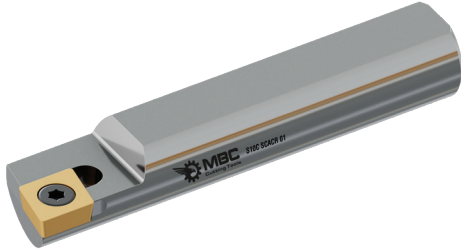

Kesici Uç Uyumluluğu Insert Suitability		Stok Stock	Takım Ölçüleri / Dimension (mm)							Uç Insert	Altlık Shim	Vida Screw	Vida Screw	Anahtar Torx Key
SCACR 06 ISO			D	H	L	HF	F	THL	TD					
SIPARIŞ KODU - R Ordering Code - R	SIPARIŞ KODU - L Ordering Code - L													
S 16912	S 16913	✓	10	9	40	1	5,3	25	M5X08	CC.T 0602	-	-	M2,5X5	T08
S 15424	S 7780	✓	10	9	50	1	5,3	25	M5X08	CC.T 0602	-	-	M2,5X5	T08
S 16914	S 16915	✓	10	9	60	1	5,3	25	M5X08	CC.T 0602	-	-	M2,5X5	T08
S 16916	S 16917	✓	10	9	70	1	5,3	30	M5X08	CC.T 0602	-	-	M2,5X5	T08
S 16918	S 16919	✓	10	9	80	1	5,3	30	M5X08	CC.T 0602	-	-	M2,5X5	T08
S 16920	S 16921	✓	12	11	40	1	6,3	25	M5X08	CC.T 0602	-	-	M2,5X5	T08
S 15426	S 15425	✓	12	11	50	1	6,3	25	M5X08	CC.T 0602	-	-	M2,5X5	T08
S 16922	S 16923	✓	12	11	60	1	6,3	25	M5X08	CC.T 0602	-	-	M2,5X5	T08
S 16924	S 16925	✓	12	11	70	1	6,3	30	M5X08	CC.T 0602	-	-	M2,5X5	T08
S 16926	S 16927	✓	12	11	80	1	6,3	30	M5X08	CC.T 0602	-	-	M2,5X5	T08
S 16928	S 16929	✓	16	15	40	1	8,5	25	M6X1	CC.T 0602	-	-	M2,5X5	T08
S 16930	S 16931	✓	16	15	50	1	8,5	25	M6X1	CC.T 0602	-	-	M2,5X5	T08
S 16932	S 16933	✓	16	15	60	1	8,5	25	M6X1	CC.T 0602	-	-	M2,5X5	T08
S 16934	S 16935	✓	16	15	70	1	8,5	30	M6X1	CC.T 0602	-	-	M2,5X5	T08
S 16936	S 16937	✓	16	15	80	1	8,5	30	M6X1	CC.T 0602	-	-	M2,5X5	T08

**SCACR 09 ISO**

**NEW**

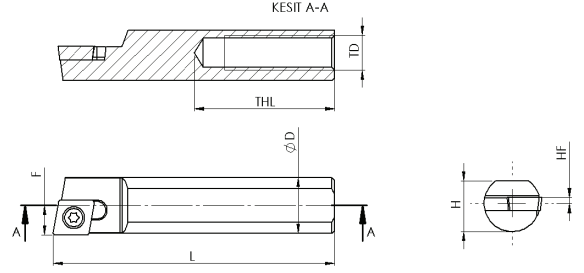

Kesici Uç Uyumluluğu Insert Suitability		Stok Stock	Takım Ölçüleri / Dimension (mm)							Uç Insert	Altlık Shim	Vida Screw	Vida Screw	Anahtar Torx Key
SCACR 09 ISO			D	H	L	HF	F	THL	TD					
SİPARİŞ KODU - R Ordering Code - R	SİPARİŞ KODU - L Ordering Code - L													
S 16948	S 16949	✓	12	11	40	2	6,3	25	M5X8	CC.T 09T3	-	-	M3,5X11	T15
S 16950	S 16951	✓	12	11	50	2	6,3	25	M5X8	CC.T 09T3	-	-	M3,5X11	T15
S 16952	S 16953	✓	12	11	60	2	6,3	25	M5X8	CC.T 09T3	-	-	M3,5X11	T15
S 16954	S 16955	✓	12	11	70	2	6,3	30	M5X8	CC.T 09T3	-	-	M3,5X11	T15
S 16956	S 16859	✓	12	11	80	2	6,3	30	M5X8	CC.T 09T3	-	-	M3,5X11	T15
S 16957	S 16958	✓	16	15	40	2	8,5	25	M6X1	CC.T 09T3	-	-	M3,5X11	T15
S 16959	S 16960	✓	16	15	50	2	8,5	25	M6X1	CC.T 09T3	-	-	M3,5X11	T15
S 16961	S 16962	✓	16	15	60	2	8,5	25	M6X1	CC.T 09T3	-	-	M3,5X11	T15
S 16963	S 16964	✓	16	15	70	2	8,5	30	M6X1	CC.T 09T3	-	-	M3,5X11	T15
S 16965	S 16860	✓	16	15	80	2	8,5	30	M6X1	CC.T 09T3	-	-	M3,5X11	T15

**SCMCN 06 ISO**

**NEW**

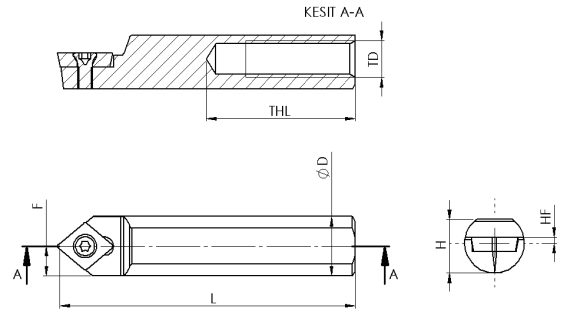
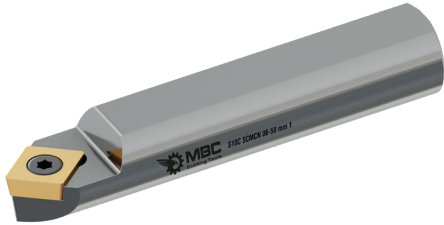

Kesici Uç Uyumluluğu Insert Suitability		Stok Stock	Takım Ölçüleri / Dimension (mm)							Uç Insert	Altlık Shim	Vida Screw	Vida Screw	Anahtar Torx Key
SCMCN 06 ISO			D	H	L	HF	F	THL	TD					
SİPARİŞ KODU Ordering Code														
S 15427		✓	8	7	40	1	4	25	M4X07	CC.T 0602	-	-	M2,5X5	T08
S 16966		✓	8	7	50	1	4	25	M4X07	CC.T 0602	-	-	M2,5X5	T08
S 16967		✓	8	7	60	1	4	25	M4X07	CC.T 0602	-	-	M2,5X5	T08
S 16968		✓	8	7	70	1	4	30	M4X07	CC.T 0602	-	-	M2,5X5	T08
S 16969		✓	8	7	80	1	4	30	M4X07	CC.T 0602	-	-	M2,5X5	T08
S 16970		✓	10	9	40	1	5	25	M5X08	CC.T 0602	-	-	M2,5X5	T08
S 15428		✓	10	9	50	1	5	25	M5X08	CC.T 0602	-	-	M2,5X5	T08
S 16971		✓	10	9	60	1	5	25	M5X08	CC.T 0602	-	-	M2,5X5	T08
S 16972		✓	10	9	70	1	5	30	M5X08	CC.T 0602	-	-	M2,5X5	T08
S 16856		✓	10	9	80	1	5	30	M5X08	CC.T 0602	-	-	M2,5X5	T08
S 16973		✓	12	11	40	1	6	25	M5X08	CC.T 0602	-	-	M2,5X5	T08
S 16974		✓	12	11	50	1	6	25	M5X08	CC.T 0602	-	-	M2,5X5	T08
S 15429		✓	12	11	60	1	6	25	M5X08	CC.T 0602	-	-	M2,5X5	T08
S 16975		✓	12	11	70	1	6	30	M5X08	CC.T 0602	-	-	M2,5X5	T08
S 16984		✓	12	11	80	1	6	30	M5X08	CC.T 0602	-	-	M2,5X5	T08
S 16976		✓	16	15	40	1	8	25	M6X1	CC.T 0602	-	-	M2,5X5	T08
S 16977		✓	16	15	50	1	8	25	M6X1	CC.T 0602	-	-	M2,5X5	T08
S 16978		✓	16	15	60	1	8	25	M6X1	CC.T 0602	-	-	M2,5X5	T08
S 16979		✓	16	15	70	1	8	30	M6X1	CC.T 0602	-	-	M2,5X5	T08
S 16989		✓	16	15	80	1	8	30	M6X1	CC.T 0602	-	-	M2,5X5	T08

SCMCN 09 ISO

NEW

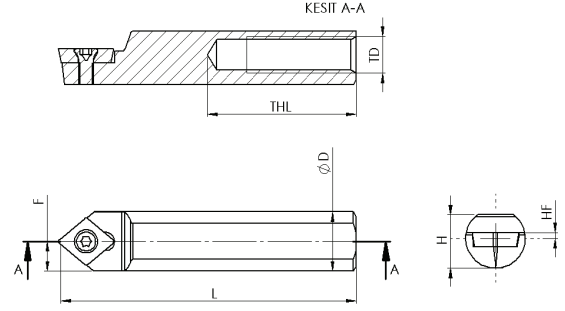
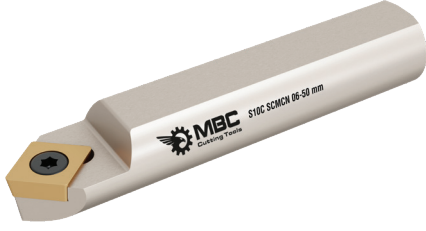

Kesici Uç Uyumluluğu Insert Suitability	Stok Stock	Takım Ölçüleri / Dimension (mm)							Uç Insert	Altlık Shim	Vida Screw	Vida Screw	Anahtar Torx Key
SCMCN 09 ISO		D	H	L	HF	F	THL	TD					
SIPARIŞ KODU Ordering Code													
S 16980	✓	12	11	40	2	6	25	M5X08	CC.T 09T3	-	-	M3,5X11	T15
S 16981	✓	12	11	50	2	6	25	M5X08	CC.T 09T3	-	-	M3,5X11	T15
S 16982	✓	12	11	60	2	6	25	M5X08	CC.T 09T3	-	-	M3,5X11	T15
S 16983	✓	12	11	70	2	6	30	M5X08	CC.T 09T3	-	-	M3,5X11	T15
S 16857	✓	12	11	80	2	6	30	M5X08	CC.T 09T3	-	-	M3,5X11	T15
S 16985	✓	16	15	40	2	8	25	M6X1	CC.T 09T3	-	-	M3,5X11	T15
S 16986	✓	16	15	50	2	8	25	M6X1	CC.T 09T3	-	-	M3,5X11	T15
S 16987	✓	16	15	60	2	8	25	M6X1	CC.T 09T3	-	-	M3,5X11	T15
S 16988	✓	16	15	70	2	8	30	M6X1	CC.T 09T3	-	-	M3,5X11	T15
S 16858	✓	16	15	80	2	8	30	M6X1	CC.T 09T3	-	-	M3,5X11	T15



**SRDCN 10 ISO**

**NEW**

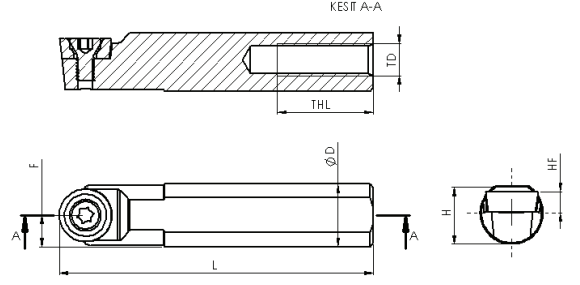

Kesici Uç Uyumluluğu Insert Suitability	Stok Stock	Takım Ölçüleri / Dimension (mm)							Uç İnsert	Vida Screw	Anahtar Torx Key	
SRDCN 10 ISO		D	H	L	HF	F	THL	TD				
SIPARIŞ KODU Ordering Code												
S 16990	✓	12	11	40	3,9	6	25	M5X08	RCMT 10T3	M4X11	T15	
S 16991	✓	12	11	50	3,9	6	25	M5X08	RCMT 10T3	M4X11	T15	
S 16992	✓	12	11	60	3,9	6	25	M5X08	RCMT 10T3	M4X11	T15	
S 16993	✓	12	11	70	3,9	6	30	M5X08	RCMT 10T3	M4X11	T15	
S 16994	✓	12	11	80	3,9	6	30	M5X08	RCMT 10T3	M4X11	T15	
S 16995	✓	16	15	40	3,9	8	25	M6X1	RCMT 10T3	M4X11	T15	
S 16996	✓	16	15	50	3,9	8	25	M6X1	RCMT 10T3	M4X11	T15	
S 16997	✓	16	15	60	3,9	8	25	M6X1	RCMT 10T3	M4X11	T15	
S 16998	✓	16	15	70	3,9	8	30	M6X1	RCMT 10T3	M4X11	T15	
S 16999	✓	16	15	80	3,9	8	30	M6X1	RCMT 10T3	M4X11	T15	



## C-SİSTEM İÇ ÇAP TORNALAMA KATERLERİ C-SYSTEM INTERNAL TURNING TOOLHOLDERS

### CKUNR ISO



93°

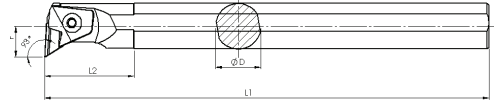

Kesici Uç Uyumluluğu Insert Suitability		Stok Stock	Takım Ölçüleri / Dimension (mm)								Uç Insert	Altlık Shim	Vida Screw	Pabuç Clamp	Vida Screw	Anahtar Allen Key
CKUNR ISO			D	D min	F	L1	L2	λF	YP							
SIPARIŞ KODU - R Ordering Code - R	SIPARIŞ KODU - L Ordering Code - L															
S 6871	S 6868	✓	25	32	17	250	50	-12	-5	KNUX 1604	KNUX 16	M3X8	C160105	M6X27	A3	
S 6872	S 6869	✓	32	40	22	300	60	-12	-5	KNUX 1604	KNUX 16	M3X8	C160105	M6X27	A3	
S 6873	S 6870	✓	40	50	27	400	65	-9	-5	KNUX 1604	KNUX 16	M3X8	C160105	M6X27	A3	
S 6874	X	✓	50	63	35	450	70	-7	-5	KNUX 1604	KNUX 16	M3X8	C160105	M6X27	A3	
S 6875	X	✓	60	75	40	450	70	-7	-5	KNUX 1604	KNUX 16	M3X8	C160105	M6X27	A3	

### CTUPR ISO



93°

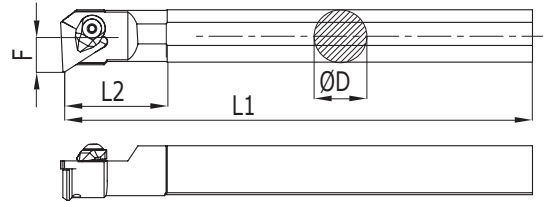

Kesici Uç Uyumluluğu Insert Suitability		Stok Stock	Takım Ölçüleri / Dimension (mm)								Uç Insert	Altlık Shim	Vida Screw	Pabuç Clamp	Vida Screw	Anahtar Allen Key
CTUPR ISO			D	D min	F	L1	L2	λF	YP							
SIPARIŞ KODU - R Ordering Code - R	SIPARIŞ KODU - L Ordering Code - L															
S 14222	X	✓	16	20	11	180	35	-8	-	TPKN 1603	-	-	C160105	M5X23	A3	
S 6888	X	✓	20	25	13	200	40	-8	-	TPKN 1603	-	-	C160105	M5X23	A3	
S 6889	S 6886	✓	25	32	17	250	50	-8	-	TPKN 1603	TC.. 16	M4X10	C160105	M5X23	A3	

### TDUNR ISO



93°

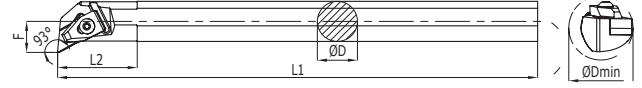

Kesici Uç Uyumluluğu Insert Suitability		Stok Stock	Takım Ölçüleri / Dimension (mm)							Uç Insert	Altık Shim	Vida Screw	Pabuç Clamp	Vida Screw	Anahtar Allen Key
TDUNR ISO			D	D min	F	L1	L2	λF	YP						
SİPARİŞ KODU - R Ordering Code - R	SİPARİŞ KODU - L Ordering Code - L														
\$ 9657	\$ 9651	✓	20	25	13	200	40	-11	-5	DNM. 1104	DNMG 11	M4X10	T110105	M5X23	A3
\$ 9658	\$ 9652	✓	25	32	17	250	50	-13	-5	DNM. 1506	DNMG 15	M4X10	T150105	M6X27	A3
\$ 9659	\$ 9653	✓	32	40	22	300	60	-12	-5	DNM. 1506	DNMG 15	M4X10	T150105	M6X27	A3
\$ 9660	\$ 9654	✓	40	50	27	400	70	-12	-5	DNM. 1506	DNMG 15	M4X10	T150105	M6X27	A3
\$ 9661	\$ 9655	✓	50	63	35	450	75	-12	-5	DNM. 1506	DNMG 15	M4X10	T150105	M6X27	A3
\$ 9662	\$ 9656	✓	60	75	40	450	75	-12	-5	DNM. 1506	DNMG 15	M4X10	T150105	M6X27	A3

### TDQNR ISO



107,5°

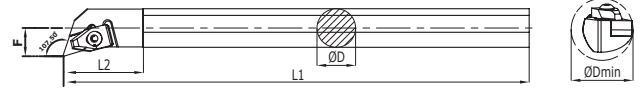

Kesici Uç Uyumluluğu Insert Suitability		Stok Stock	Takım Ölçüleri / Dimension (mm)							Uç Insert	Altık Shim	Vida Screw	Pabuç Clamp	Vida Screw	Anahtar Allen Key
TDQNR ISO			D	D min	F	L1	L2	λF	YP						
SİPARİŞ KODU - R Ordering Code - R	SİPARİŞ KODU - L Ordering Code - L														
\$ 9647	\$ 9643	✓	25	32	17	250	50	-13	-5	DNM. 1506	DNMG 15	M4X10	T150105	M6X27	A3
\$ 9648	\$ 9644	✓	32	40	22	300	60	-12	-5	DNM. 1506	DNMG 15	M4X10	T150105	M6X27	A3
\$ 9649	\$ 9645	✓	40	50	27	400	70	-12	-5	DNM. 1506	DNMG 15	M4X10	T150105	M6X27	A3
\$ 9650	\$ 9646	✓	50	63	35	450	75	-12	-5	DNM. 1506	DNMG 15	M4X10	T150105	M6X27	A3
\$ 16842	\$ 16841	✓	60	75	40	450	75	-12	-5	DNM. 1506	DNMG 15	M4X10	T150105	M6X27	A3

### TD-NR ISO



62,5°

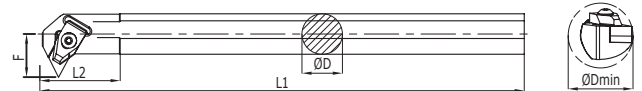

Kesici Uç Uyumluluğu Insert Suitability		Stok Stock	Takım Ölçüleri / Dimension (mm)							Uç Insert	Altık Shim	Vida Screw	Pabuç Clamp	Vida Screw	Anahtar Allen Key
TD-NR ISO			D	D min	F	L1	L2	λF	YP						
SİPARİŞ KODU - R Ordering Code - R	SİPARİŞ KODU - L Ordering Code - L														
\$ 9640	\$ 9631	✓	32	43	26,5	300	60	-15	0	DNM. 1506	DNMG 15	M4X10	T150105	M6X27	A3
\$ 9641	\$ 9632	✓	40	50	29,5	400	70	-13	0	DNM. 1506	DNMG 15	M4X10	T150105	M6X27	A3
\$ 9642	x	✓	50	62	35	450	70	-13	0	DNM. 1506	DNMG 15	M4X10	T150105	M6X27	A3

### TCLNR ISO



95°

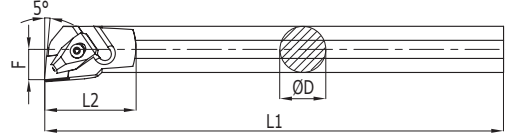

Kesici Uç Uyumluluğu Insert Suitability		Stok Stock	Takım Ölçüleri / Dimension (mm)							Uç Insert	Altlık Shim	Vida Screw	Pabuç Clamp	Vida Screw	Anahtar Allen Key
TCLNR ISO			D	D min	F	L1	L2	λF	YP						
SIPARIŞ KODU - R Ordering Code - R	SIPARIŞ KODU - L Ordering Code - L														
\$ 12763	\$ 14182	✓	20	25	13	200	40	-11	-5	CNMG 1204	CNMG 12	M4X10	T120105	M6X27	A3
\$ 9592	\$ 9576	✓	25	32	17	250	50	-12	-5	CNMG 1204	CNMG 12	M4X10	T120105	M6X27	A3
\$ 9593	\$ 9577	✓	32	40	22	300	60	-12	-5	CNMG 1204	CNMG 12	M4X10	T120105	M6X27	A3
\$ 9596	\$ 9580	✓	32	40	22	300	60	-12	-5	CNMG 1606	CNMG 16	M5X8	T160105	M6X27	A3
\$ 9597	\$ 9581	✓	40	50	27	400	70	-12	-5	CNMG 1204	CNMG 12	M4X10	T120105	M6X27	A3
\$ 9594	\$ 12873	✓	40	50	27	400	70	-12	-5	CNMG 1606	CNMG 16	M5X8	T160105	M6X27	A3
\$ 9599	\$ 9578	✓	40	50	27	400	70	-12	-5	CNMG 1906	CNMG 19	M5X8	T190105	M8X25	A5
\$ 16718	x	✓	50	63	35	450	75	-12	-5	CNMG 1204	CNMG 12	M4X10	T120105	M6X27	A3
\$ 9595	\$ 9579	✓	50	63	35	450	75	-12	-5	CNMG 1606	CNMG 16	M5X8	T160105	M6X27	A3
\$ 9600	x	✓	50	63	35	450	75	-12	-5	CNMG 1906	CNMG 19	M5X8	T190105	M8X25	A5
\$ 9598	\$ 9582	✓	60	75	40	450	75	-12	-5	CNMG 1606	CNMG 16	M5X8	T160105	M6X27	A3

### TWLNR ISO



95°

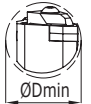
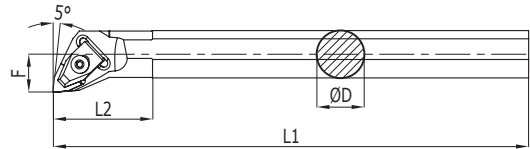

Kesici Uç Uyumluluğu Insert Suitability		Stok Stock	Takım Ölçüleri / Dimension (mm)							Uç Insert	Altlık Shim	Vida Screw	Pabuç Clamp	Vida Screw	Anahtar Allen Key
TWLNR ISO			D	D min	F	L1	L2	λF	YP						
SIPARIŞ KODU - R Ordering Code - R	SIPARIŞ KODU - L Ordering Code - L														
\$ 10639	\$ 10624	✓	20	25	13	200	40	-11	-5	WNMG 0604	-	-	T060105	M5X20	A3
\$ 10641	\$ 10625	✓	25	32	17	250	50	-13	-5	WNMG 0804	WNMG 08	M4X10	T080105	M6X27	A3
\$ 10643	\$ 10626	✓	32	40	22	300	60	-12	-5	WNMG 0804	WNMG 08	M4X10	T080105	M6X27	A3
\$ 10644	\$ 10627	✓	40	50	27	400	70	-12	-5	WNMG 0804	WNMG 08	M4X10	T080105	M6X27	A3
\$ 10645	\$ 10628	✓	50	63	35	450	75	-12	-5	WNMG 0804	WNMG 08	M4X10	T080105	M6X27	A3
\$ 10646	\$ 10629	✓	60	75	40	450	75	-12	-5	WNMG 0804	WNMG 08	M4X10	T080105	M6X27	A3

# M-SİSTEM İÇ ÇAP TORNALAMA KATERLERİ

## M-SYSTEM INTERNAL TURNING TOOLHOLDERS

### MTUNR ISO



93°

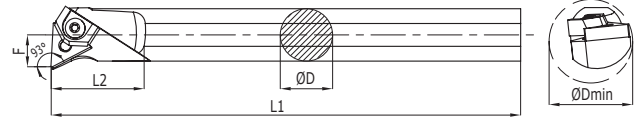

Kesici Uç Uyumluluğu Insert Suitability		Stok Stock	Takım Ölçüleri / Dimension (mm)							Uç Insert	Altlık Shim	Vida Screw	Pabuç Clamp	Vida Screw	Anahtar Allen Key
MTUNR ISO			D	D min	F	L1	L2	λF	YP						
SİPARİŞ KODU - R Ordering Code - R	SİPARİŞ KODU - L Ordering Code - L														
S 7590	S 7582	✓	20	25	13	200	40	-13	-5	TNMG 1604	-	5X3,6X12,5	M160105	M5X15	A3
S 7591	S 7583	✓	25	32	17	250	50	-12	-5	TNMG 1604	TNMG 16	5X3,6X15	M160105	M5X23	A3
S 7592	S 7584	✓	32	40	22	300	60	-12	-5	TNMG 1604	TNMG 16	5X3,6X15	M160105	M5X23	A3
S 7593	S 7585	✓	40	50	27	400	70	-12	-5	TNMG 1604	TNMG 16	5X3,6X15	M160105	M5X23	A3
S 7594	S 7586	✓	32	40	22	300	60	-12	-5	TNMG 2204	TNMG 22	6X5X15	M220105	M6X27	A3
S 7595	S 7587	✓	40	50	27	400	70	-12	-5	TNMG 2204	TNMG 22	6X5X15	M220105	M6X27	A3
S 7596	S 7588	✓	50	63	35	450	75	-12	-5	TNMG 2204	TNMG 22	6X5X15	M220105	M6X27	A3
S 7597	S 7589	✓	60	75	40	450	75	-12	-5	TNMG 2204	TNMG 22	6X5X15	M220105	M6X27	A3

### MT-NR ISO



60°

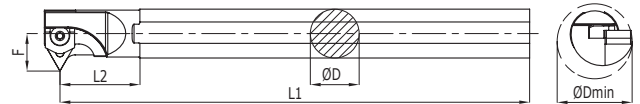

Kesici Uç Uyumluluğu Insert Suitability		Stok Stock	Takım Ölçüleri / Dimension (mm)							Uç Insert	Altlık Shim	Vida Screw	Pabuç Clamp	Vida Screw	Anahtar Allen Key
MT-NR ISO			D	D min	F	L1	L2	λF	YP						
SİPARİŞ KODU - R Ordering Code - R	SİPARİŞ KODU - L Ordering Code - L														
S 7563	S 7558	✓	20	27	16	200	40	-15	0	TNMG 1604	-	5X3,6X12,5	M160105	M5X15	A3
S 7564	S 7559	✓	25	33	19,5	250	50	-14	0	TNMG 1604	TNMG 16	5X3,6X15	M160105	M5X23	A3
S 7565	S 7560	✓	32	40	23	300	55	-13	0	TNMG 1604	TNMG 16	5X3,6X15	M160105	M5X23	A3
S 7566	S 7561	✓	40	50	29,5	400	70	-15	0	TNMG 1604	TNMG 16	5X3,6X15	M160105	M5X23	A3
S 7568	X	✓	32	40	23	300	55	-13	0	TNMG 2204	TNMG 22	6X5X15	M220105	M6X27	A3
S 7569	X	✓	40	50	29,5	400	70	-15	0	TNMG 2204	TNMG 22	6X5X15	M220105	M6X27	A3
S 7567	S 7562	✓	50	32	35	450	70	-15	0	TNMG 2204	TNMG 22	6X5X15	M220105	M6X27	A3

**MTQNR ISO**



107,5°

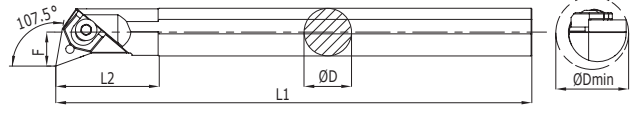

Kesici Uç Uyumluluğu Insert Suitability		Stok Stock	Takım Ölçüleri / Dimension (mm)							Uç Insert	Altlık Shim	Vida Screw	Pabuç Clamp	Vida Screw	Anahtar Allen Key
MTQNR ISO			D	D min	F	L1	L2	ΛF	YP						
SİPARİŞ KODU - R Ordering Code - R	SİPARİŞ KODU - L Ordering Code - L														
S 7576	S 7570	✓	20	25	13	200	40	-13	-5	TNMG 1604	-	5X3,6X12,5	M160105	M5X15	A3
S 7577	S 7571	✓	25	32	17	250	50	-12	-5	TNMG 1604	TNMG 16	5X3,6X15	M160105	M5X23	A3
S 7578	S 7572	✓	32	40	22	300	60	-11	-5	TNMG 1604	TNMG 16	5X3,6X15	M160105	M5X23	A3
S 7579	S 7573	✓	40	50	27	400	70	-11	-5	TNMG 1604	TNMG 16	5X3,6X15	M160105	M5X23	A3
S 7580	S 7574	✓	32	40	22	300	60	-11	-5	TNMG 2204	TNMG 22	6X5X15	M220105	M6X27	A3
S 7581	S 7575	✓	40	50	27	400	70	-11	-5	TNMG 2204	TNMG 22	6X5X15	M220105	M6X27	A3

**MWLN R ISO**



95°

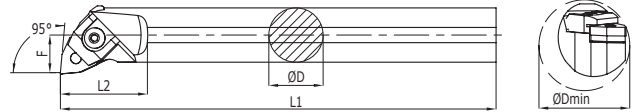

Kesici Uç Uyumluluğu Insert Suitability		Stok Stock	Takım Ölçüleri / Dimension (mm)							Uç Insert	Altlık Shim	Vida Screw	Pabuç Clamp	Vida Screw	Anahtar Allen Key
MWLN R ISO			D	D min	F	L1	L2	ΛF	YP						
SİPARİŞ KODU - R Ordering Code - R	SİPARİŞ KODU - L Ordering Code - L														
S 7626	S 7612	✓	16	22	11	180	35	-13	-5	WNMG 0604	-	5X3,6X12,5	M060105	M5X15	A3
S 7627	S 7613	✓	20	25	13	200	40	-13	-5	WNMG 0604	-	5X3,6X12,5	M060105	M5X15	A3
S 7628	S 7614	✓	25	32	17	250	50	-13	-5	WNMG 0804	WNMG 08	6X5X15	M080105	M6X27	A3
S 7629	S 7615	✓	32	40	22	300	60	-12	-5	WNMG 0804	WNMG 08	6X5X15	M080105	M6X27	A3
S 7630	S 7616	✓	40	50	27	400	70	-12	-5	WNMG 0804	WNMG 08	6X5X15	M080105	M6X27	A3
S 7631	S 7617	✓	50	63	35	450	75	-12	-5	WNMG 0804	WNMG 08	6X5X15	M080105	M6X27	A3
S 7632	S 7618	✓	60	75	40	450	75	-12	-5	WNMG 0804	WNMG 08	6X5X15	M080105	M6X27	A3

### PCLNR ISO



95°

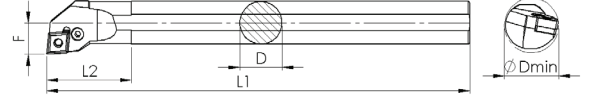

Kesici Uç Uyumluluğu Insert Suitability		Stok Stock	Takım Ölçüleri / Dimension (mm)							Uç Insert	Altlık Shim	Vida Screw	Levye Crowbar	Altlık Sacı Metal Sheet	Anahtar Allen Key
PCLNR ISO			D	D min	F	L1	L2	λF	YP						
SİPARİŞ KODU - R Ordering Code - R	SİPARİŞ KODU - L Ordering Code - L														
S 11204	S 15397	✓	25	32	17	250	50	-12	-5	CNMG 1204	CNMG 12	MPV M8K	MPL 012	MPS 012	A3
S 11205	S 15398	✓	32	40	22	300	60	-12	-5	CNMG 1204	CNMG 12	MPV M8K	MPL 012	MPS 012	A3
S 7687	S 13102	✓	40	50	27	400	70	-12	-5	CNMG 1204	CNMG 12	MPV M8K	MPL 012	MPS 012	A3
S 7688	S 21217	✓	32	40	22	300	60	-12	-5	CNMG 1606	CNMG 16	MPV M8U	MPL 016	MPS 016	A4
S 7689	S 21218	✓	40	50	27	400	70	-12	-5	CNMG 1606	CNMG 16	MPV M8U	MPL 016	MPS 016	A4
S 7690	S 21219	✓	40	50	27	400	70	-12	-5	CNMG 1906	CNMG 19	MPV M8U	MPL 019	MPS 019	A4
S 21281	S 21282	✓	50	63	35	450	75	-12	-5	CNMG 1606	CNMG 16	MPV M8U	MPL 016	MPS 016	A4
S 7691	S 21220	✓	50	63	35	450	75	-12	-5	CNMG 1906	CNMG 19	MPV M8U	MPL 019	MPS 019	A4

### PDUNR ISO



93°

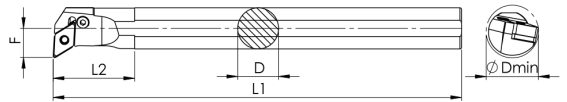

Kesici Uç Uyumluluğu Insert Suitability		Stok Stock	Takım Ölçüleri / Dimension (mm)							Uç Insert	Altlık Shim	Vida Screw	Levye Crowbar	Altlık Sacı Metal Sheet	Anahtar Allen Key
PDUNR ISO			D	D min	F	L1	L2	λF	YP						
SİPARİŞ KODU - R Ordering Code - R	SİPARİŞ KODU - L Ordering Code - L														
S 7696	S 21213	✓	25	32	17	250	50	-13	-5	DNM. 1506	DNMG 15	MPV M8K	MPL 015	MPS 015	A3
S 7697	S 21214	✓	32	40	22	300	60	-12	-5	DNM. 1506	DNMG 15	MPV M8K	MPL 015	MPS 015	A3
S 7698	S 21215	✓	40	50	27	400	70	-12	-5	DNM. 1506	DNMG 15	MPV M8K	MPL 015	MPS 015	A3
S 17088	S 21216	✓	50	63	35	450	75	-12	-5	DNM. 1506	DNMG 15	MPV M8K	MPL 015	MPS 015	A3

### PDQNR ISO

NEW



107,5°

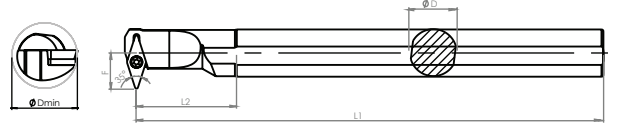

Kesici Uç Uyumluluğu Insert Suitability		Stok Stock	Takım Ölçüleri / Dimension (mm)							Uç Insert	Altık Shim	Vida Screw	Levyeye Crowbar	Altık Sacı Metal Sheet	Anahtar Allen Key
PDQNR ISO			D	D min	F	L1	L2	λF	YP						
SIPARIŞ KODU - R Ordering Code - R	SIPARIŞ KODU - L Ordering Code - L														
\$ 21254	\$ 21255	✓	25	32	17	250	50	-13	-5	DNM. 1506	DNMG 15	MPV M8K	MPL 015	MPS 015	A3
\$ 21256	\$ 21257	✓	32	40	22	300	60	-12	-5	DNM. 1506	DNMG 15	MPV M8K	MPL 015	MPS 015	A3
\$ 21258	\$ 21259	✓	40	50	27	400	70	-12	-5	DNM. 1506	DNMG 15	MPV M8K	MPL 015	MPS 015	A3
\$ 21260	\$ 21261	✓	50	63	35	450	75	-12	-5	DNM. 1506	DNMG 15	MPV M8K	MPL 015	MPS 015	A3

### PWLNK ISO

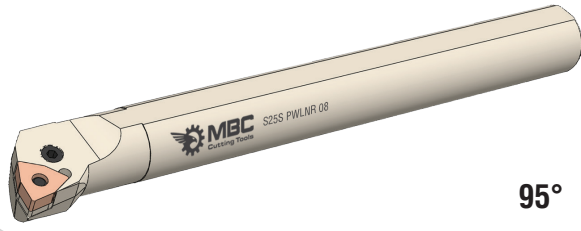

95°

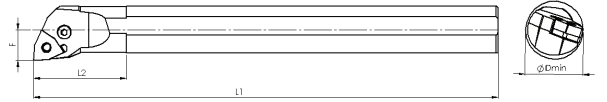

Kesici Uç Uyumluluğu Insert Suitability		Stok Stock	Takım Ölçüleri / Dimension (mm)							Uç Insert	Altık Shim	Vida Screw	Levyeye Crowbar	Altık Sacı Metal Sheet	Anahtar Allen Key
PWLNK ISO			D	D min	F	L1	L2	λF	YP						
SIPARIŞ KODU - R Ordering Code - R	SIPARIŞ KODU - L Ordering Code - L														
\$ 11206	\$ 21221	✓	25	32	17	250	50	-13	-6	WNMG 0804	WNMG 08	MPV M8K	MPL 08	MPS 08	A3
\$ 7764	\$ 21222	✓	32	40	22	300	60	-12	-6	WNMG 0804	WNMG 08	MPV M8K	MPL 08	MPS 08	A3
\$ 7763	\$ 21223	✓	40	50	27	400	70	-12	-6	WNMG 0804	WNMG 08	MPV M8K	MPL 08	MPS 08	A3
\$ 17090	\$ 21224	✓	50	63	35	450	75	-12	-6	WNMG 0804	WNMG 08	MPV M8K	MPL 08	MPS 08	A3

### PTUNR ISO



93°

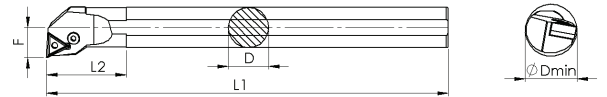

Kesici Uç Uyumluluğu Insert Suitability		Stok Stock	Takım Ölçüleri / Dimension (mm)							Uç Insert	Altık Shim	Vida Screw	Levyeye Crowbar	Altık Sacı Metal Sheet	Anahtar Allen Key
PTUNR ISO			D	D min	F	L1	L2	λF	YP						
SIPARIŞ KODU - R Ordering Code - R	SIPARIŞ KODU - L Ordering Code - L														
\$ 7752	x	✓	20	25	13	200	40	-13	-5	TNMG 1604	-	MPV M8K	MPL 016	MSP 016	A3
\$ 7753	\$ 21211	✓	25	32	17	250	50	-12	-5	TNMG 1604	TNMG 16	MPV M8K	MPL 016	MSP 016	A3
\$ 7754	\$ 21209	✓	32	40	22	300	60	-12	-5	TNMG 1604	TNMG 16	MPV M8K	MPL 016	MSP 016	A3
\$ 21242	\$ 21241	✓	40	50	27	40	70	-12	-5	TNMG 1604	TNMG 16	MPV M8K	MPL 016	MSP 016	A3
\$ 7755	x	✓	32	40	22	300	60	-12	-5	TNMG 2204	TNMG 22	MPV M8U	MPL 022	MPS 022	A3
\$ 7756	\$ 21225	✓	40	50	27	400	70	-12	-5	TNMG 2204	TNMG 22	MPV M8U	MPL 022	MPS 022	A3
\$ 17089	\$ 21289	✓	50	63	35	450	75	-12	-5	TNMG 2204	TNMG 22	MPV M8U	MPL 022	MPS 022	A3



## ŞAFTLI TARAMALAR END MILLS

### ISO AP..1003

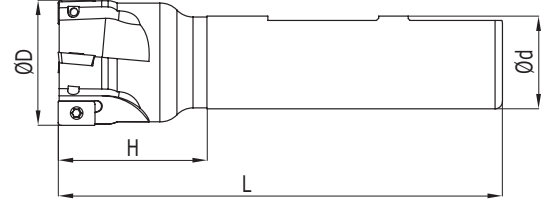

Kesici Uç Uyumluluğu Insert Suitability		Stok Stock	Takım Ölçüleri / Dimension (mm)					Uç Insert	Vida Screw	Anahtar Torx Key
ISO AP..1003			D	Z	H	L	d			
SİPARİŞ KODU Ordering Code	SİPARİŞ KODU Ordering Code Inter Coolant									
ST 12609	ST 12398	✓	12	1	40	100	12	APKT 1003	M2,5X6	T08
ST 8389	ST 8390	✓	12	1	40	120	12	APKT 1003	M2,5X6	T08
ST 8391	X	✓	14	1	30	120	12	APKT 1003	M2,5X6	T08
ST 8392	ST 8393	✓	16	2	35	100	16	APKT 1003	M2,5X6	T08
ST 8394	ST 8395	✓	16	2	40	120	16	APKT 1003	M2,5X6	T08
ST 8396	ST 8397	✓	16	2	50	150	16	APKT 1003	M2,5X6	T08
ST 8398	ST 8399	✓	16	2	50	200	16	APKT 1003	M2,5X6	T08
ST 8400	X	✓	16	2	60	250	16	APKT 1003	M2,5X6	T08
ST 12214	X	✓	17	2	30	150	16	APKT 1003	M2,5X6	T08
ST 8401	ST 8402	✓	18	2	30	100	16	APKT 1003	M2,5X6	T08
ST 8403	ST 8404	✓	18	2	30	120	16	APKT 1003	M2,5X6	T08
ST 8405	ST 8406	✓	18	2	30	150	16	APKT 1003	M2,5X6	T08
ST 8407	ST 8408	✓	18	2	30	200	16	APKT 1003	M2,5X6	T08
ST 8413	X	✓	18	2	30	250	16	APKT 1003	M2,5X6	T08
ST 8409	ST 8410	✓	20	3	35	100	20	APKT 1003	M2,5X7	T08
ST 8411	ST 8412	✓	20	3	40	120	20	APKT 1003	M2,5X7	T08
ST 8414	ST 8415	✓	20	3	50	150	20	APKT 1003	M2,5X7	T08
ST 8416	ST 8417	✓	20	3	60	200	20	APKT 1003	M2,5X7	T08
ST 8418	X	✓	20	3	60	250	20	APKT 1003	M2,5X7	T08
ST 12215	X	✓	21	3	30	150	20	APKT 1003	M2,5X7	T08
ST 12260	X	✓	21	3	30	200	20	APKT 1003	M2,5X7	T08
ST 8419	ST 8420	✓	22	3	30	100	20	APKT 1003	M2,5X7	T08
ST 8421	ST 8422	✓	22	3	30	120	20	APKT 1003	M2,5X7	T08
ST 8423	ST 8424	✓	22	3	30	150	20	APKT 1003	M2,5X7	T08
ST 8425	X	✓	22	3	30	200	20	APKT 1003	M2,5X7	T08
ST 8426	X	✓	22	3	30	250	20	APKT 1003	M2,5X7	T08
ST 8427	ST 8428	✓	25	3	35	100	25	APKT 1003	M2,5X7	T08
ST 8429	ST 8430	✓	25	3	40	120	25	APKT 1003	M2,5X7	T08
ST 8431	ST 8432	✓	25	3	50	150	25	APKT 1003	M2,5X7	T08
ST 8433	ST 8434	✓	25	3	60	200	25	APKT 1003	M2,5X7	T08

ISO AP..1003

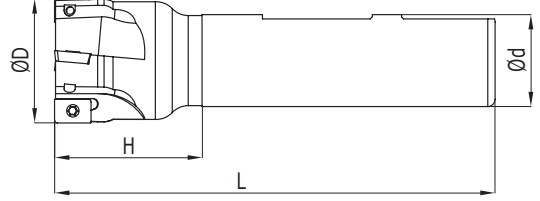

Kesici Uç Uyumluluğu Insert Suitability		Stok Stock	Takım Ölçüleri / Dimension (mm)					Uç Insert	Vida Screw	Anahtar Torx Key
ISO AP..1003			D	Z	H	L	d			
SİPARİŞ KODU Ordering Code	SİPARİŞ KODU Ordering Code Inter Coolant									
ST 8435	X	✓	25	3	60	250	25	APKT 1003	M2,5X7	T08
ST 8437	X	✓	26	3	30	150	25	APKT 1003	M2,5X7	T08
ST 8438	X	✓	26	3	30	200	25	APKT 1003	M2,5X7	T08
ST 8439	X	✓	26	3	30	250	25	APKT 1003	M2,5X7	T08
ST 8436	X	✓	28	4	30	150	25	APKT 1003	M2,5X7	T08
ST 8440	ST 8441	✓	30	4	30	100	25	APKT 1003	M2,5X7	T08
ST 8442	ST 8443	✓	30	4	30	120	25	APKT 1003	M2,5X7	T08
ST 8444	X	✓	30	3	30	150	25	APKT 1003	M2,5X7	T08
ST 8445	ST 8446	✓	30	4	30	150	25	APKT 1003	M2,5X7	T08
ST 8447	ST 8448	✓	30	4	30	200	25	APKT 1003	M2,5X7	T08
ST 8451	X	✓	32	4	40	150	25	APKT 1003	M2,5X7	T08
ST 8452	X	✓	32	4	50	150	32	APKT 1003	M2,5X7	T08
ST 8454	ST 8453	✓	32	4	60	200	32	APKT 1003	M2,5X7	T08
ST 8456	ST 8455	✓	35	4	40	100	25	APKT 1003	M2,5X7	T08
ST 8458	X	✓	35	4	40	120	25	APKT 1003	M2,5X7	T08
ST 8460	ST 8459	✓	35	4	40	150	25	APKT 1003	M2,5X7	T08
ST 8461	X	✓	35	4	40	200	25	APKT 1003	M2,5X7	T08
ST 8463	X	✓	35	4	35	100	32	APKT 1003	M2,5X7	T08
ST 8466	X	✓	35	4	40	120	32	APKT 1003	M2,5X7	T08
ST 8467	X	✓	35	4	50	150	32	APKT 1003	M2,5X7	T08
ST 8469	ST 8470	✓	40	5	40	100	25	APKT 1003	M2,5X7	T08
ST 8471	ST 8472	✓	40	5	40	120	25	APKT 1003	M2,5X7	T08
ST 8473	ST 8474	✓	40	5	40	150	25	APKT 1003	M2,5X7	T08
ST 8475	ST 8476	✓	40	5	40	200	25	APKT 1003	M2,5X7	T08
ST 8478	ST 8479	✓	40	5	40	120	32	APKT 1003	M2,5X7	T08
ST 8480	ST 8481	✓	40	5	40	150	32	APKT 1003	M2,5X7	T08
ST 8482	ST 8483	✓	40	5	40	150	32	APKT 1003	M2,5X7	T08

### ISO AP.1604

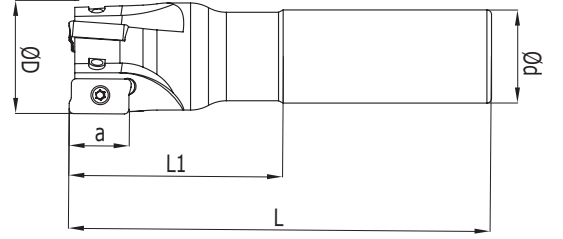

Kesici Uç Uyumluluğu Insert Suitability ISO AP..1604		Stok Stock	Takım Ölçüleri / Dimension (mm)					Uç İnsert	Vida Screw	Anahtar Torx Key
SİPARİŞ KODU Ordering CodeR	SİPARİŞ KODU Ordering Code Inter Cooland		D	Z	H	L	d			
ST 8572	X	✓	23,5	2	30	150	25	APKT 1604	M3,5X8	T15
ST 8573	X	✓	24	2	30	150	25	APKT 1604	M3,5X8	T15
ST 8490	ST 8491	✓	25	2	70	100	25	APKT 1604	M3,5X8	T15
ST 8492	ST 8493	✓	25	2	41	120	25	APKT 1604	M3,5X8	T15
ST 8495	ST 8496	✓	25	2	50	150	25	APKT 1604	M3,5X8	T15
ST 8498	ST 8499	✓	25	2	70	200	25	APKT 1604	M3,5X8	T15
ST 8501	X	✓	25	2	70	250	25	APKT 1604	M3,5X8	T15
ST 8503	X	✓	25	2	70	300	25	APKT 1604	M3,5X8	T15
ST 8505	ST 8504	✓	30	3	41	100	25	APKT 1604	M3,5X10	T15
ST 8508	ST 8507	✓	30	3	41	120	25	APKT 1604	M3,5X10	T15
ST 8510	ST 8511	✓	30	3	41	150	25	APKT 1604	M3,5X10	T15
ST 8513	ST 8514	✓	30	3	41	200	25	APKT 1604	M3,5X10	T15
ST 8515	X	✓	30	3	41	250	25	APKT 1604	M3,5X10	T15
ST 8516	X	✓	30	3	41	300	25	APKT 1604	M3,5X10	T15
ST 8517	ST 8518	✓	32	3	41	100	25	APKT 1604	M3,5X10	T15
ST 8519	ST 8520	✓	32	3	41	120	25	APKT 1604	M3,5X10	T15
ST 8521	ST 8522	✓	32	3	41	150	25	APKT 1604	M3,5X10	T15
ST 8523	ST 8524	✓	32	3	41	200	25	APKT 1604	M3,5X10	T15
ST 8525	ST 8526	✓	32	3	35	100	32	APKT 1604	M3,5X10	T15
ST 8527	ST 8528	✓	32	3	35	120	32	APKT 1604	M3,5X10	T15
ST 8529	ST 8530	✓	32	3	50	150	32	APKT 1604	M3,5X10	T15
ST 8531	ST 8532	✓	32	3	60	200	32	APKT 1604	M3,5X10	T15
ST 8533	X	✓	32	3	70	250	32	APKT 1604	M3,5X10	T15
ST 8534	X	✓	32	3	70	300	32	APKT 1604	M3,5X10	T15
ST 8535	X	✓	32	3	100	350	32	APKT 1604	M3,5X10	T15
ST 8574	X	✓	32	3	30	250	25	APKT 1604	M3,5X10	T15
ST 8536	X	✓	35	3	41	100	25	APKT 1604	M3,5X10	T15
ST 8538	X	✓	35	3	41	120	25	APKT 1604	M3,5X10	T15
ST 8540	X	✓	35	3	55	150	25	APKT 1604	M3,5X10	T15
ST 8542	X	✓	35	3	41	100	32	APKT 1604	M3,5X10	T15
ST 8544	X	✓	35	3	41	120	32	APKT 1604	M3,5X10	T15
ST 8546	ST 8547	✓	35	3	41	150	32	APKT 1604	M3,5X10	T15
ST 8550	X	✓	35	3	41	250	32	APKT 1604	M3,5X10	T15
ST 8551	X	✓	35	3	41	300	32	APKT 1604	M3,5X10	T15
ST 8552	X	✓	35	3	41	350	32	APKT 1604	M3,5X10	T15
ST 8553	ST 8554	✓	40	4	41	100	25	APKT 1604	M3,5X10	T15
ST 8555	ST 8556	✓	40	4	41	120	25	APKT 1604	M3,5X10	T15
ST 8557	ST 8558	✓	40	4	41	150	25	APKT 1604	M3,5X10	T15
ST 8559	ST 8560	✓	40	4	41	200	25	APKT 1604	M3,5X10	T15
ST 8561	ST 8562	✓	40	4	46	100	32	APKT 1604	M3,5X10	T15
ST 8563	ST 8564	✓	40	4	46	120	32	APKT 1604	M3,5X10	T15
ST 8566	ST 8565	✓	40	4	46	150	32	APKT 1604	M3,5X10	T15
ST 8567	ST 8568	✓	40	4	46	200	32	APKT 1604	M3,5X10	T15
ST 8569	X	✓	40	4	46	250	32	APKT 1604	M3,5X10	T15
ST 8570	X	✓	40	4	46	300	32	APKT 1604	M3,5X10	T15
ST 8571	X	✓	40	4	46	350	32	APKT 1604	M3,5X10	T15

## ISO TPKN 16

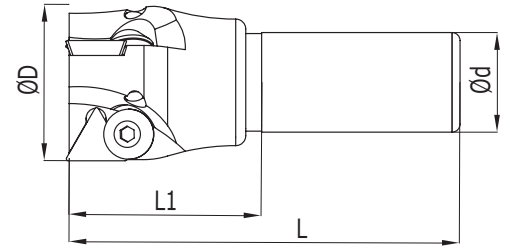

Kesici Uç Uyumluluğu Insert Suitability		Stok Stock	Takım Ölçüleri / Dimension (mm)					Uç Insert	Vida Screw	Anahtar Allen Key
ISO TPKN 16			D	Z	L1	L	d			
SİPARİŞ KODU Ordering Code	SİPARİŞ KODU Ordering Code Inter Coolant									
ST 9306	X	✓	35	2	40	100	25	TPKN 1603	M6X0,75	A4
ST 9307	X	✓	40	3	40	100	25	TPKN 1603	M6X0,75	A4
ST 9308	X	✓	50	3	40	100	25	TPKN 1603	M6X0,75	A4

## ISO VCGT 1604 - 2205

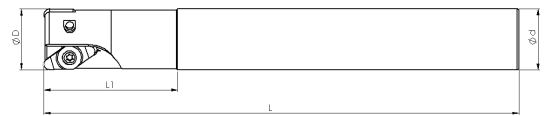

Kesici Uç Uyumluluğu Insert Suitability		Stok Stock	Takım Ölçüleri / Dimension (mm)					Uç Insert	Vida Screw	Anahtar Torx Key
ISO VCGT 1604 - 2205			D	Z	L1	L	d			
SİPARİŞ KODU Ordering Code	SİPARİŞ KODU Ordering Code Inter Coolant									
ST 9316	X	✓	32	2	70	250	32	VCGT 2205	M5X12	T20

**SNG APMT 1135**

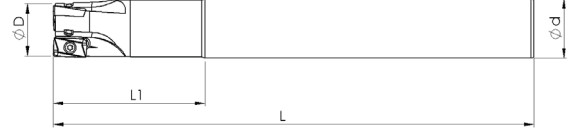

Kesici Uç Uyumluluğu Insert Suitability		Stok Stock	Takım Ölçüleri / Dimension (mm)					Uç Insert	Vida Screw	Anahtar Torx Key
SİPARİŞ KODU Ordering Code	SİPARİŞ KODU Ordering Code Inter Coolant		D	Z	L1	L	d			
SNG APMT 1135										
ST 8667	x	✓	16	2	30	160	15	APMT 1135	M2,5X6	T08
ST 8669	x	✓	16	2	50	160	16	APMT 1135	M2,5X6	T08
ST 8671	ST 12871	✓	16	2	60	200	16	APMT 1135	M2,5X6	T08
ST 8674	ST 14212	✓	17	2	30	160	16	APMT 1135	M2,5X6	T08
ST 11855	x	✓	17	2	30	200	16	APMT 1135	M2,5X6	T08
ST 8678	ST 12978	✓	20	3	50	160	20	APMT 1135	M2,5X6	T08
ST 11293	ST 12872	✓	20	3	60	200	20	APMT 1135	M2,5X6	T08
ST 8681	ST 14213	✓	21	3	30	160	20	APMT 1135	M2,5X6	T08
ST 11294	x	✓	21	3	30	200	20	APMT 1135	M2,5X6	T08
ST 8684	x	✓	25	3	50	160	25	APMT 1135	M2,5X7	T08
ST 8686	ST 12874	✓	25	3	60	200	25	APMT 1135	M2,5X7	T08
ST 8688	x	✓	26	3	30	160	25	APMT 1135	M2,5X7	T08
ST 11296	x	✓	26	3	30	200	25	APMT 1135	M2,5X7	T08
ST 8690	x	✓	32	4	50	160	32	APMT 1135	M2,5X7	T08
ST 8692	x	✓	33	4	40	160	32	APMT 1135	M2,5X7	T08

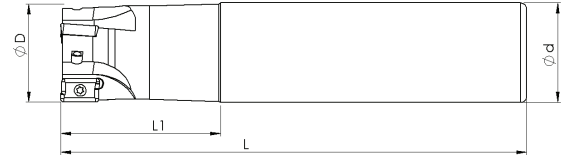

**FTTE ADKX 1204**



Kesici Uç Uyumluluğu Insert Suitability		Stok Stock	Takım Ölçüleri / Dimension (mm)					Uç Insert	Vida Screw	Anahtar Torx Key
SİPARİŞ KODU Ordering Code	SİPARİŞ KODU Ordering Code Inter Coolant		D	Z	L1	L	d			
FTTE ADKX 1204										
ST 8307	x	✓	12	1	30	80	12	ADKX 1204	M3X6	T10
ST 8309	x	✓	16	2	40	140	16	ADKX 1204	M3X6	T10
ST 8313	x	✓	25	2	35	100	25	ADKX 1204	M3X8	T10
ST 8314	x	✓	25	2	50	171	25	ADKX 1204	M3X8	T10
ST 8317	x	✓	32	3	35	111	32	ADKX 1204	M3X8	T10
ST 8318	x	✓	32	3	60	201	32	ADKX 1204	M3X8	T10
ST 8319	x	✓	32	4	60	201	32	ADKX 1204	M3X8	T10

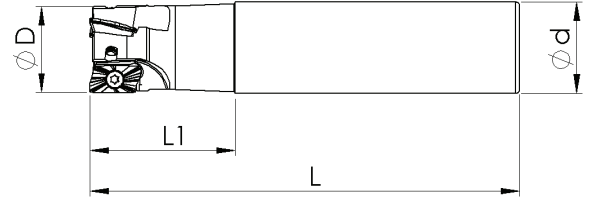

## MTSBH AOMT 1848

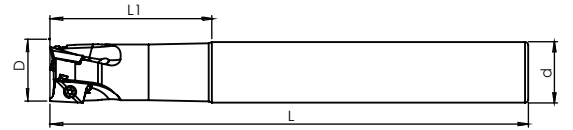

Kesici Uç Uyumluluğu Insert Suitability		Stok Stock	Takım Ölçüleri / Dimension (mm)					Uç Insert	Vida Screw	Anahtar Torx Key
MTSBH AOMT 1848			D	Z	L1	L	d			
SİPARİŞ KODU Ordering Code	SİPARİŞ KODU Ordering Code Inter Coolant									
ST 8375	X	✓	25	2	50	150	25	AOMT 1848	M4X11	T15
ST 8376	X	✓	32	3	50	150	32	AOMT 1848	M4X11	T15

## MTSBH AOMT 1236



Kesici Uç Uyumluluğu Insert Suitability		Stok Stock	Takım Ölçüleri / Dimension (mm)					Uç Insert	Vida Screw	Anahtar Torx Key
MTSBH AOMT 1236			D	Z	L1	L	d			
X	ST 8362	✓	16	2	50	150	16	AOMT 1236	M2,5X6	T08
X	ST 8363	✓	17	2	30	150	16	AOMT 1236	M2,5X6	T08
X	ST 8364	✓	20	3	50	150	20	AOMT 1236	M2,5X6	T08
X	ST 12046	✓	20	3	50	200	20	AOMT 1236	M2,5X6	T08
X	ST 8365	✓	21	3	30	150	20	AOMT 1236	M2,5X6	T08
X	ST 8367	✓	25	4	50	150	25	AOMT 1236	M2,5X7	T08
X	ST 12991	✓	25	4	50	200	25	AOMT 1236	M2,5X7	T08
X	ST 8369	✓	32	4	50	160	32	AOMT 1236	M2,5X7	T08
X	ST 12676	✓	32	4	50	200	32	AOMT 1236	M2,5X7	T08

### SCO XOMX 0903

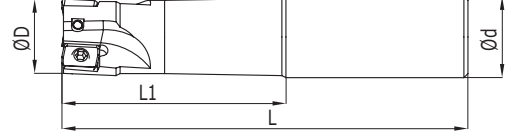

Kesici Uç Uyumluluğu Insert Suitability		Stok Stock	Takım Ölçüleri / Dimension (mm)					Uç İnsert	Vida Screw	Anahtar Torx Key
SCO XOMX 0903			D	Z	L1	L	d			
SİPARİŞ KODU Ordering Code	SİPARİŞ KODU Ordering Code Inter Coolant									
ST 9382	ST 12391	✓	16	2	35	100	16	XO.. 0903	M2,5X6	T08
ST 9383	x	✓	16	2	40	130	16	XO.. 0903	M2,5X6	T08
ST 9384	x	✓	16	2	50	150	16	XO.. 0903	M2,5X6	T08
x	ST 12747	✓	16	2	50	200	16	XO.. 0903	M2,5X6	T08
ST 9386	ST 12392	✓	20	3	40	120	20	XO.. 0903	M2,5X6	T08
ST 9387	ST 14338	✓	20	3	50	150	20	XO.. 0903	M2,5X6	T08
ST 9388	x	✓	20	3	60	200	20	XO.. 0903	M2,5X6	T08
ST 9389	ST 12389	✓	25	3	50	150	25	XO.. 0903	M2,5X7	T08

### SCO XOMX 1204

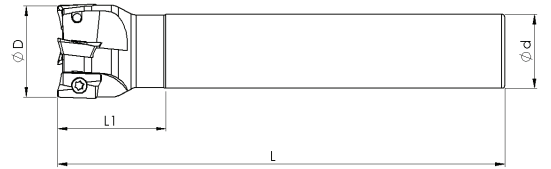

Kesici Uç Uyumluluğu Insert Suitability		Stok Stock	Takım Ölçüleri / Dimension (mm)					Uç İnsert	Vida Screw	Anahtar Torx Key
SCO XOMX 1204			D	Z	L1	L	d			
SİPARİŞ KODU Ordering Code	SİPARİŞ KODU Ordering Code Inter Coolant									
ST 9390	x	✓	16	2	40	120	16	XOMX 1204	M3,5X8X4.80	T15
ST 9391	x	✓	16	1	50	150	16	XOMX 1204	M3,5X8X4.80	T15
ST 9392	x	✓	20	2	35	100	20	XOMX 1204	M3,5X8X4.80	T15
ST 9393	ST 12387	✓	20	2	40	120	20	XOMX 1204	M3,5X8X4.80	T15
ST 9394	x	✓	20	2	50	150	20	XOMX 1204	M3,5X8X4.80	T15
ST 16528	x	✓	21	2	50	150	20	XOMX 1204	M3,5X8X4.80	T15
ST 9400	x	✓	20	2	60	200	20	XOMX 1204	M3,5X8X4.80	T15
ST 9395	x	✓	22	2	30	150	20	XOMX 1204	M3,5X8X4.80	T15
ST 9396	ST 12388	✓	25	3	40	120	25	XOMX 1204	M3,5X8X4.80	T15
ST 9397	ST 12606	✓	25	3	50	150	25	XOMX 1204	M3,5X8X4.80	T15
ST 9399	x	✓	25	3	35	100	25	XOMX 1204	M3,5X8X4.80	T15
ST 9401	x	✓	25	3	60	200	25	XOMX 1204	M3,5X8X4.80	T15
ST 16529	x	✓	26	3	60	200	25	XOMX 1204	M3,5X8X4.80	T15
ST 9398	ST 12390	✓	32	4	40	150	25	XOMX 1204	M3,5X8X4.80	T15
ST 9402	x	✓	32	4	40	250	25	XOMX 1204	M3,5X8X4.80	T15

## SCO XNEX 0403

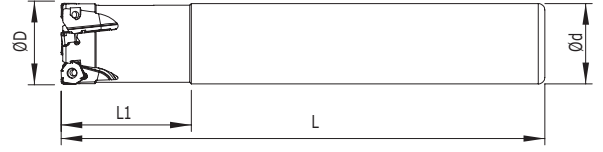

Kesici Uç Uyumluluğu Insert Suitability		Stok Stock	Takım Ölçüleri / Dimension (mm)					Uç Insert	Vida Screw	Anahtar Torx Key
SCO XNEX 0403			D	Z	L1	L	d			
SİPARİŞ KODU Ordering Code	SİPARİŞ KODU Ordering Code Inter Coolant									
X	ST 9371	✓	18	2	35	150	16	XNEX 0403	M2,5X7	T08
X	ST 9372	✓	18	2	30	200	16	XNEX 0403	M2,5X7	T08
X	ST 9373	✓	20	3	50	150	20	XNEX 0403	M2,5X7	T08
X	ST 9374	✓	21	3	30	150	20	XNEX 0403	M2,5X7	T08
X	ST 9375	✓	21	3	30	200	20	XNEX 0403	M2,5X7	T08
X	ST 9376	✓	25	4	50	150	25	XNEX 0403	M2,5X7	T08
X	ST 9379	✓	25	4	60	200	25	XNEX 0403	M2,5X7	T08
X	ST 9377	✓	26	4	30	150	25	XNEX 0403	M2,5X7	T08
X	ST 9380	✓	26	4	30	200	25	XNEX 0403	M2,5X7	T08
X	ST 9378	✓	32	4	50	150	32	XNEX 0403	M2,5X7	T08
X	ST 9381	✓	32	4	60	200	32	XNEX 0403	M2,5X7	T08

## JDMT 0702 DES



90°

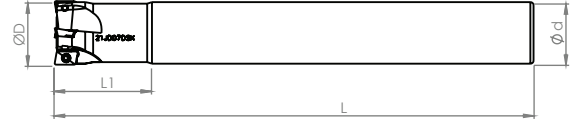

Kesici Uç Uyumluluğu Insert Suitability		Stok Stock	Takım Ölçüleri / Dimension (mm)					Uç Insert	Vida Screw	Anahtar Torx Key
JDMT 0702 DES			D	Z	L1	L	d			
SİPARİŞ KODU Ordering Code	SİPARİŞ KODU Ordering Code Inter Coolant									
ST 14288	X	✓	10	2	30	120	9	JDMT 0702	M1,8X4	T6
ST 14289	X	✓	12	2	30	120	11	JDMT 0702	M1,8X4	T6
ST 16532	X	✓	17	3	30	150	16	JDMT 0702	M1,8X4	T6
ST 16533	X	✓	21	4	30	150	20	JDMT 0702	M1,8X4	T6

## EPHT 0703 TTC

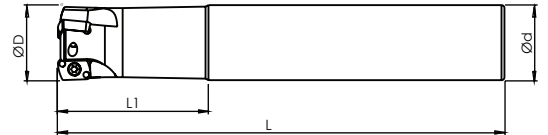

Kesici Uç Uyumluluğu Insert Suitability		Stok Stock	Takım Ölçüleri / Dimension (mm)					Uç Insert	Vida Screw	Anahtar Torx Key
EPHT 0703 TTC			D	Z	L1	L	d			
SİPARİŞ KODU Ordering Code	SİPARİŞ KODU Ordering Code Inter Coolant									
X	ST 12474	✓	16	2	40	150	16	EPHT 0703	M3X8	T10
X	ST 17129	✓	17	2	30	150	16	EPHT 0703	M3X8	T10
X	ST 15412	✓	20	2	40	150	20	EPHT 0703	M3X8	T10
X	ST 17130	✓	21	3	30	150	20	EPHT 0703	M3X8	T10
X	ST 15413	✓	25	3	50	150	25	EPHT 0703	M3X8	T10
X	ST 15414	✓	32	4	50	150	32	EPHT 0703	M3X8	T10

### ZCC APKT 1604

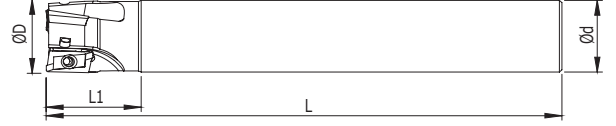

Kesici Uç Uyumluluğu Insert Suitability		Stok Stock	Takım Ölçüleri / Dimension (mm)					Uç Insert	Vida Screw	Anahtar Torx Key
ZCC APKT 1604			D	Z	L1	L	d			
SİPARİŞ KODU Ordering Code	SİPARİŞ KODU Ordering Code Inter Coolant									
ST 8656	X	✓	25	2	50	170	25	APKT 1604	M4X9	T15
ST 12778	X	✓	26	2	30	160	25	APKT 1604	M4X9	T15
ST 8657	X	✓	26	2	30	200	25	APKT 1604	M4X9	T15
ST 8658	X	✓	26	2	30	250	25	APKT 1604	M4X9	T15
ST 16852	X	✓	26	2	30	300	25	APKT 1604	M4X9	T15
ST 8659	X	✓	32	3	50	170	32	APKT 1604	M4X9	T15
ST 12757	X	✓	32	3	50	200	32	APKT 1604	M4X9	T15
ST 8660	X	✓	33	3	40	200	32	APKT 1604	M4X9	T15
ST 8661	X	✓	33	3	40	250	32	APKT 1604	M4X9	T15
ST 8662	X		33	3	40	300	32	APKT 1604	M4X9	T15
ST 8663	X		33	3	40	350	32	APKT 1604	M4X9	T15
ST 8664	X		33	3	40	400	32	APKT 1604	M4X9	T15

### ZCC APKT 11T3



Kesici Uç Uyumluluğu Insert Suitability		Stok Stock	Takım Ölçüleri / Dimension (mm)					Uç Insert	Vida Screw	Anahtar Torx Key
ZCC APKT 11T3			D	Z	L1	L	d			
SİPARİŞ KODU Ordering Code	SİPARİŞ KODU Ordering Code Inter Coolant									
ST 8640	ST 11457	✓	16	2	50	160	16	APKT 11T3	M2,5X6	T08
ST 8642	ST 8641	✓	16	2	60	200	16	APKT 11T3	M2,5X6	T08
ST 11492	X	✓	16	2	35	100	16	APKT 11T3	M2,5X6	T08
ST 8643	X	✓	17	2	30	160	16	APKT 11T3	M2,5X6	T08
ST 8644	X	✓	17	2	30	200	16	APKT 11T3	M2,5X6	T08
ST 8645	X	✓	17	2	30	250	16	APKT 11T3	M2,5X6	T08
ST 8646	X	✓	18	2	30	160	16	APKT 11T3	M2,5X6	T08
ST 8647	ST 11320	✓	20	3	50	160	20	APKT 11T3	M2,5X6	T08
ST 8655	X	✓	20	3	60	200	20	APKT 11T3	M2,5X6	T08
ST 11493	X	✓	20	3	40	120	20	APKT 11T3	M2,5X6	T08
ST 8648	X	✓	21	3	30	160	20	APKT 11T3	M2,5X6	T08
ST 8649	X	✓	21	3	30	200	20	APKT 11T3	M2,5X6	T08
ST 8650	X	✓	21	3	30	250	20	APKT 11T3	M2,5X6	T08
ST 8651	X	✓	25	3	50	160	25	APKT 11T3	M2,5X7	T08
ST 11494	X	✓	25	3	40	120	25	APKT 11T3	M2,5X7	T08
ST 11495	X	✓	25	3	60	200	25	APKT 11T3	M2,5X7	T08
ST 8652	X	✓	26	3	30	150	25	APKT 11T3	M2,5X7	T08
ST 8653	X	✓	26	3	30	200	25	APKT 11T3	M2,5X7	T08
ST 8654	X	✓	26	3	30	250	25	APKT 11T3	M2,5X7	T08
ST 11496	X	✓	32	4	70	200	32	APKT 11T3	M2,5X7	T08

## ZCC APKT 0702

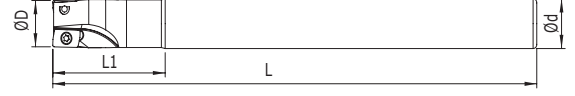

Kesici Uç Uyumluluğu Insert Suitability			Stok Stock	Takım Ölçüleri / Dimension (mm)					Uç Insert	Vida Screw	Anahtar Torx Key
ZCC APKT 0702				D	Z	L1	L	d			
SİPARİŞ KODU Ordering Code	SİPARİŞ KODU Ordering Code Inter Cooland										
ST 8377	X	✓	10	2	30	130	10	APKT 0702	M1,8X4	T06	
ST 12226	X	✓	10	2	30	130	9	APKT 0702	M1,8X4	T06	
ST 8378	X	✓	12	2	30	130	10	APKT 0702	M1,8X4	T06	
ST 12889	X	✓	12	2	30	150	10	APKT 0702	M1,8X4	T06	
ST 8379	X	✓	12	2	30	130	12	APKT 0702	M1,8X4	T06	
ST 12891	X	✓	12	2	30	150	12	APKT 0702	M1,8X4	T06	
ST 14205	X	✓	13	2	30	130	12	APKT 0702	M1,8X4	T06	
ST 8380	X	✓	14	3	30	130	12	APKT 0702	M1,8X4	T06	
ST 12892	X	✓	14	2	30	150	12	APKT 0702	M1,8X4	T06	

## ZCC ANGX 1105

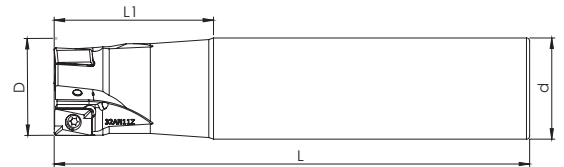

Kesici Uç Uyumluluğu Insert Suitability			Stok Stock	Takım Ölçüleri / Dimension (mm)					Uç Insert	Vida Screw	Anahtar Torx Key
ZCC ANGX 1105				D	Z	L1	L	d			
SİPARİŞ KODU Ordering Code	SİPARİŞ KODU Ordering Code Inter Cooland										
X	ST 8343	✓	25	2	50	150	25	ANGX 1105	M3X8	T10	
X	ST 8344	✓	32	3	50	150	32	ANGX 1105	M3X8	T10	
X	ST 8345	✓	40	4	35	150	32	ANGX 1105	M3X8	T10	

**ZCC LNKT 0804**

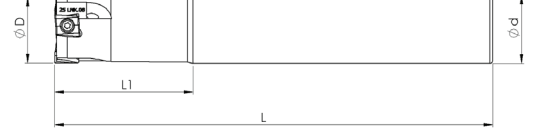

Kesici Uç Uyumluluğu Insert Suitability		Stok Stock	Takım Ölçüleri / Dimension (mm)					Uç Insert	Vida Screw	Anahtar Torx Key
ZCC LNKT 0804			D	Z	L1	L	d			
SİPARİŞ KODU Ordering Code	SİPARİŞ KODU Ordering Code Inter Coolant									
X	ST 11454	✓	20	2	50	160	20	LNKT 0804	M3X8	T10
X	ST 16534	✓	21	2	50	160	20	LNKT 0804	M3X8	T10
X	ST 11455	✓	25	3	50	160	25	LNKT 0804	M3X8	T10
X	ST 11456	✓	32	4	35	160	32	LNKT 0804	M3X8	T10

**ZCC WNHU 0604**



Kesici Uç Uyumluluğu Insert Suitability		Stok Stock	Takım Ölçüleri / Dimension (mm)					Uç Insert	Vida Screw	Anahtar Torx Key
ZCC WNHU 0604			D	Z	L1	L	d			
SİPARİŞ KODU Ordering Code	SİPARİŞ KODU Ordering Code Inter Coolant									
X	ST 9325	✓	25	2	50	160	25	WNHU 0604	M3X8	T10
X	ST 9326	✓	26	2	30	200	25	WNHU 0604	M3X8	T10
X	ST 9327	✓	32	3	50	160	32	WNHU 0604	M3X8	T10

## WLTR ADMT 1204

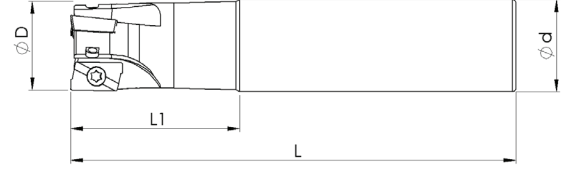

Kesici Uç Uyumluluğu Insert Suitability		Stok Stock	Takım Ölçüleri / Dimension (mm)					Uç Insert	Vida Screw	Anahtar Torx Key
WLTR ADMT 1204			D	Z	L1	L	d			
SIPARIŞ KODU Ordering Code	SIPARIŞ KODU Ordering Code Inter Coolant									
ST 8329	ST 12385	✓	20	2	40	120	20	ADMT 1204	M3X9	T10
ST 8330	X	✓	20	2	50	150	20	ADMT 1204	M3X9	T10
ST 8331	ST 12386	✓	25	3	40	120	25	ADMT 1204	M3X9	T10
ST 8332	X	✓	25	3	50	150	25	ADMT 1204	M3X9	T10
ST 8333	X	✓	30	3	30	120	25	ADMT 1204	M3X9	T10
ST 8334	X	✓	30	3	30	150	25	ADMT 1204	M3X9	T10
ST 8335	ST 12384	✓	32	4	50	150	32	ADMT 1204	M3X9	T10
ST 8336	X	✓	40	4	40	120	32	ADMT 1204	M3X9	T10
ST 8337	X	✓	40	4	40	150	32	ADMT 1204	M3X9	T10

## WLTR ADMT 10T3

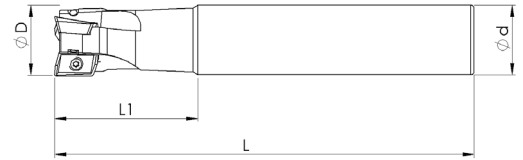

Kesici Uç Uyumluluğu Insert Suitability		Stok Stock	Takım Ölçüleri / Dimension (mm)					Uç Insert	Vida Screw	Anahtar Torx Key
WLTR ADMT 10T3			D	Z	L1	L	d			
SIPARIŞ KODU Ordering Code	SIPARIŞ KODU Ordering Code Inter Coolant									
ST 8327	X	✓	20	3	40	120	20	ADMT 10T3	M2,5X6	T08
ST 8328	X	✓	25	3	40	120	25	ADMT 10T3	M2,5X6	T08

**WLTR ADMT 0803**

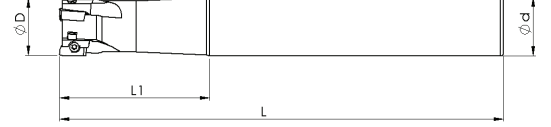

Kesici Uç Uyumluluğu Insert Suitability		Stok Stock	Takım Ölçüleri / Dimension (mm)					Uç Insert	Vida Screw	Anahtar Torx Key
WLTR ADMT 0803			D	Z	L1	L	d			
SİPARİŞ KODU Ordering Code	SİPARİŞ KODU Ordering Code Inter Coolant									
ST 8320	ST 12375	✓	16	2	50	150	16	ADMT 0803	M2,5X6	T08
ST 8321	X	✓	20	2	30	200	16	ADMT 0803	M2,5X6	T08
ST 8322	X	✓	20	3	50	150	20	ADMT 0803	M2,5X6	T08
ST 8323	X	✓	20	3	60	200	20	ADMT 0803	M2,5X6	T08
ST 8324	X	✓	26	3	30	150	25	ADMT 0803	M2,5X6	T08
ST 8325	X	✓	26	3	30	200	25	ADMT 0803	M2,5X6	T08

**WLTR AP.. 0903**

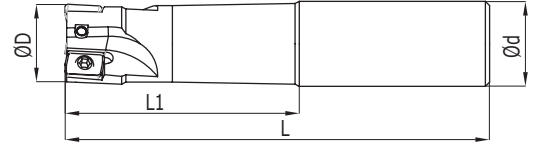

Kesici Uç Uyumluluğu Insert Suitability		Stok Stock	Takım Ölçüleri / Dimension (mm)					Uç Insert	Vida Screw	Anahtar Torx Key
WLTR AP.. 0903			D	Z	L1	L	d			
SİPARİŞ KODU Ordering Code	SİPARİŞ KODU Ordering Code Inter Coolant									
ST 8383	X	✓	16	2	40	130	16	AP.. 0903	M2,5X6	T08
ST 8384	X	✓	16	2	50	150	16	AP.. 0903	M2,5X6	T08
ST 8385	X	✓	16	2	60	200	16	AP.. 0903	M2,5X6	T08
ST 8386	X	✓	20	3	40	120	20	AP.. 0903	M2,5X6	T08

## WLTR LNHU 0904

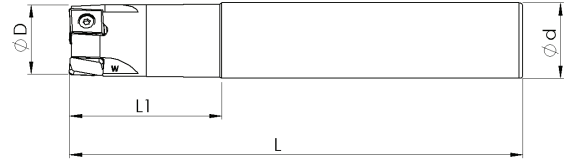

Kesici Uç Uyumluluğu Insert Suitability		Stok Stock	Takım Ölçüleri / Dimension (mm)					Uç Insert	Vida Screw	Anahtar Torx Key
WLTR LNHU 0904			D	Z	L1	L	d			
SİPARİŞ KODU Ordering Code	SİPARİŞ KODU Ordering Code Inter Coolant									
X	ST 8982	✓	20	3	40	120	20	LNHU 0904	M3X10	T10
X	ST 8983	✓	20	3	50	150	20	LNHU 0904	M3X10	T10
X	ST 8984	✓	25	4	40	120	25	LNHU 0904	M3X10	T10
X	ST 8985	✓	25	4	50	150	25	LNHU 0904	M3X10	T10
X	ST 8986	✓	32	5	40	120	32	LNHU 0904	M3X10	T10

## WLTR LNHU 1306



Kesici Uç Uyumluluğu Insert Suitability		Stok Stock	Takım Ölçüleri / Dimension (mm)					Uç Insert	Vida Screw	Anahtar Torx Key
WLTR LNHU 1306			D	Z	L1	L	d			
SİPARİŞ KODU Ordering Code	SİPARİŞ KODU Ordering Code Inter Coolant									
X	ST 8987	✓	30	3	40	150	25	LNHU 1306	M4X9	T15
X	ST 8989	✓	40	4	40	150	32	LNHU 1306	M4X9	T15
X	ST 8990	✓	40	4	60	200	40	LNHU 1306	M4X9	T15

### SMTM AXMT 0602

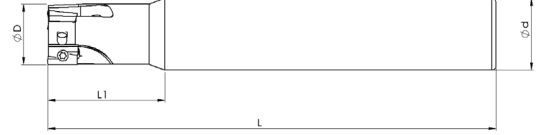

Kesici Uç Uyumluluğu Insert Suitability		Stok Stock	Takım Ölçüleri / Dimension (mm)					Uç Insert	Vida Screw	Anahtar Torx Key
SMTM AXMT 0602			D	Z	L1	L	d			
SİPARİŞ KODU Ordering Code	SİPARİŞ KODU Ordering Code Inter Coolant									
ST 8741	x	✓	10	2	15	75	10	AXMT 0602	M3X6	T10
ST 8743	x	✓	12	2	20	120	12	AXMT 0602	M3X6	T10
ST 8745	x	✓	12	3	20	90	12	AXMT 0602	M3X6	T10
ST 8747	x	✓	14	3	30	100	16	AXMT 0602	M3X6	T10

### AXMT 1235 SMTM



90°

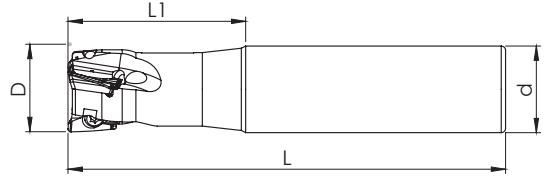

Kesici Uç Uyumluluğu Insert Suitability		Stok Stock	Takım Ölçüleri / Dimension (mm)					Uç Insert	Vida Screw	Anahtar Torx Key
AXMT 1235 SMTM			D	Z	L1	L	d			
SİPARİŞ KODU Ordering Code	SİPARİŞ KODU Ordering Code Inter Coolant									
x	ST 8748	✓	12	1	30	100	12	AXMT 1235	M1,8X4	T6
x	ST 8749	✓	14	1	30	100	12	AXMT 1235	M1,8X4	T6
x	ST 8750	✓	16	2	30	100	16	AXMT 1235	M1,8X4	T6
x	ST 8751	✓	18	2	30	100	16	AXMT 1235	M1,8X4	T6
x	ST 8752	✓	20	3	40	100	20	AXMT 1235	M1,8X4	T6

### PLBT APKT 1003

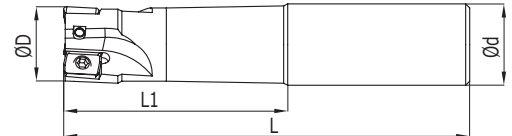

Kesici Uç Uyumluluğu Insert Suitability		Stok Stock	Takım Ölçüleri / Dimension (mm)					Uç Insert	Vida Screw	Anahtar Torx Key
PLBT APKT 1003			D	Z	L1	L	d			
SİPARİŞ KODU Ordering Code	SİPARİŞ KODU Ordering Code Inter Coolant									
ST 8618	x	✓	16	2	40	120	16	APKT 1003	M2,5X6	T08
ST 8621	x	✓	16	2	50	150	150	APKT 1003	M2,5X6	T08
ST 8624	x	✓	20	3	40	120	120	APKT 1003	M2,5X6	T08
ST 8627	x	✓	20	3	50	150	150	APKT 1003	M2,5X6	T08
ST 8629	x	✓	25	3	40	120	120	APKT 1003	M2,5X7	T08
ST 8631	x	✓	25	3	50	150	150	APKT 1003	M2,5X7	T08

## PLBT XPET 0602



Kesici Uç Uyumluluğu Insert Suitability		Stok Stock	Takım Ölçüleri / Dimension (mm)					Uç Insert	Vida Screw	Anahtar Torx Key
PLBT XPET 0602			D	Z	L1	L	d			
SİPARİŞ KODU Ordering Code	SİPARİŞ KODU Ordering Code Inter Coolant									
ST 9407	X	✓	8	1	22	100	8	XPET 0602	M1,8X4	T06
ST 9408	X	✓	8	1	25	120	8	XPET 0602	M1,8X4	T06
ST 9409	X	✓	10	2	22	120	9	XPET 0602	M1,8X4	T06
ST 9410	X	✓	10	2	22	100	10	XPET 0602	M1,8X4	T06
ST 9411	X	✓	12	3	22	100	12	XPET 0602	M1,8X4	T06
ST 9412	X	✓	12	3	22	100	11	XPET 0602	M1,8X4	T06
ST 9413	X	✓	12	3	22	120	12	XPET 0602	M1,8X4	T06
ST 9414	X	✓	14	3	18	140	12	XPET 0602	M1,8X4	T06
ST 9415	X	✓	16	4	20	160	12	XPET 0602	M1,8X4	T06

## I LNMT 0804

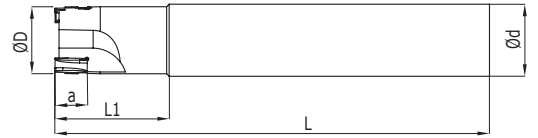

Kesici Uç Uyumluluğu Insert Suitability		Stok Stock	Takım Ölçüleri / Dimension (mm)					Uç Insert	Vida Screw	Anahtar Torx Key
I LNMT 0804			D	Z	L1	L	d			
SİPARİŞ KODU Ordering Code	SİPARİŞ KODU Ordering Code Inter Coolant									
ST 8967	X	✓	16	2	40	120	16	LNMT 0804	M2,5X6	T08
ST 8968	X	✓	18	2	30	120	20	LNMT 0804	M2,5X6	T08
ST 8969	X	✓	20	3	40	120	20	LNMT 0804	M2,5X6	T08
ST 8970	X	✓	25	4	50	150	25	LNMT 0804	M2,5X7	T08
ST 8972	X	✓	30	4	30	150	25	LNMT 0804	M2,5X7	T08
ST 11315	X	✓	32	4	60	200	32	LNMT 0804	M2,5X7	T08

**I ANKX 1205**

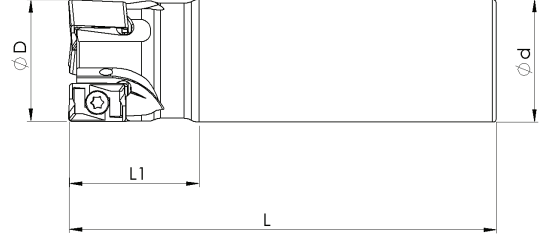

Kesici Uç Uyumluluğu Insert Suitability		Stok Stock	Takım Ölçüleri / Dimension (mm)					Uç İnsert	Vida Screw	Anahtar Torx Key
I ANKX 1205			D	Z	L1	L	d			
X	ST 8354	✓	30	3	30	120	25	ANKX 1205	M4X11	T15
X	ST 8353	✓	30	3	30	150	25	ANKX 1205	M4X11	T15
X	ST 12883	✓	32	3	30	200	25	ANKX 1205	M4X11	T15
ST 8358	X	✓	30	3	40	110	30	ANKX 1205	M4X11	T15
X	ST 8356	✓	35	3	40	120	32	ANKX 1205	M4X11	T15
X	ST 8357	✓	35	3	40	150	32	ANKX 1205	M4X11	T15

**I TPKT 1003**

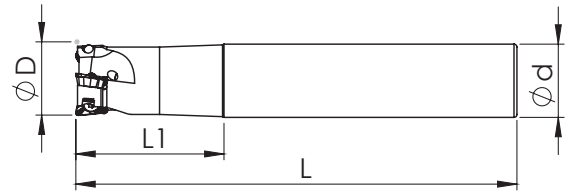

Kesici Uç Uyumluluğu Insert Suitability		Stok Stock	Takım Ölçüleri / Dimension (mm)					Uç İnsert	Vida Screw	Anahtar Torx Key
I TPKT 1003			D	Z	L1	L	d			
X	ST 9309	✓	25	3	40	120	25	TPKT 1003	M3X8	T10
X	ST 9310	✓	25	3	50	150	25	TPKT 1003	M3X8	T10
X	ST 9312	✓	32	4	50	150	32	TPKT 1003	M3X8	T10

## I ADKT 1505

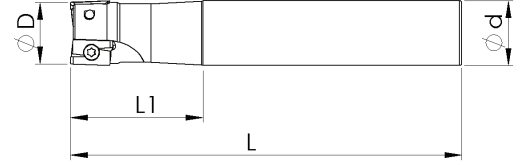

Kesici Uç Uyumluluğu Insert Suitability		Stok Stock	Takım Ölçüleri / Dimension (mm)					Uç Insert	Vida Screw	Anahtar Torx Key
I ADKT 1505			D	Z	L1	L	d			
SİPARİŞ KODU Ordering Code	SİPARİŞ KODU Ordering Code Inter Coolant									
X	ST 11659	✓	25	2	50	150	25	ADKT 1505	M4X11	T15
X	ST 11660	✓	32	3	50	150	32	ADKT 1505	M4X11	T15
X	ST 11661	✓	40	4	40	150	32	ADKT 1505	M4X11	T15

## I ANKX 0904

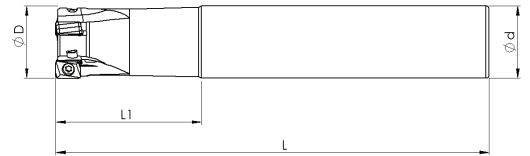

Kesici Uç Uyumluluğu Insert Suitability		Stok Stock	Takım Ölçüleri / Dimension (mm)					Uç Insert	Vida Screw	Anahtar Torx Key
I ANKX 0904			D	Z	L1	L	d			
SİPARİŞ KODU Ordering Code	SİPARİŞ KODU Ordering Code Inter Coolant									
X	ST 11662	✓	16	2	50	150	16	ANKX 0904	M3X8	T10
X	ST 11663	✓	20	2	50	150	20	ANKX 0904	M3X8	T10
X	ST 12664	✓	20	3	50	150	20	ANKX 0904	M3X8	T10
X	ST 12663	✓	25	3	50	150	25	ANKX 0904	M3X8	T10
X	ST 12635	✓	32	4	50	150	32	ANKX 0904	M3X8	T10

**I TCKT 0703**

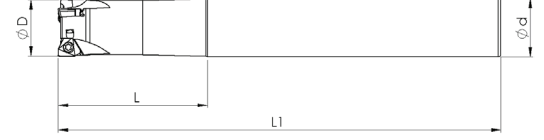

Kesici Uç Uyumluluğu Insert Suitability		Stok Stock	Takım Ölçüleri / Dimension (mm)					Uç Insert	Vida Screw	Anahtar Torx Key
I TCKT 0703			D	Z	L1	L	d			
SIPARIŞ KODU Ordering Code	SIPARIŞ KODU Ordering Code Inter Coolant									
X	ST 11665	✓	16	2	50	150	16	TCKT 0703	M2,5X7	T08
X	ST 11666	✓	20	2	50	150	20	TCKT 0703	M2,5X7	T08

**KNMTL LNGU 1104**

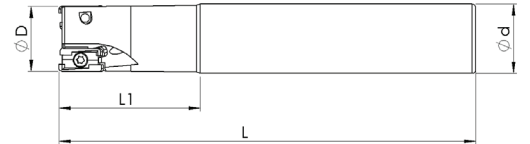

Kesici Uç Uyumluluğu Insert Suitability		Stok Stock	Takım Ölçüleri / Dimension (mm)					Uç Insert	Vida Screw	Anahtar Torx Key
KNMTL LNGU 1104			D	Z	L1	L	d			
SIPARIŞ KODU Ordering Code	SIPARIŞ KODU Ordering Code Inter Coolant									
X	ST 8974	✓	16	2	40	120	16	LNGU 1104	M3X8	T10
X	ST 11383	✓	16	2	50	150	16	LNGU 1104	M3X8	T10
X	ST 8975	✓	20	2	40	120	20	LNGU 1104	M3X8	T10
X	ST 11384	✓	20	2	50	150	20	LNGU 1104	M3X8	T10
X	ST 8976	✓	25	3	40	120	25	LNGU 1104	M3X8	T10
X	ST 11362	✓	25	3	50	150	25	LNGU 1104	M3X8	T10

## KNMTL EDPT 1404

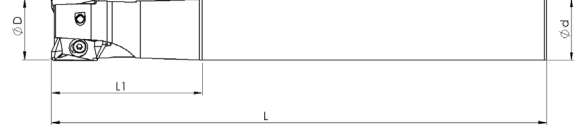

Kesici Uç Uyumluluğu Insert Suitability		Stok Stock	Takım Ölçüleri / Dimension (mm)					Uç Insert	Vida Screw	Anahtar Torx Key
SIPARIŞ KODU Ordering Code	SIPARIŞ KODU Ordering Code Inter Coolant		D	Z	L1	L	d			
KNMTL EDPT 1404										
ST 8947	X	✓	20	2	40	120	20	EDPT 1404	M3X9	T10
ST 8948	X	✓	20	2	50	150	20	EDPT 1404	M3X9	T10
ST 8949	X	✓	25	3	40	120	25	EDPT 1404	M3X9	T10
ST 8950	X	✓	25	3	50	150	25	EDPT 1404	M3X9	T10

## KNMTL EDPT 10T3 - 1805

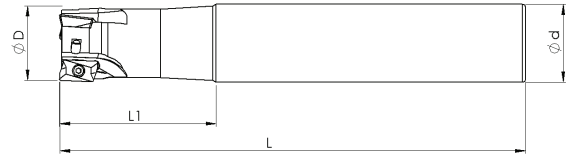

Kesici Uç Uyumluluğu Insert Suitability		Stok Stock	Takım Ölçüleri / Dimension (mm)					Uç Insert	Vida Screw	Anahtar Torx Key
SIPARIŞ KODU Ordering Code	SIPARIŞ KODU Ordering Code Inter Coolant		D	Z	L1	L	d			
KNMTL EDPT 10T3 - 1805										
ST 8944	X	✓	16	2	30	120	14	EDPT 10T3	M2,5X6	T08
ST 11572	X	✓	16	2	40	120	16	EDPT 10T3	M2,5X6	T08
ST 8938	X	✓	16	2	45	150	16	EDPT 10T3	M2,5X6	T08
ST 8942	X	✓	17	2	30	150	16	EDPT 10T3	M2,5X6	T08
ST 8945	X	✓	17	2	30	200	16	EDPT 10T3	M2,5X6	T08
ST 8939	X	✓	18	2	30	150	16	EDPT 10T3	M2,5X6	T08
ST 8940	X	✓	20	3	50	150	20	EDPT 10T3	M2,5X6	T08
ST 8943	X	✓	21	3	50	150	20	EDPT 10T3	M2,5X6	T08
ST 11590	X	✓	22	3	30	150	20	EDPT 10T3	M2,5X6	T08
ST 8946	X	✓	22	3	30	200	20	EDPT 10T3	M2,5X6	T08
ST 8941	X	✓	25	3	50	150	25	EDPT 10T3	M2,5X6	T08
ST 8951	X	✓	25	2	50	200	25	EDPT 1805	M3,5X8	T15
ST 8952	X	✓	32	3	50	200	32	EDPT 1805	M3,5X8	T15

**KRLY LNMX 1006**

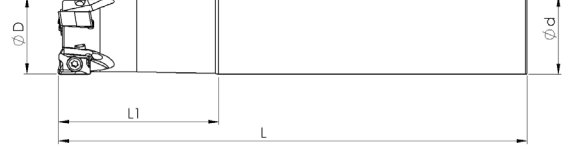

Kesici Uç Uyumluluğu Insert Suitability		Stok Stock	Takım Ölçüleri / Dimension (mm)					Uç Insert	Vida Screw	Anahtar Torx Key
KRLY LNMX 1006			D	Z	L1	L	d			
SİPARİŞ KODU Ordering Code	SİPARİŞ KODU Ordering Code Inter Cooland									
X	ST 9007	✓	16	1	35	90	16	LNMX 1006	M3X8	T10
X	ST 9009	✓	18	2	30	120	16	LNMX 1006	M3X8	T10
X	ST 9011	✓	20	2	35	100	20	LNMX 1006	M3X8	T10
X	ST 9012	✓	20	2	50	150	20	LNMX 1006	M3X8	T10
X	ST 9014	✓	25	2	35	115	25	LNMX 1006	M3X8	T10
X	ST 9015	✓	25	3	35	115	25	LNMX 1006	M3X8	T10
X	ST 9016	✓	25	3	50	150	25	LNMX 1006	M3X8	T10
X	ST 12846	✓	26	3	30	200	25	LNMX 1006	M3X8	T10
X	ST 9018	✓	32	4	40	125	32	LNMX 1006	M3X8	T10
X	ST 12993	✓	32	4	50	150	32	LNMX 1006	M3X8	T10
X	ST 11582	✓	32	4	60	200	32	LNMX 1006	M3X8	T10
X	ST 9019	✓	40	4	40	130	32	LNMX 1006	M3X8	T10
X	ST 9020	✓	40	5	40	130	32	LNMX 1006	M3X8	T10

**KRLY XNKT 0604 - 0805**



Kesici Uç Uyumluluğu Insert Suitability		Stok Stock	Takım Ölçüleri / Dimension (mm)					Uç Insert	Vida Screw	Anahtar Torx Key
KRLY XNKT 0604 - 0805			D	Z	L1	L	d			
SİPARİŞ KODU Ordering Code	SİPARİŞ KODU Ordering Code Inter Cooland									
X	ST 9362	✓	18	2	30	150	20	XNKT 0604	M3X8	T10
X	ST 9363	✓	20	2	30	150	20	XNKT 0604	M3X8	T10
X	ST 13034	✓	21	2	30	150	20	XNKT 0604	M3X8	T10
X	ST 9368	✓	32	3	50	150	32	XNKT 0604	M3X8	T10
X	ST 9364	✓	22	2	30	150	20	XNKT 0604	M3X8	T10
X	ST 9365	✓	25	3	50	150	25	XNKT 0604	M3X8	T10
X	ST 11203	✓	25	3	60	200	25	XNKT 0604	M3X8	T10
X	ST 9366	✓	26	4	30	150	25	XNKT 0604	M3X8	T10
X	ST 11373	✓	26	3	30	200	25	XNKT 0604	M3X8	T10
X	ST 9369	✓	32	3	50	150	32	XNKT 0604	M3X8	T10
X	ST 9367	✓	32	4	50	150	32	XNKT 0805	M4X10	T15
X	ST 12667	✓	32	3	60	200	32	XNKT 0805	M4X10	T15
X	ST 12669	✓	40	4	40	200	32	XNKT 0805	M4X10	T15
X	ST 9370	✓	42	4	35	150	32	XNKT 0805	M4X10	T15

## KRLY APMT 11T3

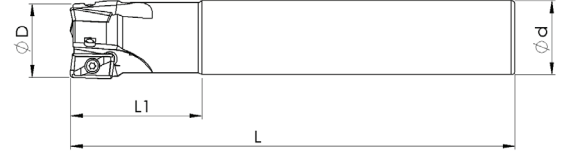

Kesici Uç Uyumluluğu Insert Suitability		Stok Stock	Takım Ölçüleri / Dimension (mm)					Uç Insert	Vida Screw	Anahtar Torx Key
KRLY APMT 11T3			D	Z	L1	L	d			
SIPARIŞ KODU Ordering Code	SIPARIŞ KODU Ordering Code Inter Coolant									
ST 11508	X	✓	16	2	40	120	16	APMT 11T3	M2,5X6	T08
ST 11509	X	✓	16	2	50	150	16	APMT 11T3	M2,5X6	T08
ST 11510	X	✓	16	2	60	200	16	APMT 11T3	M2,5X6	T08
ST 11511	X	✓	17	2	30	120	16	APMT 11T3	M2,5X6	T08
ST 12774	X	✓	17	2	30	150	16	APMT 11T3	M2,5X6	T08
ST 12482	X	✓	18	2	30	120	16	APMT 11T3	M2,5X6	T08
ST 11512	X	✓	20	3	40	120	20	APMT 11T3	M2,5X7	T08
ST 12613	X	✓	20	3	50	150	20	APMT 11T3	M2,5X7	T08
ST 11667	X	✓	20	3	60	200	20	APMT 11T3	M2,5X7	T08
ST 11513	X	✓	21	3	30	120	20	APMT 11T3	M2,5X7	T08
ST 12775	X	✓	21	3	30	150	20	APMT 11T3	M2,5X7	T08
ST 11668	X	✓	21	3	30	200	20	APMT 11T3	M2,5X7	T08
ST 11514	X	✓	22	3	30	120	20	APMT 11T3	M2,5X7	T08
ST 13074	X	✓	22	3	30	150	20	APMT 11T3	M2,5X7	T08
ST 11669	X	✓	25	3	50	150	25	APMT 11T3	M2,5X7	T08

## SNDVK R390 11T3

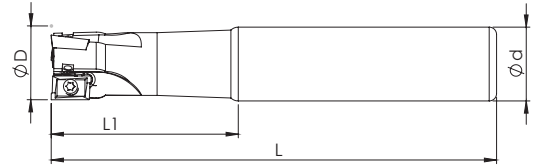

Kesici Uç Uyumluluğu Insert Suitability		Stok Stock	Takım Ölçüleri / Dimension (mm)					Uç Insert	Vida Screw	Anahtar Torx Key
SNDVK R390 11T3			D	Z	L1	L	d			
SIPARIŞ KODU Ordering Code	SIPARIŞ KODU Ordering Code Inter Coolant									
ST 9148	X	✓	16	2	35	100	16	R390 11T3	M2,5X6	T08
ST 9144	ST 12381	✓	16	2	44	150	16	R390 11T3	M2,5X6	T08
ST 9147	X	✓	20	3	40	100	20	R390 11T3	M2,5X6	T08
ST 9145	ST 12382	✓	20	3	50	150	20	R390 11T3	M2,5X6	T08
ST 9149	X	✓	25	3	35	100	25	R390 11T3	M2,5X6	T08
ST 9146	ST 12383	✓	25	3	50	150	25	R390 11T3	M2,5X6	T08
ST 16862	X	✓	32	4	50	150	32	R390 11T3	M2,5X6	T08

**SNDVK R390 1704**



Kesici Uç Uyumluluğu Insert Suitability		Stok Stock	Takım Ölçüleri / Dimension (mm)					Uç Insert	Vida Screw	Anahtar Torx Key
SIPARIŞ KODU Ordering Code	SIPARIŞ KODU Ordering Code Inter Coolant		D	Z	L1	L	d			
SNDVK R390 1704										
ST 9150	ST 12377	✓	25	2	50	150	25	R390 1704	M3,5X11	T15
ST 11676	ST 12376	✓	32	3	50	150	32	R390 1704	M3,5X11	T15
ST 12053	X	✓	40	4	40	150	25	R390 1704	M3,5X11	T15

**VNDRT ANHG 1005**

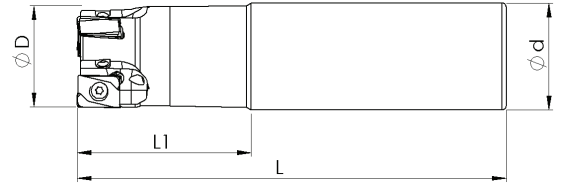
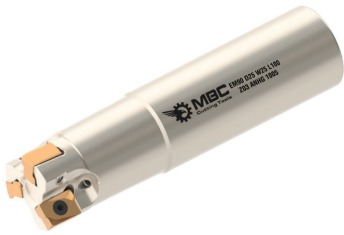

Kesici Uç Uyumluluğu Insert Suitability		Stok Stock	Takım Ölçüleri / Dimension (mm)					Uç Insert	Vida Screw	Anahtar Torx Key
SIPARIŞ KODU Ordering Code	SIPARIŞ KODU Ordering Code Inter Coolant		D	Z	L1	L	d			
VNDRT ANHG 1005										
X	ST 8346	✓	20	2	35	90	20	ANHG 1005	M3X10	T10
X	ST 8347	✓	20	2	40	120	20	ANHG 1005	M3X10	T10
X	ST 8348	✓	20	2	50	150	20	ANHG 1005	M3X10	T10
X	ST 8349	✓	25	3	35	100	25	ANHG 1005	M3X10	T10
X	ST 8350	✓	25	3	50	150	25	ANHG 1005	M3X10	T10
X	ST 8351	✓	32	3	35	110	32	ANHG 1005	M3X10	T10

## PRMT - VNDRT LNGX 1205

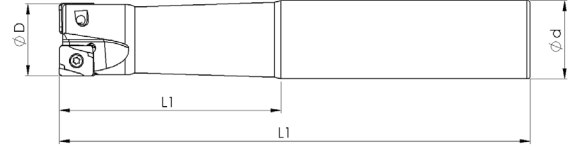

Kesici Uç Uyumluluğu Insert Suitability		Stok Stock	Takım Ölçüleri / Dimension (mm)					Uç Insert	Vida Screw	Anahtar Torx Key
PRMT - VNDRT LNGX 1205	SIPARIŞ KODU Ordering Code		SIPARIŞ KODU Ordering Code	D	Z	L1	L	d		
ST 8978	X	✓	25	3	50	150	25	LNGX 1205	M3,5X10	T15
ST 8979	X	✓	32	3	50	150	32	LNGX 1205	M3,5X10	T15

## PRMT TNGX 1004



Kesici Uç Uyumluluğu Insert Suitability		Stok Stock	Takım Ölçüleri / Dimension (mm)					Uç Insert	Vida Screw	Anahtar Torx Key
PRMT TNGX 1004	SIPARIŞ KODU Ordering Code		SIPARIŞ KODU Ordering Code	D	Z	L1	L	d		
X	ST 9295	✓	18	2	30	150	16	TNGX 1004	M2,5X7	T08
X	ST 9296	✓	21	3	30	150	20	TNGX 1004	M2,5X7	T08
X	ST 9297	✓	26	4	30	150	25	TNGX 1004	M2,5X7	T08
X	ST 9298	✓	26	4	30	200	25	TNGX 1004	M2,5X7	T08
X	ST 9299	✓	33	5	40	150	32	TNGX 1004	M2,5X7	T08
X	ST 9300	✓	33	5	40	200	32	TNGX 1004	M2,5X7	T08

**PRMT ADMX 11T3**

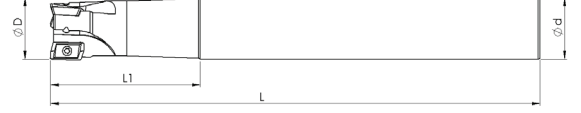

Kesici Uç Uyumluluğu Insert Suitability		Stok Stock	Takım Ölçüleri / Dimension (mm)					Uç Insert	Vida Screw	Anahtar Torx Key
PRMT ADMX 11T3			D	Z	L1	L	d			
SİPARİŞ KODU Ordering Code	SİPARİŞ KODU Ordering Code Inter Coolant									
ST 8338	x	✓	12	1	40	120	12	ADMX 11T3	M2,5X5	T08
ST 8339	ST 12378	✓	16	2	50	150	16	ADMX 11T3	M2,5X6	T08
ST 8340	ST 12379	✓	20	3	50	150	20	ADMX 11T3	M2,5X6	T08
ST 8341	x	✓	25	3	60	200	25	ADMX 11T3	M2,5X7	T08
x	ST 12380	✓	25	4	60	200	25	ADMX 11T3	M2,5X7	T08
ST 8342	x	✓	32	4	60	200	32	ADMX 11T3	M2,5X7	T08

**TT AXMT 0602**

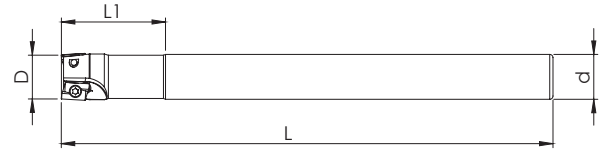

Kesici Uç Uyumluluğu Insert Suitability		Stok Stock	Takım Ölçüleri / Dimension (mm)					Uç Insert	Vida Screw	Anahtar Torx Key
TT AXMT 0602			D	Z	L1	L	d			
SİPARİŞ KODU Ordering Code	SİPARİŞ KODU Ordering Code Inter Coolant									
ST 8742	x	✓	10	2	120	150	9	AXMT 0602	M1,8X4	T06
ST 8744	x	✓	11	2	120	150	10	AXMT 0602	M1,8X4	T06
ST 8746	x	✓	12	2	120	150	11	AXMT 0602	M1,8X4	T06

## TT 4NKT 0402

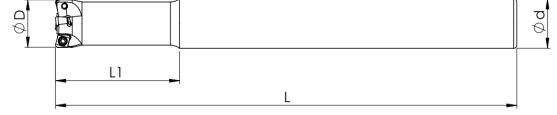

Kesici Uç Uyumluluğu Insert Suitability		Stok Stock	Takım Ölçüleri / Dimension (mm)					Uç Insert	Vida Screw	Anahtar Torx Key
TT 4NKT 0402			D	Z	L1	L	d			
SİPARİŞ KODU Ordering Code	SİPARİŞ KODU Ordering Code Inter Coolant									
ST 12071	X	✓	10	2	30	100	10	4NKT 0402	M1,8X4	T06
ST 12072	X	✓	12	3	35	120	12	4NKT 0402	M1,8X4	T06
ST 11472	X	✓	16	4	40	150	16	4NKT 0402	M1,8X4	T06

## TT 4NKT 0603

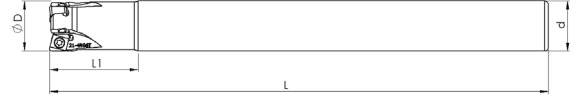

Kesici Uç Uyumluluğu Insert Suitability		Stok Stock	Takım Ölçüleri / Dimension (mm)					Uç Insert	Vida Screw	Anahtar Torx Key
TT 4NKT 0603			D	Z	L1	L	d			
SİPARİŞ KODU Ordering Code	SİPARİŞ KODU Ordering Code Inter Coolant									
ST 8295	X	✓	16	2	40	120	16	4NKT 0603	M3X8	T10
X	ST 11575	✓	16	2	50	150	16	4NKT 0603	M3X8	T10
ST 8297	ST 13000	✓	17	2	30	150	16	4NKT 0603	M3X8	T10
X	ST 8298	✓	17	2	30	200	16	4NKT 0603	M3X8	T10
X	ST 12855	✓	18	2	30	150	16	4NKT 0603	M3X8	T10
X	ST 8304	✓	20	3	40	120	20	4NKT 0603	M3X8	T10
X	ST 11576	✓	20	3	40	160	20	4NKT 0603	M3X8	T10
X	ST 12971	✓	21	3	30	160	20	4NKT 0603	M3X8	T10
X	ST 8300	✓	21	3	30	200	20	4NKT 0603	M3X8	T10
X	ST 12856	✓	22	3	30	160	20	4NKT 0603	M3X8	T10
X	ST 16892	✓	25	3	40	120	25	4NKT 0603	M3X8	T10
X	ST 11577	✓	25	3	40	150	25	4NKT 0603	M3X8	T10
X	ST 8301	✓	25	3	60	200	25	4NKT 0603	M3X8	T10
X	ST 13035	✓	26	3	30	150	25	4NKT 0603	M3X8	T10
X	ST 8302	✓	26	3	30	200	25	4NKT 0603	M3X8	T10
X	ST 13021	✓	32	4	40	150	32	4NKT 0603	M3X8	T10
X	ST 12761	✓	33	4	40	200	32	4NKT 0603	M3X8	T10

**TT 6NGU 0604**

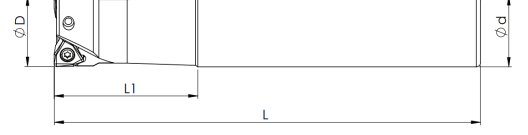

Kesici Uç Uyumluluğu Insert Suitability		Stok Stock	Takım Ölçüleri / Dimension (mm)					Uç Insert	Vida Screw	Anahtar Torx Key
TT 6NGU 0604			D	Z	L1	L	d			
SİPARİŞ KODU Ordering Code	SİPARİŞ KODU Ordering Code Inter Coolant									
x	ST 12408	✓	25	2	50	150	25	6NGU 0604	M3X8	T10
x	ST 11609	✓	32	3	50	150	32	6NGU 0604	M3X8	T10

**TT 2PKT 0503**

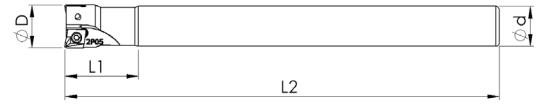

Kesici Uç Uyumluluğu Insert Suitability		Stok Stock	Takım Ölçüleri / Dimension (mm)					Uç Insert	Vida Screw	Anahtar Torx Key
TT 2PKT 0503			D	Z	L1	L	d			
SİPARİŞ KODU Ordering Code	SİPARİŞ KODU Ordering Code Inter Coolant									
ST 8281	x	✓	12	2	20	120	11	2PKT 0503	M2X5	T06
ST 8282	x	✓	12	2	30	120	12	2PKT 0503	M2X5	T06

**TT 3PKT 1004**

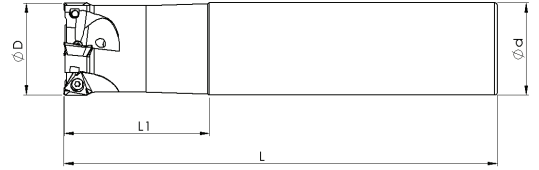

Kesici Uç Uyumluluğu Insert Suitability		Stok Stock	Takım Ölçüleri / Dimension (mm)					Uç Insert	Vida Screw	Anahtar Torx Key
TT 3PKT 1004			D	Z	L1	L	d			
SİPARİŞ KODU Ordering Code	SİPARİŞ KODU Ordering Code Inter Coolant									
X	ST 8284	✓	20	2	50	150	20	3PKT 1004	M2,5X7	T08
X	ST 8285	✓	25	3	50	150	25	3PKT 1004	M2,5X7	T08
X	ST 8286	✓	32	4	50	150	32	3PKT 1004	M2,5X7	T08

**TT 3PKT 1505**

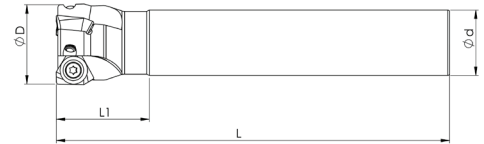

Kesici Uç Uyumluluğu Insert Suitability		Stok Stock	Takım Ölçüleri / Dimension (mm)					Uç Insert	Vida Screw	Anahtar Torx Key
TT 3PKT 1505			D	Z	L1	L	d			
SİPARİŞ KODU Ordering Code	SİPARİŞ KODU Ordering Code Inter Coolant									
X	ST 13083	✓	32	3	30	150	25	3PKT 1505	M4,5X12	T20
X	ST 13084	✓	32	3	60	200	32	3PKT 1505	M4,5X12	T20

**TT APKT 09T3**

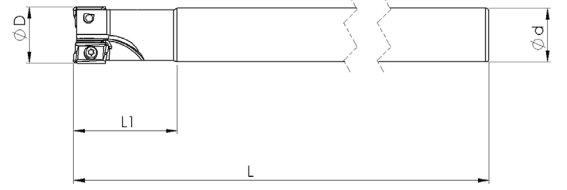

Kesici Uç Uyumluluğu Insert Suitability		Stok Stock	Takım Ölçüleri / Dimension (mm)					Uç Insert	Vida Screw	Anahtar Torx Key
TT APKT 09T3			D	Z	L1	L	d			
SİPARİŞ KODU Ordering Code	SİPARİŞ KODU Ordering Code Inter Coolant									
ST 8612	X	✓	16	2	30	150	15	APKT 09T3	M2,5X7	T08
ST 8613	X	✓	17	2	30	200	16	APKT 09T3	M2,5X7	T08
ST 8614	X	✓	21	3	30	200	20	APKT 09T3	M2,5X7	T08

**WDA XDPT 1104**

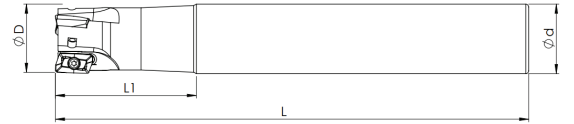

Kesici Uç Uyumluluğu Insert Suitability		Stok Stock	Takım Ölçüleri / Dimension (mm)					Uç Insert	Vida Screw	Anahtar Torx Key
WDA XDPT 1104			D	Z	L1	L	d			
SİPARİŞ KODU Ordering Code	SİPARİŞ KODU Ordering Code Inter Coolant									
X	ST 14335	✓	16	2	35	170	16	XDPT 1104	M2,5X6	T08
X	ST 12627	✓	18	2	35	170	16	XDPT 1104	M2,5X6	T08
X	ST 12471	✓	20	3	50	170	20	XDPT 1104	M2,5X6	T08
X	ST 12628	✓	22	3	35	170	20	XDPT 1104	M2,5X6	T08
X	ST 12472	✓	25	3	50	170	25	XDPT 1104	M2,5X7	T08
X	ST 12473	✓	40	5	35	170	32	XDPT 1104	M2,5X7	T08
X	ST 9361	✓	45	4	40	120	25	XDPT 1104	M2,5X7	T08

## WDA XNGU 1002



Kesici Uç Uyumluluğu Insert Suitability		Stok Stock	Takım Ölçüleri / Dimension (mm)					Uç Insert	Vida Screw	Anahtar Torx Key
WDA XNGU 1002			D	Z	L1	L	d			
SİPARİŞ KODU Ordering Code	SİPARİŞ KODU Ordering Code Inter Cooland									
X	ST 11677	✓	16	2	50	150	16	XNGU 1002	M3X8	T10
X	ST 11678	✓	20	2	50	150	20	XNGU 1002	M3X8	T10
X	ST 11679	✓	25	3	50	150	25	XNGU 1002	M3X8	T10
X	ST 15431	✓	32	4	50	150	32	BOMT 09T3	M2,5X7	T08

## INGRSL BOMT 09T308

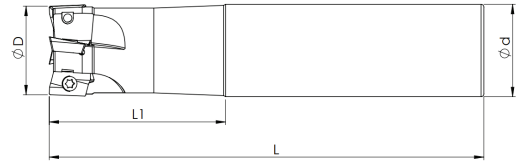

Kesici Uç Uyumluluğu Insert Suitability		Stok Stock	Takım Ölçüleri / Dimension (mm)					Uç Insert	Vida Screw	Anahtar Torx Key
INGRSL BOMT 09T308			D	Z	L1	L	d			
SİPARİŞ KODU Ordering Code	SİPARİŞ KODU Ordering Code Inter Cooland									
ST 12619	X	✓	16	2	40	150	16	BOMT 09T3	M2,5X7	T08
ST 12620	X	✓	16	2	40	150	16	BOMT 09T3	M2,5X7	T08
ST 12621	X	✓	20	3	40	150	20	BOMT 09T3	M2,5X7	T08
ST 12622	X	✓	22	3	40	150	20	BOMT 09T3	M2,5X7	T08
ST 16516	X	✓	25	4	40	150	25	BOMT 09T3	M2,5X7	T08

## INGRSL BOMT 1304

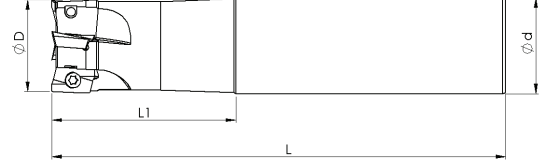

Kesici Uç Uyumluluğu Insert Suitability		Stok Stock	Takım Ölçüleri / Dimension (mm)					Uç Insert	Vida Screw	Anahtar Torx Key
INGRSL BOMT 1304			D	Z	L1	L	d			
SİPARİŞ KODU Ordering Code	SİPARİŞ KODU Ordering Code Inter Coolant									
ST 8819	X	✓	20	2	50	150	20	BOMT 1304	M3,5X8X4.80	T15
ST 8820	X	✓	22	2	30	150	20	BOMT 1304	M3,5X8X4.80	T15
ST 8821	X	✓	25	3	50	150	25	BOMT 1304	M3,5X8X4.80	T15
ST 8822	X	✓	32	4	30	150	25	BOMT 1304	M3,5X8X4.80	T15
ST 8823	X	✓	32	4	50	150	32	BOMT 1304	M3,5X8X4.80	T15

## INGRSL AOMT 1605

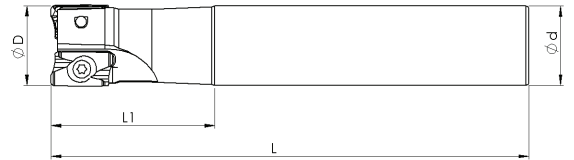

Kesici Uç Uyumluluğu Insert Suitability		Stok Stock	Takım Ölçüleri / Dimension (mm)					Uç Insert	Vida Screw	Anahtar Torx Key
INGRSL AOMT 1605			D	Z	L1	L	d			
SİPARİŞ KODU Ordering Code	SİPARİŞ KODU Ordering Code Inter Coolant									
ST 8370	X	✓	25	2	40	120	25	AOMT 1605	M4X9	T15
ST 8371	X	✓	25	2	50	150	25	AOMT 1605	M4X9	T15
ST 8372	X	✓	25	2	60	200	25	AOMT 1605	M4X9	T15
ST 8373	X	✓	32	3	40	150	25	AOMT 1605	M4X9	T15
ST 8374	X	✓	32	3	50	150	32	AOMT 1605	M4X9	T15

## TNGLY TOMT 0603 - 1004



Kesici Uç Uyumluluğu Insert Suitability		Stok Stock	Takım Ölçüleri / Dimension (mm)					Uç Insert	Vida Screw	Anahtar Torx Key
TNGLY TOMT 0603 - 1004			D	Z	L1	L	d			
SİPARİŞ KODU Ordering Code	SİPARİŞ KODU Ordering Code Inter Coolant									
X	ST 9301	✓	16	2	50	150	16	TOMT 0603	M2,5X6	T08
X	ST 9303	✓	20	3	50	150	20	TOMT 0603	M2,5X6	T08

## KYCR BDMT 0703

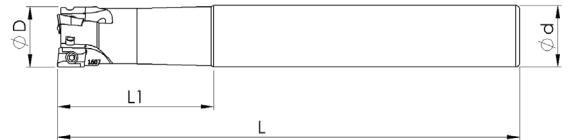

Kesici Uç Uyumluluğu Insert Suitability		Stok Stock	Takım Ölçüleri / Dimension (mm)					Uç Insert	Vida Screw	Anahtar Torx Key
KYCR BDMT 0703			D	Z	L1	L	d			
SİPARİŞ KODU Ordering Code	SİPARİŞ KODU Ordering Code Inter Coolant									
ST 8761	X	✓	10	1	20	100	10	BDMT 0703	M2X5	T06
ST 8762	X	✓	11	2	25	120	10	BDMT 0703	M2X5	T06
ST 8763	X	✓	12	2	25	120	11	BDMT 0703	M2X5	T06
ST 8764	X	✓	12	2	30	120	12	BDMT 0703	M2X5	T06
ST 12666	X	✓	14	3	25	120	12	BDMT 0703	M2X6	T06
ST 8765	X	✓	16	3	40	120	16	BDMT 0703	M2X6	T06

**KYCR BDMT 1704**

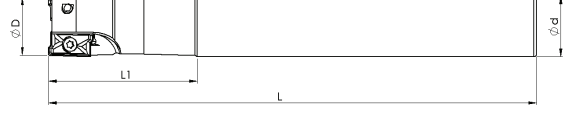

Kesici Uç Uyumluluğu Insert Suitability		Stok Stock	Takım Ölçüleri / Dimension (mm)					Uç Insert	Vida Screw	Anahtar Torx Key
KYCR BDMT 1704			D	Z	L1	L	d			
SİPARİŞ KODU Ordering Code	SİPARİŞ KODU Ordering Code Inter Coolant									
x	ST 8796	✓	25	2	50	160	25	BDMT 1704	M4X8	T15
x	ST 8798	✓	32	3	60	200	32	BDMT 1704	M4X8	T15

**KYCR APKT 1003**

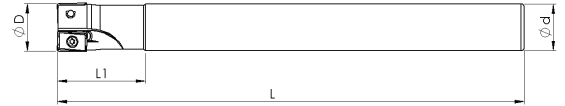

Kesici Uç Uyumluluğu Insert Suitability		Stok Stock	Takım Ölçüleri / Dimension (mm)					Uç Insert	Vida Screw	Anahtar Torx Key
KYCR APKT 1003			D	Z	L1	L	d			
SİPARİŞ KODU Ordering Code	SİPARİŞ KODU Ordering Code Inter Coolant									
x	ST 8617	✓	17	2	30	160	16	APKT 1003	M2,5X6	T08
x	ST 8620	✓	21	3	30	160	20	APKT 1003	M2,5X6	T08
x	ST 8623	✓	25	3	50	160	25	APKT 1003	M2,5X7	T08

## KYCR BDMT 11T3

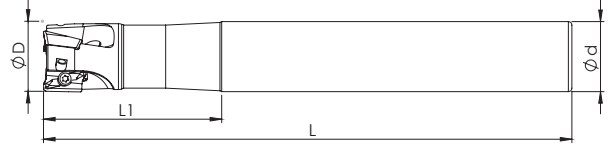

Kesici Uç Uyumluluğu Insert Suitability		Stok Stock	Takım Ölçüleri / Dimension (mm)					Uç Insert	Vida Screw	Anahtar Torx Key
KYCR BDMT 11T3			D	Z	L1	L	d			
SIPARIŞ KODU Ordering Code	SIPARIŞ KODU Ordering Code Inter Coolant									
X	ST 8794	✓	16	2	30	160	15	BDMT 11T3	M2,5X6	T08
X	ST 8766	✓	16	2	50	160	16	BDMT 11T3	M2,5X6	T08
X	ST 8767	✓	16	2	50	180	16	BDMT 11T3	M2,5X6	T08
X	ST 8770	✓	17	2	30	160	16	BDMT 11T3	M2,5X6	T08
X	ST 8772	✓	17	2	30	200	16	BDMT 11T3	M2,5X6	T08
ST 8774	X	✓	17	2	30	260	16	BDMT 11T3	M2,5X6	T08
X	ST 8795	✓	18	2	30	160	16	BDMT 11T3	M2,5X6	T08
X	ST 8775	✓	20	3	35	110	20	BDMT 11T3	M2,5X6	T08
X	ST 12353	✓	20	3	30	120	20	BDMT 11T3	M2,5X6	T08
X	ST 8776	✓	20	3	50	160	20	BDMT 11T3	M2,5X6	T08
X	ST 8777	✓	20	3	50	180	20	BDMT 11T3	M2,5X6	T08
X	ST 8778	✓	20	3	60	200	20	BDMT 11T3	M2,5X6	T08
X	ST 8779	✓	21	3	30	160	20	BDMT 11T3	M2,5X7	T08
X	ST 8780	✓	21	3	30	180	20	BDMT 11T3	M2,5X7	T08
X	ST 8781	✓	21	3	30	200	20	BDMT 11T3	M2,5X7	T08
ST 8782	X	✓	21	3	30	260	20	BDMT 11T3	M2,5X7	T08
X	ST 8783	✓	25	3	50	160	25	BDMT 11T3	M2,5X7	T08
X	ST 8784	✓	25	3	60	200	25	BDMT 11T3	M2,5X7	T08
X	ST 8785	✓	26	4	30	160	25	BDMT 11T3	M2,5X7	T08
X	ST 8786	✓	26	4	30	200	25	BDMT 11T3	M2,5X7	T08
ST 8787	X	✓	26	4	30	260	25	BDMT 11T3	M2,5X7	T08
X	ST 8789	✓	32	4	60	200	32	BDMT 11T3	M2,5X7	T08
X	ST 12563	✓	33	4	30	150	32	BDMT 11T3	M2,5X7	T08
X	ST 8792	✓	33	4	40	200	32	BDMT 11T3	M2,5X7	T08

## KYCR LOMU 1505

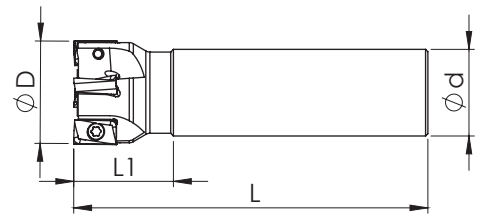

Kesici Uç Uyumluluğu Insert Suitability		Stok Stock	Takım Ölçüleri / Dimension (mm)					Uç Insert	Vida Screw	Anahtar Torx Key
KYCR LOMU 1505			D	Z	L1	L	d			
SIPARIŞ KODU Ordering Code	SIPARIŞ KODU Ordering Code Inter Coolant									
X	ST 12544	✓	28	2	30	160	25	LOMU 1505	M4X8	T15
X	ST 12545	✓	32	3	30	160	25	LOMU 1505	M4X8	T15
X	ST 12546	✓	32	3	50	160	32	LOMU 1505	M4X8	T15

### KYCR WNMU 0504

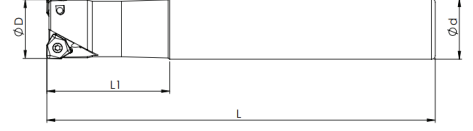

Kesici Uç Uyumluluğu Insert Suitability		Stok Stock	Takım Ölçüleri / Dimension (mm)					Uç Insert	Vida Screw	Anahtar Torx Key
KYCR WNMU 0504			D	Z	L1	L	d			
SİPARİŞ KODU Ordering Code	SİPARİŞ KODU Ordering Code Inter Coolant									
X	ST 11984	✓	22	2	30	160	20	WNMU 0504	M3X8	T10
X	ST 11981	✓	25	2	35	120	25	WNMU 0504	M3X8	T10
X	ST 11982	✓	25	2	50	160	25	WNMU 0504	M3X8	T10
X	ST 11983	✓	26	2	35	160	25	WNMU 0504	M3X8	T10
X	ST 12577	✓	30	3	40	120	25	WNMU 0504	M3X8	T10
X	ST 11986	✓	32	3	50	160	32	WNMU 0504	M3X8	T10
X	ST 11987	✓	32	3	50	200	32	WNMU 0504	M3X8	T10
X	ST 9330	✓	40	3	36	100	20	WNMU 0806	M5X10	T20
X	ST 12953	✓	40	3	40	150	32	WNMU 0806	M5X10	T20
X	ST 9331	✓	40	3	40	160	32	WNMU 0806	M5X10	T20

### KYCR LOMU 1004



Kesici Uç Uyumluluğu Insert Suitability		Stok Stock	Takım Ölçüleri / Dimension (mm)					Uç Insert	Vida Screw	Anahtar Torx Key
KYCR LOMU 1004			D	Z	L1	L	d			
SİPARİŞ KODU Ordering Code	SİPARİŞ KODU Ordering Code Inter Coolant									
X	ST 9054	✓	16	2	45	100	16	LOMU 1004	M3X8	T10
X	ST 9063	✓	16	2	36	150	16	LOMU 1004	M3X8	T10
X	ST 9055	✓	16	2	36	160	16	LOMU 1004	M3X8	T10
X	ST 9056	✓	17	2	36	180	16	LOMU 1004	M3X8	T10
X	ST 9065	✓	20	3	36	110	20	LOMU 1004	M3X8	T10
X	ST 9066	✓	20	3	35	160	20	LOMU 1004	M3X8	T10
X	ST 9060	✓	21	3	50	180	20	LOMU 1004	M3X8	T10
X	ST 13093	✓	21	3	30	200	20	LOMU 1004	M3X8	T10
X	ST 12579	✓	25	3	50	160	25	LOMU 1004	M3X8	T10
X	ST 12580	✓	25	3	60	200	25	LOMU 1004	M3X8	T10
X	ST 11950	✓	26	3	30	160	25	LOMU 1004	M3X8	T10
X	ST 13006	✓	28	4	30	160	25	LOMU 1004	M3X8	T10

## KYCR SOMT 1004



Kesici Uç Uyumluluğu Insert Suitability		Stok Stock	Takım Ölçüleri / Dimension (mm)					Uç Insert	Vida Screw	Anahtar Torx Key
SIPARIŞ KODU Ordering Code	SIPARIŞ KODU Ordering Code Inter Coolant		D	Z	L1	L	d			
X	ST 12062	✓	25	2	50	160	25	SOMT 1004	M4X11	T15
X	ST 12063	✓	26	2	30	160	25	SOMT 1004	M4X11	T15
X	ST 12064	✓	33	3	40	160	32	SOMT 1004	M4X11	T15

## CRTZ XDKT 11T3

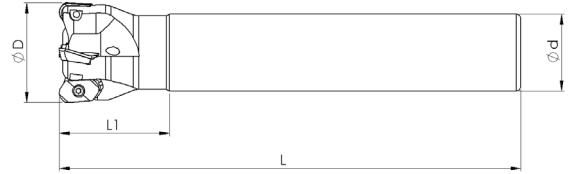

Kesici Uç Uyumluluğu Insert Suitability		Stok Stock	Takım Ölçüleri / Dimension (mm)					Uç Insert	Vida Screw	Anahtar Torx Key
SIPARIŞ KODU Ordering Code	SIPARIŞ KODU Ordering Code Inter Coolant		D	Z	L1	L	d			
ST 9357	X	✓	16	2	30	150	15	XDKT 11T3	M2,5X6	T08
ST 9358	X	✓	20	3	30	150	19	XDKT 11T3	M2,5X6	T08
ST 9359	X	✓	25	3	30	150	24	XDKT 11T3	M2,5X7	T08
ST 9360	X	✓	32	4	40	150	25	XDKT 11T3	M2,5X7	T08

## BHLR APKT 1604

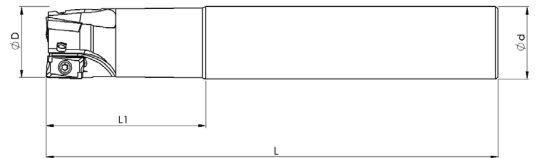

Kesici Uç Uyumluluğu Insert Suitability		Stok Stock	Takım Ölçüleri / Dimension (mm)					Uç Insert	Vida Screw	Anahtar Torx Key
SIPARIŞ KODU Ordering Code	SIPARIŞ KODU Ordering Code Inter Coolant		D	Z	L1	L	d			
ST 11687	X	✓	25	2	50	150	25	APKT 1604	M4X11	T15
ST 11688	X	✓	32	3	50	150	32	APKT 1604	M4X11	T15

**ZCC SDMT 06 - 09**



Kesici Uç Uyumluluğu Insert Suitability		Stok Stock	Takım Ölçüleri / Dimension (mm)					Uç Insert	Vida Screw	Pabuç Clamp	Vida Screw	Anahtar Torx Key
ZCC SDMT 06 - 09			D	Z	L1	L	d					
SİPARİŞ KODU Ordering Code	SİPARİŞ KODU Ordering Code Inter Coolant											
X	ST 9240	✓	16	2	40	150	16	SDMT 06T2	M2,2X5	-	-	T06
X	ST 9241	✓	17	2	25	160	16	SDMT 06T2	M2,2X5	-	-	T06
X	ST 9242	✓	20	2	40	150	20	SDMT 06T2	M2,2X5	-	-	T06
X	ST 9243	✓	20	3	40	150	20	SDMT 06T2	M2,2X5	-	-	T06
X	ST 12369	✓	20	3	40	160	20	SDMT 06T2	M2,2X5	-	-	T06
X	ST 9244	✓	21	3	25	200	20	SDMT 06T2	M2,2X5	-	-	T06
X	ST 9260	✓	22	2	25	170	20	SDMT 09T3	M3,5X8	CK14	M3,5X10	T15
X	ST 9264	✓	25	2	40	160	25	SDMT 09T3	M3,5X8	CK14	M3,5X10	T15
X	ST 11525	✓	25	3	50	160	25	SDMT 09T3	M3,5X8	CK14	M3,5X10	T15
X	ST 11524	✓	25	2	60	200	25	SDMT 09T3	M3,5X8	CK14	M3,5X10	T15
X	ST 12913	✓	25	3	60	200	25	SDMT 09T3	M3,5X8	CK14	M3,5X10	T15
X	ST 11939	✓	26	2	30	160	25	SDMT 09T3	M3,5X8	CK14	M3,5X10	T15
X	ST 12769	✓	26	3	30	160	25	SDMT 09T3	M3,5X8	CK14	M3,5X10	T15
X	ST 9266	✓	26	2	30	200	25	SDMT 09T3	M3,5X8	CK14	M3,5X10	T15
X	ST 12878	✓	26	3	30	160	25	SDMT 09T3	M3,5X8	CK14	M3,5X10	T15
X	ST 9268	✓	32	3	30	150	25	SDMT 09T3	M3,5X8	CK14	M3,5X10	T15
X	ST 9269	✓	32	3	50	150	32	SDMT 09T3	M3,5X8	CK14	M3,5X10	T15
X	ST 9271	✓	32	3	50	160	32	SDMT 09T3	M3,5X8	CK14	M3,5X10	T15
X	ST 11519	✓	32	3	60	200	32	SDMT 09T3	M3,5X8	CK14	M3,5X10	T15
X	ST 11471	✓	33	3	40	160	32	SDMT 09T3	M3,5X8	CK14	M3,5X10	T15
X	ST 9273	✓	33	3	30	200	32	SDMT 09T3	M3,5X8	CK14	M3,5X10	T15
X	ST 12879	✓	33	3	30	250	32	SDMT 09T3	M3,5X8	CK14	M3,5X10	T15
X	ST 12902	✓	35	4	30	160	32	SDMT 09T3	M3,5X8	CK14	M3,5X10	T15
X	ST 11324	✓	42	4	40	160	32	SDMT 09T3	M3,5X8	CK14	M3,5X10	T15

**PLBT SP.. 08T3**

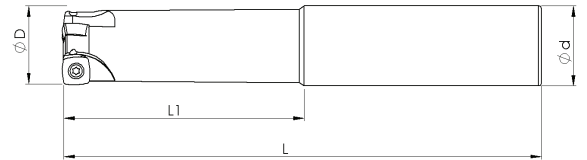

Kesici Uç Uyumluluğu Insert Suitability		Stok Stock	Takım Ölçüleri / Dimension (mm)					Uç Insert	Vida Screw	Anahtar Torx Key
PLBT SP.. 08T3			D	Z	L1	L	d			
SİPARİŞ KODU Ordering Code	SİPARİŞ KODU Ordering Code Inter Coolant									
ST 9285	X	✓	20	2	60	150	20	SPKT 08T3	M3X8	T10
ST 9286	X	✓	25	3	70	150	25	SPKT 08T3	M3X8	T10

## PLBT SDMX 09T3

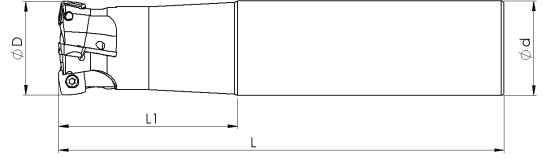

Kesici Uç Uyumluluğu Insert Suitability		Stok Stock	Takım Ölçüleri / Dimension (mm)					Uç Insert	Vida Screw	Anahtar Torx Key
PLBT SDMX 09T3			D	Z	L1	L	d			
SİPARİŞ KODU Ordering Code	SİPARİŞ KODU Ordering Code Inter Coolant									
x	ST 11712	✓	25	3	50	150	25	SDMX 09T3	M3X8	T10
x	ST 11713	✓	32	4	50	150	32	SDMX 09T3	M3X8	T10

## TT BLMP 0603

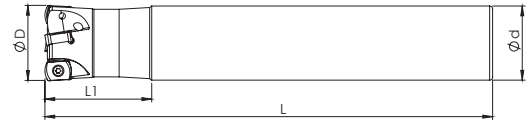

Kesici Uç Uyumluluğu Insert Suitability		Stok Stock	Takım Ölçüleri / Dimension (mm)					Uç Insert	Vida Screw	Anahtar Torx Key
TT BLMP 0603			D	Z	L1	L	d			
SİPARİŞ KODU Ordering Code	SİPARİŞ KODU Ordering Code Inter Coolant									
x	ST 8802	✓	16	2	30	150	15	BLMP 0603	M2,5X8	T08
x	ST 8803	✓	16	2	50	150	16	BLMP 0603	M2,5X8	T08
x	ST 11561	✓	17	2	30	100	16	BLMP 0603	M2,5X8	T08
x	ST 8804	✓	17	2	30	150	16	BLMP 0603	M2,5X8	T08
x	ST 8805	✓	17	2	30	200	16	BLMP 0603	M2,5X8	T08
x	ST 8811	✓	20	3	50	150	20	BLMP 0603	M2,5X8	T08
x	ST 8806	✓	21	3	30	150	20	BLMP 0603	M2,5X8	T08
x	ST 8807	✓	21	3	30	200	20	BLMP 0603	M2,5X8	T08
x	ST 8810	✓	25	4	50	150	25	BLMP 0603	M2,5X8	T08
x	ST 8808	✓	26	4	30	150	25	BLMP 0603	M2,5X8	T08
x	ST 8809	✓	26	4	30	200	25	BLMP 0603	M2,5X8	T08
x	ST 8812	✓	32	5	60	200	32	BLMP 0603	M2,5X8	T08
x	ST 11330	✓	33	5	40	200	32	BLMP 0603	M2,5X8	T08

### KYCR LPGT 0102

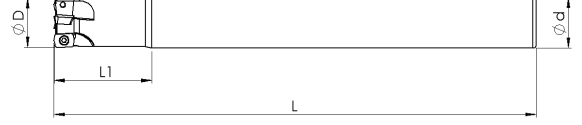

Kesici Uç Uyumluluğu Insert Suitability		Stok Stock	Takım Ölçüleri / Dimension (mm)					Uç Insert	Vida Screw	Anahtar Torx Key
KYCR LPGT 0102			D	Z	L1	L	d			
SİPARİŞ KODU Ordering Code	SİPARİŞ KODU Ordering Code Inter Coolant									
ST 12048	X	✓	10	3	30	120	9	LPGT 0102	M2X5	T06
ST 9075	X	✓	10	2	20	100	10	LPGT 0102	M2X5	T06
ST 9076	X	✓	11	2	22	120	10	LPGT 0102	M2X5	T06
ST 9077	X	✓	12	2	20	120	11	LPGT 0102	M2X5	T06
ST 9078	X	✓	12	3	20	120	11	LPGT 0102	M2X5	T06
ST 9084	X	✓	12	2	25	100	12	LPGT 0102	M2X5	T06
ST 9079	X	✓	12	2	25	120	12	LPGT 0102	M2X5	T06
ST 9085	X	✓	12	3	25	120	12	LPGT 0102	M2X5	T06
ST 9080	X	✓	12	3	80	150	12	LPGT 0102	M2X5	T06
ST 11367	X	✓	14	3	30	120	14	LPGT 0102	M2X5	T06
ST 9083	X	✓	16	4	30	160	16	LPGT 0102	M2X5	T06

### KYCR LOGU 0303

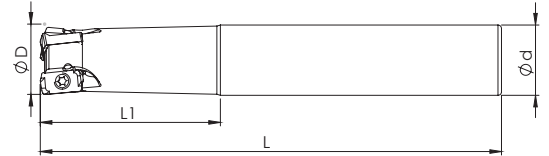

Kesici Uç Uyumluluğu Insert Suitability		Stok Stock	Takım Ölçüleri / Dimension (mm)					Uç Insert	Vida Screw	Anahtar Torx Key
KYCR LOGU 0303			D	Z	L1	L	d			
SİPARİŞ KODU Ordering Code	SİPARİŞ KODU Ordering Code Inter Coolant									
X	ST 9052	✓	16	2	30	160	15	LOGU 0303	M3X8	T08 - T10
X	ST 12428	✓	16	2	35	110	16	LOGU 0303	M3X8	T08 - T10
X	ST 9029	✓	16	2	50	160	16	LOGU 0303	M3X8	T08 - T10
X	ST 9030	✓	16	2	60	200	16	LOGU 0303	M3X8	T08 - T10
X	ST 9031	✓	17	2	30	160	16	LOGU 0303	M3X8	T08 - T10
X	ST 9032	✓	17	2	30	200	16	LOGU 0303	M3X8	T08 - T10
X	ST 9033	✓	18	2	30	160	16	LOGU 0303	M3X8	T08 - T10
X	ST 11376	✓	20	3	35	110	20	LOGU 0303	M3X8	T08 - T10
X	ST 9034	✓	20	3	40	130	20	LOGU 0303	M3X8	T08 - T10
X	ST 9035	✓	20	3	50	160	20	LOGU 0303	M3X8	T08 - T10
X	ST 9053	✓	20	3	60	200	20	LOGU 0303	M3X8	T08 - T10
X	ST 9037	✓	21	3	30	160	20	LOGU 0303	M3X8	T08 - T10
X	ST 12876	✓	21	3	30	200	20	LOGU 0303	M3X8	T08 - T10
X	ST 9039	✓	22	3	30	180	20	LOGU 0303	M3X8	T08 - T10
X	ST 9040	✓	25	4	50	160	25	LOGU 0303	M3X8	T08 - T10
X	ST 9041	✓	25	4	50	180	25	LOGU 0303	M3X8	T08 - T10
X	ST 9043	✓	26	4	30	180	25	LOGU 0303	M3X8	T08 - T10

## KYCR LOGU 0303

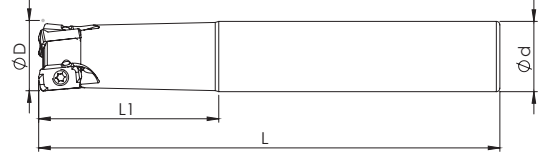

Kesici Uç Uyumluluğu Insert Suitability		Stok Stock	Takım Ölçüleri / Dimension (mm)					Uç İnsert	Vida Screw	Anahtar Torx Key
KYCR LOGU 0303			D	Z	L1	L	d			
SİPARİŞ KODU Ordering Code	SİPARİŞ KODU Ordering Code Inter Coolant									
X	ST 11920	✓	26	4	30	200	25	LOGU 0303	M3X8	T08 - T10
X	ST 11928	✓	26	4	30	250	25	LOGU 0303	M3X8	T08 - T10
X	ST 9051	✓	28	4	30	160	25	LOGU 0303	M3X8	T08 - T10
X	ST 13068	✓	28	4	30	200	25	LOGU 0303	M3X8	T08 - T10
X	ST 9047	✓	32	5	50	160	32	LOGU 0303	M3X8	T08 - T10
X	ST 9048	✓	32	5	60	200	32	LOGU 0303	M3X8	T08 - T10
X	ST 9049	✓	33	5	40	160	32	LOGU 0303	M3X8	T08 - T10

## WLTR P2633 - R10 - R14

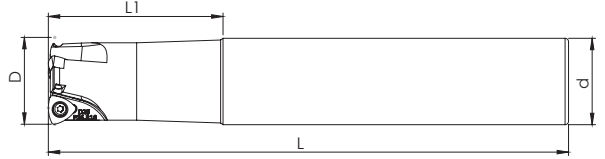

Kesici Uç Uyumluluğu Insert Suitability		Stok Stock	Takım Ölçüleri / Dimension (mm)					Uç İnsert	Vida Screw	Anahtar Torx Key
WLTR P2633 - R10 - R14			D	Z	L1	L	d			
SİPARİŞ KODU Ordering Code	SİPARİŞ KODU Ordering Code Inter Coolant									
X	ST 9128	✓	25	3	50	150	25	P26335R-10	M2,5X7	T08
X	ST 9129	✓	26	3	30	200	25	P26335R-10	M2,5X7	T08
X	ST 9130	✓	32	4	50	150	32	P26335R-10	M2,5X7	T08
X	ST 9131	✓	32	3	50	150	32	P26335R-14	M4X10	T15

## KRLY WNMX 09T3

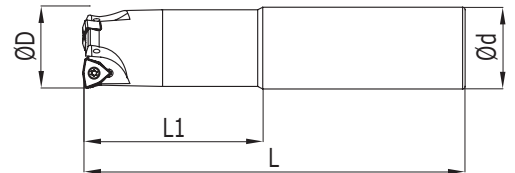

Kesici Uç Uyumluluğu Insert Suitability		Stok Stock	Takım Ölçüleri / Dimension (mm)					Uç İnsert	Vida Screw	Anahtar Torx Key
KRLY WNMX 09T3			D	Z	L1	L	d			
SİPARİŞ KODU Ordering Code	SİPARİŞ KODU Ordering Code Inter Coolant									
X	ST 9336	✓	25	2	70	150	25	WNMX 09T3	M3X8	T10
X	ST 9337	✓	32	3	70	150	32	WNMX 09T3	M3X8	T10

## KRLY WNMX 0603

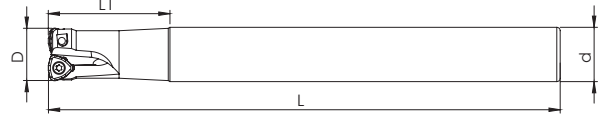

Kesici Uç Uyumluluğu Insert Suitability		Stok Stock	Takım Ölçüleri / Dimension (mm)					Uç İnsert	Vida Screw	Anahtar Torx Key
KRLY WNMX 0603			D	Z	L1	L	d			
SİPARİŞ KODU Ordering Code	SİPARİŞ KODU Ordering Code Inter Coolant									
X	ST 9332	✓	16	2	70	150	16	WNMX 0603	M2,5X7	T08
X	ST 9334	✓	17	2	25	150	16	WNMX 0603	M2,5X7	T08
X	ST 9333	✓	20	3	70	150	20	WNMX 0603	M2,5X7	T08
X	ST 9335	✓	21	3	25	150	20	WNMX 0603	M2,5X7	T08

## KRLY LPMW 0402

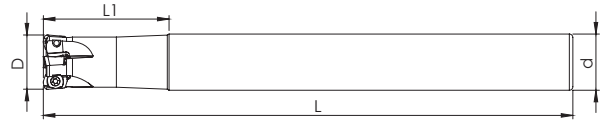

Kesici Uç Uyumluluğu Insert Suitability		Stok Stock	Takım Ölçüleri / Dimension (mm)					Uç İnsert	Vida Screw	Anahtar Torx Key
KRLY LPMW 0402			D	Z	L1	L	d			
SİPARİŞ KODU Ordering Code	SİPARİŞ KODU Ordering Code Inter Coolant									
ST 9103	X	✓	10	2	35	120	10	LPMW 0402	M1,8X4	T06
ST 9104	X	✓	12	3	35	120	12	LPMW 0402	M1,8X4	T06
ST 12440	X	✓	14	4	30	120	12	LPMW 0402	M1,8X4	T06
ST 11201	X	✓	16	4	50	150	16	LPMW 0402	M1,8X4	T06
ST 9105	X	✓	16	4	35	120	16	LPMW 0402	M1,8X4	T06

## KRLY LNMX 0603

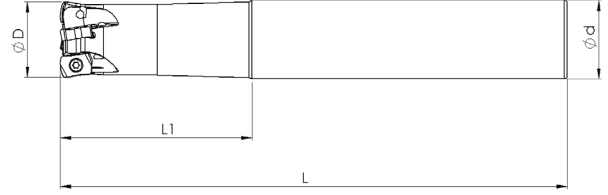

Kesici Uç Uyumluluğu Insert Suitability		Stok Stock	Takım Ölçüleri / Dimension (mm)					Uç Insert	Vida Screw	Anahtar Torx Key
KRLY LNMX 0603			D	Z	L1	L	d			
SİPARİŞ KODU Ordering Code	SİPARİŞ KODU Ordering Code Inter Coolant									
X	ST 11398	✓	16	2	40	130	16	LNMX 0603	M3X8	T10
X	ST 12339	✓	16	2	50	150	16	LNMX 0603	M3X8	T10
X	ST 11715	✓	17	2	30	200	16	LNMX 0603	M3X8	T10
X	ST 11399	✓	20	3	50	150	20	LNMX 0603	M3X8	T10
X	ST 12340	✓	20	3	60	250	20	LNMX 0603	M3X8	T10
X	ST 12341	✓	21	3	30	150	20	LNMX 0603	M3X8	T10
X	ST 12342	✓	25	4	50	150	25	LNMX 0603	M3X8	T10
X	ST 11400	✓	25	4	50	160	25	LNMX 0603	M3X8	T10
X	ST 12343	✓	25	4	60	250	25	LNMX 0603	M3X8	T10
X	ST 12344	✓	32	5	50	150	32	LNMX 0603	M3X8	T10
X	ST 12422	✓	40	6	40	150	32	LNMX 0603	M3X8	T10

## BHLR SDMT 1004

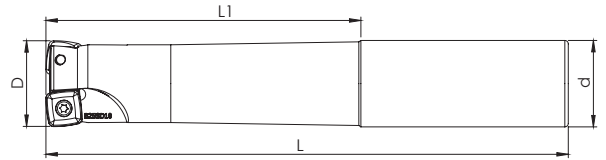

Kesici Uç Uyumluluğu Insert Suitability		Stok Stock	Takım Ölçüleri / Dimension (mm)					Uç Insert	Vida Screw	Anahtar Torx Key
BHLR SDMT 1004			D	Z	L1	L	d			
SİPARİŞ KODU Ordering Code	SİPARİŞ KODU Ordering Code Inter Coolant									
X	ST 9276	✓	32	3	90	150	32	SDMT 1004	M3X8	T10
X	ST 12682	✓	33	3	30	200	32	SDMT 1004	M3X8	T10

### PRMT ZDCW 09T3

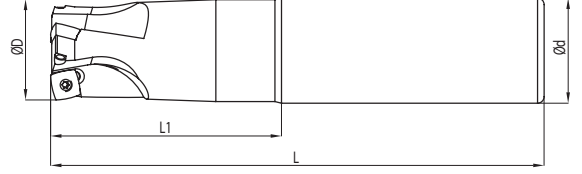

Kesici Uç Uyumluluğu Insert Suitability		Stok Stock	Takım Ölçüleri / Dimension (mm)					Uç Insert	Vida Screw	Anahtar Torx Key
PRMT ZDCW 09T3			D	Z	L1	L	d			
SIPARIŞ KODU Ordering Code	SIPARIŞ KODU Ordering Code Inter Coolant									
X	ST 9429	✓	25	2	50	150	25	ZDCW 09T3	M3X8	T15
X	ST 9430	✓	32	3	50	150	32	ZDCW 09T3	M3X8	T15

### TNGLY LNMU 0303

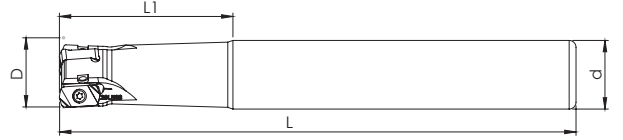

Kesici Uç Uyumluluğu Insert Suitability		Stok Stock	Takım Ölçüleri / Dimension (mm)					Uç Insert	Vida Screw	Anahtar Torx Key
TNGLY LNMU 0303			D	Z	L1	L	d			
SIPARIŞ KODU Ordering Code	SIPARIŞ KODU Ordering Code Inter Coolant									
X	ST 8991	✓	16	2	50	160	16	LNMU 0303	M2,5X7	T08
X	ST 12862	✓	16	2	60	200	16	LNMU 0303	M2,5X7	T08
X	ST 12897	✓	16	2	60	250	16	LNMU 0303	M2,5X7	T08
X	ST 11485	✓	17	2	30	160	16	LNMU 0303	M2,5X7	T08
X	ST 11486	✓	17	2	30	200	16	LNMU 0303	M2,5X7	T08
X	ST 8992	✓	18	2	30	150	16	LNMU 0303	M2,5X7	T08
X	ST 8993	✓	20	3	50	160	20	LNMU 0303	M2,5X7	T08
X	ST 11372	✓	20	3	60	200	20	LNMU 0303	M2,5X7	T08
X	ST 8994	✓	21	3	30	160	20	LNMU 0303	M2,5X7	T08
X	ST 8998	✓	21	3	30	200	20	LNMU 0303	M2,5X7	T08
X	ST 11445	✓	22	3	30	160	20	LNMU 0303	M2,5X7	T08
X	ST 8996	✓	25	4	50	160	25	LNMU 0303	M2,5X7	T08
X	ST 8999	✓	25	4	60	200	25	LNMU 0303	M2,5X7	T08
X	ST 9000	✓	26	4	30	160	25	LNMU 0303	M2,5X7	T08
X	ST 11338	✓	26	4	30	200	25	LNMU 0303	M2,5X7	T08
X	ST 11202	✓	26	4	30	250	25	LNMU 0303	M2,5X7	T08
X	ST 8997	✓	32	4	50	160	32	LNMU 0303	M2,5X7	T08
X	ST 9001	✓	32	4	60	200	32	LNMU 0303	M2,5X7	T08
X	ST 12833	✓	33	5	30	160	32	LNMU 0303	M2,5X7	T08
X	ST 9002	✓	33	4	30	200	32	LNMU 0303	M2,5X7	T08

## WDA XPPT 0703

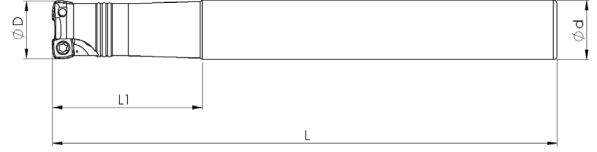

Kesici Uç Uyumluluğu Insert Suitability		Stok Stock	Takım Ölçüleri / Dimension (mm)					Uç Insert	Vida Screw	Anahtar Torx Key
WDA XPPT 0703			D	Z	L1	L	d			
SİPARİŞ KODU Ordering Code	SİPARİŞ KODU Ordering Code Inter Coolant									
X	ST 9418	✓	16	2	50	170	16	XPPT 0703	M3X8	T10
X	ST 9419	✓	20	2	50	170	20	XPPT 0703	M3X8	T10
X	ST 14117	✓	20	3	50	170	20	XPPT 0703	M3X8	T10

## VNDRT XPW. 0603

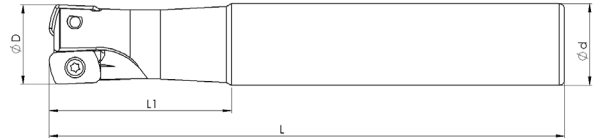

Kesici Uç Uyumluluğu Insert Suitability		Stok Stock	Takım Ölçüleri / Dimension (mm)					Uç Insert	Vida Screw	Anahtar Torx Key
VNDRT XPW. 0603			D	Z	L1	L	d			
SİPARİŞ KODU Ordering Code	SİPARİŞ KODU Ordering Code Inter Coolant									
X	ST 9424	✓	17	2	30	150	16	XPW. 0603	M2,5X6	T08
X	ST 9426	✓	21	3	30	150	20	XPW. 0603	M2,5X6	T08

**PLBT - VNDRT XDHW 0602**

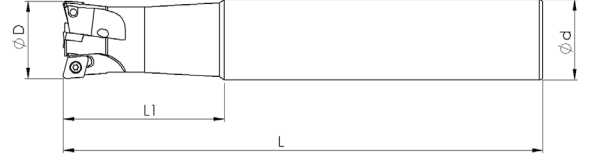

Kesici Uç Uyumluluğu Insert Suitability		Stok Stock	Takım Ölçüleri / Dimension (mm)					Uç Insert	Vida Screw	Anahtar Torx Key
SIPARIŞ KODU Ordering Code	SIPARIŞ KODU Ordering Code Inter Coolant		D	Z	L1	L	d			
X	ST 9349	✓	16	2	50	150	16	XDHW 0602	M2,5X6	T08
X	ST 11854	✓	17	2	30	150	16	XDHW 0602	M2,5X6	T08
X	ST 9350	✓	20	3	50	150	20	XDHW 0602	M2,5X7	T08
X	ST 11716	✓	25	4	50	150	25	XDHW 0602	M2,5X7	T08

**WLTR ENMX 08T3**

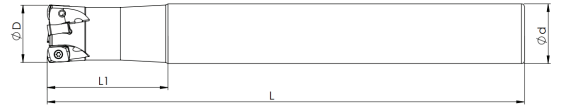

Kesici Uç Uyumluluğu Insert Suitability		Stok Stock	Takım Ölçüleri / Dimension (mm)					Uç Insert	Vida Screw	Anahtar Torx Key
SIPARIŞ KODU Ordering Code	SIPARIŞ KODU Ordering Code Inter Coolant		D	Z	L1	L	d			
X	ST 12268	✓	16	2	40	150	16	ENMX 08T3	M2,5X6	T08
X	ST 12507	✓	16	2	50	200	16	ENMX 08T3	M2,5X6	T08
X	ST 12508	✓	20	3	40	150	20	ENMX 08T3	M2,5X7	T08
X	ST 12548	✓	25	4	40	150	25	ENMX 08T3	M2,5X7	T08

## ISO WDKT 08

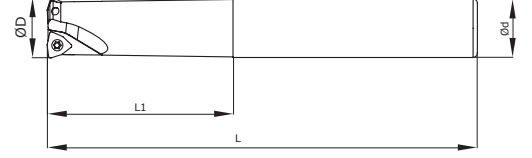

Kesici Uç Uyumluluğu Insert Suitability		Stok Stock	Takım Ölçüleri / Dimension (mm)					Uç Insert	Vida Screw	Anahtar Torx Key
ISO WDKT 08			D	Z	L1	L	d			
SİPARİŞ KODU Ordering Code	SİPARİŞ KODU Ordering Code Inter Coolant									
ST 9321	x	✓	25	2	70	150	25	WDKT 08..	M3X8	T10
ST 9322	x	✓	30	2	70	150	32	WDKT 08..	M3X8	T10
ST 9323	x	✓	32	3	70	150	32	WDKT 08..	M3X8	T10

## ISO RD.. 05 - 07 - 08 - 10 - 12

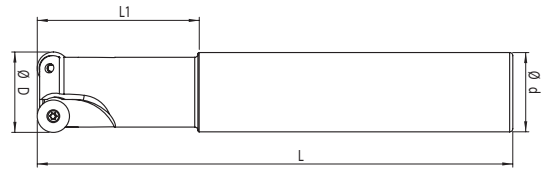

Kesici Uç Uyumluluğu Insert Suitability		Stok Stock	Takım Ölçüleri / Dimension (mm)					Uç Insert	Vida Screw	Anahtar Torx Key
ISO RD.. 05 - 07 - 08 - 10 - 12			D	Z	L1	L	d			
SİPARİŞ KODU Ordering Code	SİPARİŞ KODU Ordering Code Inter Coolant									
ST 9157	x	✓	10	2	40	100	10	RD.. 0501	M2X5	T06
x	ST 9159	✓	12	2	40	100	12	RD.. 0501	M2X5	T06
x	ST 9163	✓	16	2	40	120	16	RD.. 0808	M3X6	T10
x	ST 9164	✓	16	2	40	150	16	RD.. 0808	M3X6	T10
x	ST 9169	✓	20	2	40	120	20	RD.. 1003	M3X8	T10
x	ST 9170	✓	20	2	50	150	20	RD.. 1003	M3X8	T10
x	ST 9171	✓	20	2	50	200	20	RD.. 1003	M3X8	T10
x	ST 9172	✓	25	2	50	150	25	RD.. 1003	M3X8	T10
x	ST 9173	✓	25	2	60	200	25	RD.. 1003	M3X8	T10
x	ST 9174	✓	32	3	60	150	32	RD.. 1003	M3X8	T10
x	ST 9168	✓	32	3	60	200	32	RD.. 1003	M3X8	T10

**ISO RD.. 05 - 07 - 08 - 10 - 12**

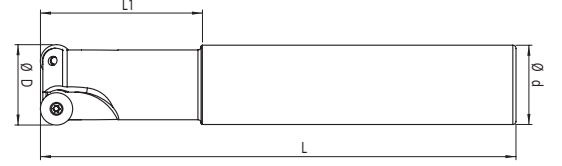

Kesici Uç Uyumluluğu Insert Suitability		Stok Stock	Takım Ölçüleri / Dimension (mm)					Uç Insert	Vida Screw	Anahtar Torx Key
ISO RD.. 05 - 07 - 08 - 10 - 12			D	Z	L1	L	d			
SİPARİŞ KODU Ordering Code	SİPARİŞ KODU Ordering Code Inter Coolant									
ST 9176	x	✓	32	3	100	250	32	RD.. 1003	M3X8	T10
x	ST 9177	✓	40	4	55	150	32	RD.. 1003	M3X8	T10
ST 9178	x	✓	40	2	55	250	32	RD.. 1003	M3X8	T10
ST 9179	x	✓	40	4	55	250	32	RD.. 1003	M3X8	T10
x	ST 9180	✓	20	2	50	150	20	RD.. 10T3	M3,5X8	T15
x	ST 9181	✓	25	2	50	150	25	RD.. 10T3	M3,5X8	T15
x	ST 9182	✓	25	2	70	200	25	RD.. 10T3	M3,5X8	T15
ST 11431	x	✓	32	3	50	160	32	RD.. 10T3	M3,5X8	T15
x	ST 9185	✓	40	4	55	150	32	RD.. 10T3	M3,5X8	T15
x	ST 9186	✓	40	2	55	250	32	RD.. 10T3	M3,5X8	T15
ST 9187	x	✓	40	4	55	250	32	RD.. 10T3	M3,5X8	T15
x	ST 9188	✓	25	2	50	150	25	RD.. 1204	M3,5X10	T15
x	ST 11567	✓	25	2	40	200	25	RD.. 1204	M3,5X10	T15
x	ST 9189	✓	32	3	30	150	25	RD.. 1204	M3,5X10	T15
x	ST 9193	✓	32	3	60	200	25	RD.. 1204	M3,5X10	T15
x	ST 9190	✓	32	3	60	150	32	RD.. 1204	M3,5X10	T15
x	ST 11518	✓	32	3	40	200	32	RD.. 1204	M3,5X10	T15
x	ST 9191	✓	40	4	55	150	25	RD.. 1204	M3,5X10	T15
x	ST 9192	✓	40	4	55	150	32	RD.. 1204	M3,5X10	T15

**ISO RPMW 1003**

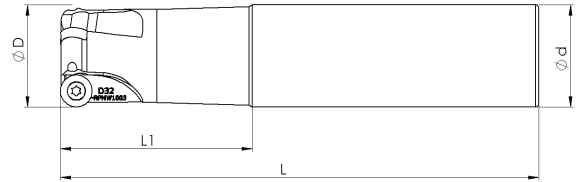

Kesici Uç Uyumluluğu Insert Suitability		Stok Stock	Takım Ölçüleri / Dimension (mm)					Uç Insert	Vida Screw	Anahtar Torx Key
ISO RPMW 1003			D	Z	L1	L	d			
SİPARİŞ KODU Ordering Code	SİPARİŞ KODU Ordering Code Inter Coolant									
x	ST 9224	✓	20	2	50	150	20	RPMW 1003	M3,5X9	T15
x	ST 9225	✓	25	2	50	150	25	RPMW 1003	M3,5X9	T15

## TNGLY RPMT 1204

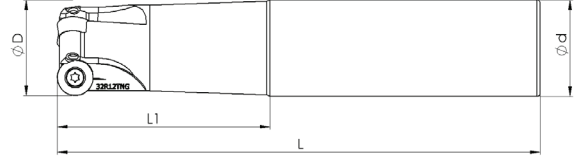

Kesici Uç Uyumluluğu Insert Suitability		Stok Stock	Takım Ölçüleri / Dimension (mm)					Uç İnsert	Vida Screw	Anahtar Torx Key
TNGLY RPMT 1204			D	Z	L1	L	d			
SİPARİŞ KODU Ordering Code	SİPARİŞ KODU Ordering Code Inter Coolant									
X	ST 9221	✓	25	2	50	160	25	RPMT 1204	M4X10	T15
X	ST 9222	✓	30	3	40	160	25	RPMT 1204	M4X10	T15
X	ST 9223	✓	32	3	50	160	32	RPMT 1204	M4X10	T15

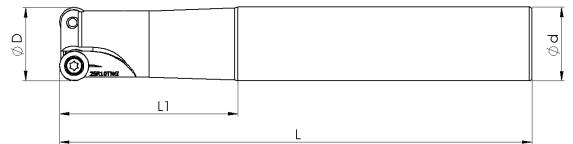

## TNGLY RPMT 10T3



Kesici Uç Uyumluluğu Insert Suitability		Stok Stock	Takım Ölçüleri / Dimension (mm)					Uç İnsert	Vida Screw	Anahtar Torx Key
TNGLY RPMT 10T3			D	Z	L1	L	d			
SİPARİŞ KODU Ordering Code	SİPARİŞ KODU Ordering Code Inter Coolant									
X	ST 9216	✓	20	2	50	150	20	RPMT 10T3	M3,5X8	T15
X	ST 9218	✓	25	2	50	160	25	RPMT 10T3	M3,5X8	T15
X	ST 9220	✓	32	3	50	160	32	RPMT 10T3	M3,5X8	T15

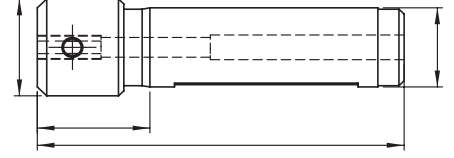

### HRN B.ST

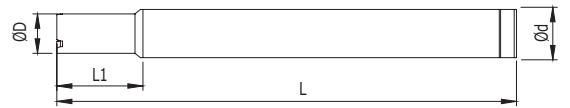

Kesici Uç Uyumluluğu Insert Suitability		Stok Stock	Takım Ölçüleri / Dimension (mm)				Uç Insert	Vida Screw	Anahtar Torx Key
HRN B.ST			D	L1	L	d			
SİPARİŞ KODU Ordering Code	SİPARİŞ KODU Ordering Code Inter Coolant								
X	PC 6826	✓	20	20	70	16	A05.0016.07.B.ST	M4X8	T15
X	PC 11405	✓	25	20	70	20	A07.0020.07.B.ST	M4X8	T15
X	PC 6827	✓	25	20	70	20	A08.0020.09.B.ST	M4X8	T15
X	PC 6828	✓	30	20	90	25	A09.0025.07.B.ST	M4X8	T15

### HRN - HD 12



Kesici Uç Uyumluluğu Insert Suitability		Stok Stock	Takım Ölçüleri / Dimension (mm)				Uç Insert	Vida Screw	Anahtar Torx Key
HRN - HD 12			D	L1	L	d			
SİPARİŞ KODU Ordering Code	SİPARİŞ KODU Ordering Code Inter Coolant								
PC 7224	X	✓	6	18	100	12	HD 12-6 R	M3X10	T10
PC 7225	X	✓	7	18	100	12	HD 12-7 R	M3X10	T10
PC 7226	X	✓	8	18	100	12	HD 12-8 R	M3,5X11	T15
PC 7227	X	✓	9	18	100	12	HD 12-9 R	M3,5X11	T15
PC 7229	X	✓	11	18	100	12	HD 12-11 R	M4,5X12	T20

## DİŞ TARAĞI

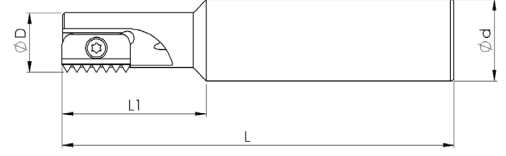

Kesici Uç Uyumluluğu Insert Suitability		Stok Stock	Takım Ölçüleri / Dimension (mm)					Uç Insert	Vida Screw	Anahtar Torx Key
DİŞ TARAĞI			D	Z	L1	L	d			
SİPARİŞ KODU - R Ordering Code - R	SİPARİŞ KODU - L Ordering Code - L									
CPT 7207	X	✓	16	1	25	120	16	CPT C14	M4X9	T15
CPT 7208	X	✓	18	1	33	100	20	CPT C21	M4X9	T15
CPT 7209	X	✓	21	1	44	120	25	CPT C21	M4X11	T15
CPT 7210	X	✓	25	1	44	120	25	CPT C21	M4X11	T15

## VİDALI TAKIM TUTUCU

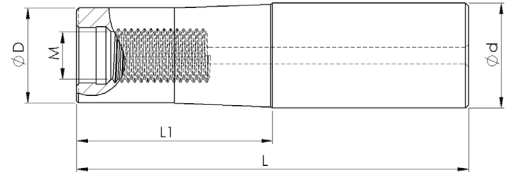





Kesici Uç Uyumluluğu Insert Suitability		Stok Stock	Takım Ölçüleri / Dimension (mm)					
VİDALI TAKIM TUTUCU			M	D	d	L1	L	VİDA
SİPARİŞ KODU Ordering Code	SİPARİŞ KODU Ordering Code Inter Coolant							
X	VTU 10922	✓	M12	22	25	60	120	M12
X	VTU 10923	✓	M12	22	25	100	160	M12
X	VTU 10924	✓	M12	22	25	140	200	M12
X	VTU 10925	✓	M16	30	32	60	120	M16
X	VTU 10926	✓	M16	30	32	100	160	M16
X	VTU 10927	✓	M16	30	32	140	200	M16
X	VTU 13076	✓	M16	30	32	140	250	M16

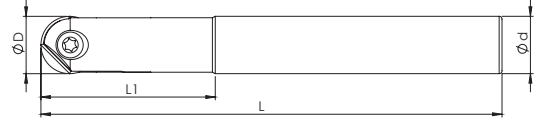

**HIGH FEED FINISH TAKIMLARI**  
HIGH FEED FINISH TOOLS



WLTR P3201 - P3204



Kesici Uç Uyumluluğu Insert Suitability			Takım Ölçüleri / Dimension (mm)				Uç İnsert	Vida Screw	Anahtar Torx Key
WLTR P3201 - P3204		Stok Stock	D	d	L1	L			
SİPARİŞ KODU - R Ordering Code - R	SİPARİŞ KODU - L Ordering Code - L								
ST 8754	X	✓	10	12	30	130	P3201-D10	M4X9 D10	T20
ST 8755	X	✓	12	12	32	130	P3204-D12	M5X10 D12	T20
ST 8756	X	✓	16	16	36	140	P3204-D16	M5X12 D16	T20
ST 8757	X	✓	20	20	45	180	P3204-D20	M5X16 D20	T20
ST 8758	X	✓	25	25	45	160	P3201-D25	M6X22 D25	T20

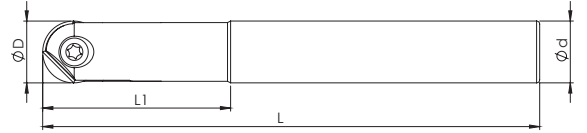

ZCC ROHX 12 - 16 - 20

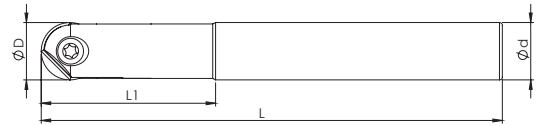

Kesici Uç Uyumluluğu Insert Suitability			Takım Ölçüleri / Dimension (mm)				Uç İnsert	Vida Screw	Anahtar Torx Key
ZCC ROHX 12 - 16 - 20		Stok Stock	D	d	L1	L			
SİPARİŞ KODU - R Ordering Code - R	SİPARİŞ KODU - L Ordering Code - L								
ST 9205	X	✓	16	16	45	160	ROHX 1604	M5X0,5X12 D16	T20
ST 9206	X	✓	16	16	60	190	ROHX 1604	M5X0,5X12 D16	T20
ST 9207	X	✓	16	16	60	250	ROHX 1604	M5X0,5X12 D16	T20
ST 9208	X	✓	20	20	45	160	ROHX 2005	M5X0,5X16 D20	T20
ST 9209	X	✓	20	20	60	200	ROHX 2005	M5X0,5X16 D20	T20
ST 9211	X	✓	20	25	60	240	ROHX 2005	M5X0,5X16 D20	T20

ZCC ZOHX 12 - 16 - 20 - 25 - 32



Kesici Uç Uyumluluğu Insert Suitability			Takım Ölçüleri / Dimension (mm)				Uç İnsert	Vida Screw	Anahtar Torx Key
ZCC ZOHX 12 - 16 - 20 - 25 - 32		Stok Stock	D	d	L1	L			
SİPARİŞ KODU - R Ordering Code - R	SİPARİŞ KODU - L Ordering Code - L								
ST 9432	X	✓	16	16	60	180	ZOHX 1604	M5X0,5X12 D16	T20
ST 9433	X	✓	20	20	60	200	ZOHX 2005	M5X0,5X16 D20	T20
ST 9434	X	✓	25	25	60	250	ZOHX 2506	M6X0,75X22 D25	T20
ST 9438	X	✓	32	32	60	250	ZOHX 3207	M8X1X25 D32	T20



## FREZELEME TAKIMLARI FACE MILLING

## ISO CCMT 06 - 09 -12 DISK FREZE

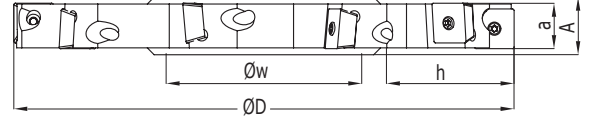
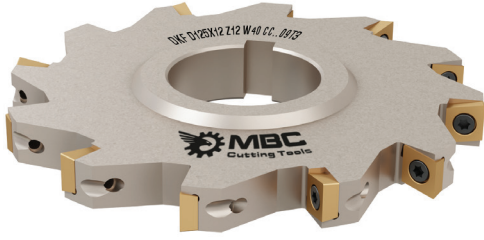

Kesici Uç Uyumluluğu Insert Suitability		Stok Stock	Takım Ölçüleri / Dimension (mm)						Uç Insert	Vida Screw	Anahtar Torx Key
ISO CCMT 06 - 09 -12 DISK FREZE			D	a	A	Z	h	w			
SİPARİŞ KODU - R Ordering Code - R	SİPARİŞ KODU - L Ordering Code - L										
DKF 6900	X	✓	80	8	12	10	16	27	CC.T 0602	M2,5X6	T08
DKF 6901	X	✓	100	8	12	12	24	32	CC.T 0602	M2,5X6	T08
DKF 6902	X	✓	125	8	12	14	34	40	CC.T 0602	M2,5X6	T08
DKF 6903	X	✓	160	8	12	16	50	40	CC.T 0602	M2,5X6	T08
DKF 6904	X	✓	80	10	14	10	16	27	CC.T 0602	M2,5X6	T08
DKF 6905	X	✓	100	10	14	12	24	32	CC.T 0602	M2,5X6	T08
DKF 6906	X	✓	125	10	14	14	34	40	CC.T 0602	M2,5X6	T08
DKF 6907	X	✓	160	10	14	16	50	40	CC.T 0602	M2,5X6	T08
DKF 6908	X	✓	80	12	16	8	16	27	CC.T 09T3	M3,5X9	T15
DKF 6909	X	✓	100	12	16	10	24	32	CC.T 09T3	M3,5X9	T15
DKF 6910	X	✓	125	12	16	12	34	40	CC.T 09T3	M3,5X9	T15
DKF 6911	X	✓	160	12	16	14	50	40	CC.T 09T3	M3,5X9	T15
DKF 6912	X	✓	80	14	18	8	16	27	CC.T 09T3	M3,5X9	T15
DKF 6913	X	✓	100	14	18	10	24	32	CC.T 09T3	M3,5X9	T15
DKF 6914	X	✓	125	14	18	12	34	40	CC.T 09T3	M3,5X9	T15
DKF 6915	X	✓	160	14	18	14	50	40	CC.T 09T3	M3,5X9	T15
DKF 6916	X	✓	80	16	20	8	16	27	CC.T 1204	M5X12	T20
DKF 6917	X	✓	100	16	20	8	24	32	CC.T 1204	M5X12	T20
DKF 6918	X	✓	125	16	20	10	34	40	CC.T 1204	M5X12	T20
DKF 6919	X	✓	160	16	20	12	50	40	CC.T 1204	M5X12	T20

## ISO APKT 1003 HELİSEL FREZE

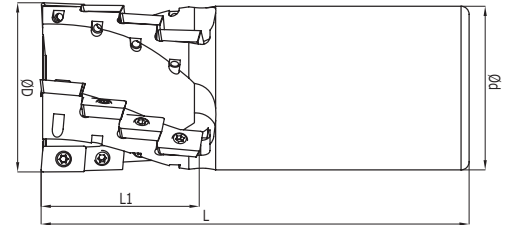

Kesici Uç Uyumluluğu Insert Suitability		Stok Stock	Takım Ölçüleri / Dimension (mm)					Uç Insert	Vida Screw	Anahtar Torx Key
ISO APKT 1003 HELİSEL FREZE			D	Z	L1	L	d			
SİPARİŞ KODU Ordering Code	SİPARİŞ KODU Ordering Code Inter Coolant									
X	STHF 7776	✓	20	6	110	27	20	APKT 1003	M2,5X7	T08
X	STHF 7777	✓	25	8	120	36	25	APKT 1003	M2,5X7	T08
X	STHF 7778	✓	32	15	120	45	32	APKT 1003	M2,5X7	T08
X	STHF 7779	✓	40	18	130	54	32	APKT 1003	M2,5X7	T08

### ZCC LNKT 1205

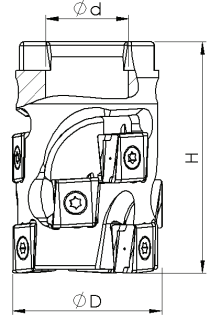

Kesici Uç Uyumluluğu Insert Suitability		Stok Stock	Takım Ölçüleri / Dimension (mm)				Uç Insert	Vida Screw	Anahtar Torx Key
ZCC LNKT 1205			D	Z	H	d			
SİPARİŞ KODU Ordering Code	SİPARİŞ KODU Ordering Code Inter Coolant								
X	TKHF 12438	✓	50	16	67	27	LNKT 1206	M4X11	T15
X	TKHF 12920	✓	50	16	67	22	LNKT 1206	M4X11	T15

### ISO APKT 1604 HELİSEL FREZE

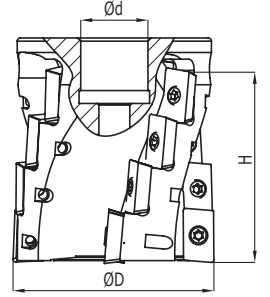

Kesici Uç Uyumluluğu Insert Suitability		Stok Stock	Takım Ölçüleri / Dimension (mm)				Uç Insert	Vida Screw	Anahtar Torx Key
ISO APKT 1604 HELİSEL FREZE			D	Z	H	d			
SİPARİŞ KODU Ordering Code	SİPARİŞ KODU Ordering Code Inter Coolant								
TKHF 9961	X	✓	50	12	42	22	APKT 1604	M3,5X8	T15
TKHF 9962	X	✓	63	16	56	22	APKT 1604	M3,5X8	T15
TKHF 9963	X	✓	80	25	70	27	APKT 1604	M3,5X8	T15

### ISO TCMT 11 - 16 HAVŞA MATKABI

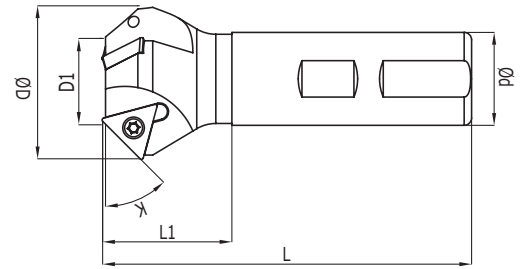

Kesici Uç Uyumluluğu Insert Suitability		Stok Stock	Takım Ölçüleri / Dimension (mm)								Uç Insert	Vida Screw	Anahtar Torx Key
ISO TCMT 11 - 16 HAVŞA MATKABI			K	D	Z	D1	d	L	L1				
SİPARİŞ KODU - R Ordering Code - R	SİPARİŞ KODU - L Ordering Code - L												
HM 7230	X	✓	45°	15	1	4	16	L100	35	TC.T 11..	M2,5X7	T08	
HM 7231	X	✓	45°	25	2	14	16	L120	35	TC.T 11..	M2,5X7	T08	
HM 7232	X	✓	45°	30	3	16	16	L100	35	TC.T 11..	M2,5X7	T08	
HM 7233	X	✓	45°	35	3	21	16	L100	35	TC.T 11..	M2,5X7	T08	
HM 7234	X	✓	45°	23	1	5	16	L100	35	TC.T 16T3	M3,5X8	T15	
HM 7235	X	✓	45°	31	2	10	16	L100	35	TC.T 16T3	M3,5X8	T15	
HM 7236	X	✓	45°	35	2	14	20	L100	35	TC.T 16T3	M3,5X8	T15	
HM 7238	X	✓	45°	43	3	22	25	L100	35	TC.T 16T3	M3,5X8	T15	
HM 7239	X	✓	45°	50	3	30	25	L100	35	TC.T 16T3	M3,5X8	T15	
HM 7241	X	✓	60°	20	3	6	16	L100	35	TC.T 16T3	M3,5X8	T15	
HM 7242	X	✓	60°	35	2	20	20	L100	35	TC.T 16T3	M3,5X8	T15	
HM 7243	X	✓	60°	40	2	24	25	L100	35	TC.T 16T3	M3,5X8	T15	

## ISO CCMT 06 - 09 T FREZE

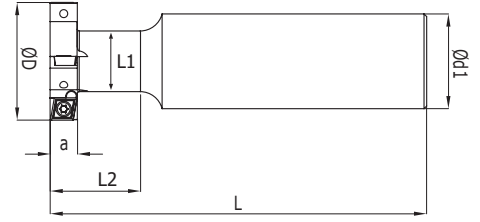

Kesici Uç Uyumluluğu Insert Suitability		Stok Stock	Takım Ölçüleri / Dimension (mm)							Uç Insert	Vida Screw	Anahtar Torx Key
ISO CCMT 06 - 09 T FREZE	SIPARIŞ KODU - R Ordering Code - R		SIPARIŞ KODU - L Ordering Code - L	D	Z	a	L	L1	L2	d1		
TF 9680	X	✓	14	2	7	85	8	15	16	SP.. 050204	M2X6	T06
TF 13112	X	✓	17	2	9	85	9	20	16	CC.T 0602	M2,5X7	T08
TF 9664	X	✓	20	2	9	85	10	20	16	CC.T 0602	M2,5X7	T08
TF 9665	X	✓	21	2	9	85	10	20	16	CC.T 0602	M2,5X7	T08
TF 9666	X	✓	24	2	10	100	12	25	20	CC.T 0602	M2,5X7	T08
TF 9667	X	✓	25	2	11	100	12	25	25	CC.T 0602	M2,5X7	T08
TF 9668	X	✓	25	2	12	100	12	25	25	CC.T 0602	M2,5X7	T08
TF 9669	X	✓	32	4	8	100	16	25	25	CC.T 0602	M2,5X7	T08
TF 9684	X	✓	32	4	8,5	120	18	30	20	CC.T 0602	M2,5X7	T08
TF 9670	X	✓	32	4	10	100	16	30	25	CC.T 0602	M2,5X7	T08
TF 9685	X	✓	42	4	8	120	18	30	25	CC.T 0602	M2,5X7	T08
TF 9671	X	✓	63	8	8	125	31	40	32	CC.T 0602	M2,5X7	T08
TF 9672	X	✓	30	2	12	100	16	30	25	CC.T 09T3	M3,5X8	T15
TF 9673	X	✓	32	2	14	100	16	30	25	CC.T 09T3	M3,5X8	T15
TF 9674	X	✓	40	4	16	120	18	30	32	CC.T 09T3	M3,5X8	T15
TF 9675	X	✓	40	4	18	120	18	30	32	CC.T 09T3	M3,5X8	T15
TF 9676	X	✓	32	2	12	100	16	30	25	CC.T 09T3	M3,5X8	T15
TF 9677	X	✓	40	4	12	120	18	30	32	CC.T 09T3	M3,5X8	T15
TF 9678	X	✓	50	4	12	120	18	30	32	CC.T 09T3	M3,5X8	T15
TF 9679	X	✓	50	4	16	120	18	30	32	CC.T 09T3	M3,5X8	T15

## DCMT 11 55° ISO KIRLANGIÇ FREZE

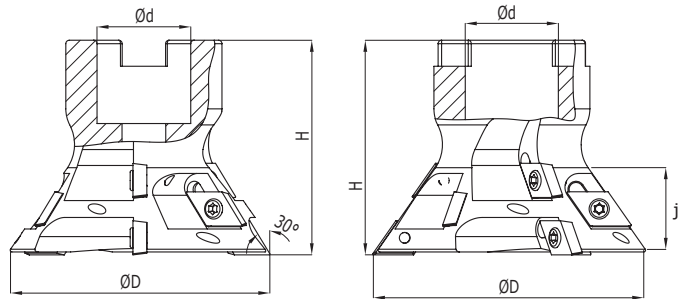
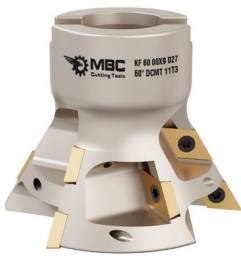

Kesici Uç Uyumluluğu Insert Suitability		Stok Stock	Takım Ölçüleri / Dimension (mm)						Uç Insert	Vida Screw	Anahtar Torx Key
DCMT 11 55° ISO KIRLANGIÇ FREZE	SIPARIŞ KODU - R Ordering Code - R		SIPARIŞ KODU - L Ordering Code - L	D	Z	H	d	j	K		
TKF 10008	X	✓	50	4	45	22	9	60°	DC.T 11T3	M3,5X11	T15
TKF 10009	X	✓	80	9	61	27	26	60°	DC.T 11T3	M3,5X11	T15
TKF 10007	X	✓	80	9	61	27	24	55°	DC.T 11T3	M3,5X11	T15

### SKRF 55° - 60° ISO DCMT 11T3

NEW

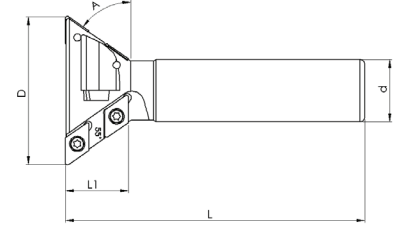

Kesici Uç Uyumluluğu Insert Suitability			Takım Ölçüleri / Dimension (mm)						Uç Insert	Vida Screw	Anahtar Torx Key	
ISO DCMT 11T3			Stok Stock	A	D	Z	L	d	L1			
SİPARİŞ KODU Ordering Code	SİPARİŞ KODU Ordering Code Inter Coolant											
SKF 17027	x	✓	60	50	4	120	25	18	DCMT 11T3	M3,5X11	T15	
SKF 17028	x	✓	55	60	6	120	25	25	DCMT 11T3	M3,5X11	T15	

### TF45 TGTC SPMG 09

NEW

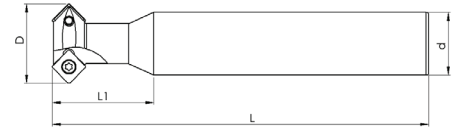

Kesici Uç Uyumluluğu Insert Suitability			Takım Ölçüleri / Dimension (mm)						Uç Insert	Vida Screw	Anahtar Torx Key
TGTC SPMG 09			Stok Stock	D	Z	L	d	L1			
SİPARİŞ KODU Ordering Code	SİPARİŞ KODU Ordering Code Inter Coolant										
TF 17029	x	✓	32	2	150	25	40	SP..090408	M3,5X8	T15	
TF 17030	x	✓	40	3	150	25	50	SP..090408	M3,5X8	T15	
TF 21239	x	✓	13-27	1	150	20	30	SP..1104	M4X11	T15	
TF 21240	x	✓	25-39	2	150	25	40	SP..1104	M4X11	T15	
TF 14364	x	✓	32-46	3	150	25	50	SP..1104	M4X11	T15	

### T SLOT MILLS MGM. DKT

NEW

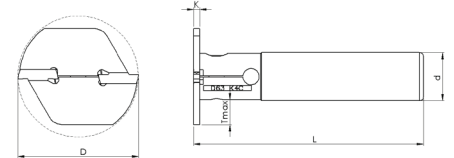
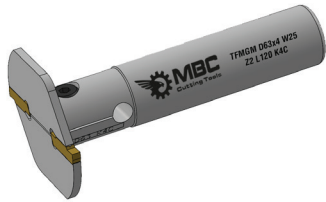

Kesici Uç Uyumluluğu Insert Suitability			Takım Ölçüleri / Dimension (mm)							Uç Insert	Vida Screw	Anahtar Allen Key
MGM. DKT			Stok Stock	D	K	Z	L	d	Tmax			
SİPARİŞ KODU - R Ordering Code - R	SİPARİŞ KODU - L Ordering Code - L											
STF 17031	x	✓	50	3	2	120	25	12,75	MGM.3	M8X27	A4	
STF 17032	x	✓	63	3	2	120	25	19,25	MGM.3	M8X27	A4	
STF 17033	x	✓	80	3	2	120	32	24,25	MGM.3	M8X27	A4	
STF 17034	x	✓	50	4	2	120	25	12,75	MGM.4	M8X27	A4	
STF 17035	x	✓	63	4	2	120	25	19,25	MGM.4	M8X27	A4	
STF 17036	x	✓	80	4	2	120	32	24,25	MGM.4	M8X27	A4	
STF 17037	x	✓	55	5	2	120	25	15,25	MGM.5	M8X27	A4	
STF 17038	x	✓	63	5	2	120	25	19,25	MGM.5	M8X27	A4	
STF 17039	x	✓	80	5	2	120	32	24,25	MGM.5	M8X27	A4	



# TARAMA KAFALARI FACE MILLING

**90° ISO TPKN 1603**

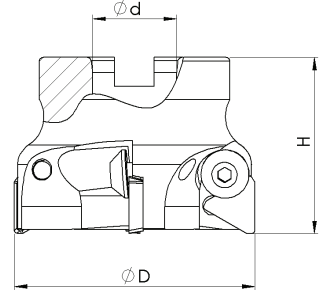
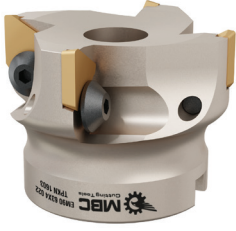

Kesici Uç Uyumluluğu Insert Suitability			Takım Ölçüleri / Dimension (mm)				Uç Insert	Vida Screw	Anahtar Allen Key
90° ISO TPKN 1603		Stok Stock	D	Z	H	d			
SİPARİŞ KODU Ordering Code	SİPARİŞ KODU Ordering Code Inter Coolant								
TK 10400	X	✓	50	3	41	22	TPKN 1603	M6X0,75	A4
TK 10401	X	✓	63	4	48	22	TPKN 1603	M6X0,75	A4
TK 10402	X	✓	80	5	52	32	TPKN 1603	M6X0,75	A4
TK 10403	X	✓	100	6	52	32	TPKN 1603	M6X0,75	A4

**90° ISO TPKN 2204**

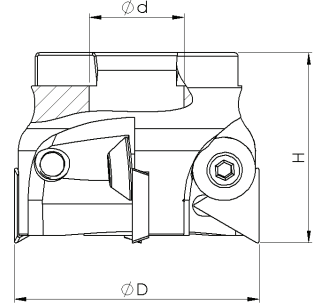
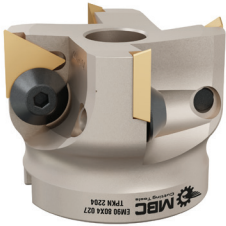

Kesici Uç Uyumluluğu Insert Suitability			Takım Ölçüleri / Dimension (mm)				Uç Insert	Vida Screw	Anahtar Allen Key
90° ISO TPKN 2204		Stok Stock	D	Z	H	d			
SİPARİŞ KODU Ordering Code	SİPARİŞ KODU Ordering Code Inter Coolant								
TK 10404	X	✓	63	3	48	22	TPKN 2204	M8X1	A5
TK 10405	X	✓	80	4	52	27	TPKN 2204	M8X1	A5
TK 10406	X	✓	80	4	52	32	TPKN 2204	M8X1	A5
TK 10407	X	✓	100	5	52	32	TPKN 2204	M8X1	A5
TK 10408	X	✓	125	6	62	32	TPKN 2204	M8X1	A5
TK 10409	X	✓	125	6	62	40	TPKN 2204	M8X1	A5
TK 10410	X	✓	160	7	62	40	TPKN 2204	M8X1	A5
TK 10411	X	✓	200	8	62	60	TPKN 2204	M8X1	A5
TK 10412	X	✓	250	10	62	60	TPKN 2204	M8X1	A5

## 90° ISO APKT 1003

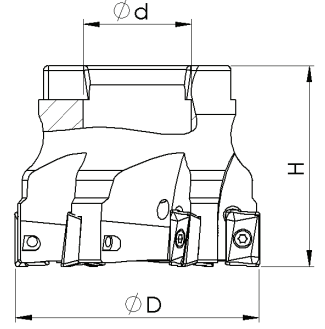

Kesici Uç Uyumluluğu Insert Suitability		Stok Stock	Takım Ölçüleri / Dimension (mm)				Uç İnsert	Vida Screw	Anahtar Torx Key
90° ISO APKT 1003			D	Z	H	d			
SİPARİŞ KODU Ordering Code	SİPARİŞ KODU Ordering Code Inter Cooland								
TK 9844	TK 9845	✓	40	5	45	16	APKT 1003	M2,5X7	T08
TK 9846	TK 9847	✓	50	6	45	22	APKT 1003	M2,5X7	T08
TK 9848	TK 9849	✓	63	7	45	22	APKT 1003	M2,5X7	T08
TK 9850	TK 9851	✓	80	8	52	27	APKT 1003	M2,5X7	T08
TK 9852	TK 9853	✓	100	9	52	32	APKT 1003	M2,5X7	T08

## 90° ISO APKT 1604

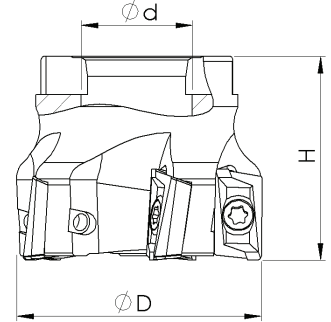
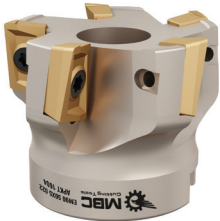

Kesici Uç Uyumluluğu Insert Suitability		Stok Stock	Takım Ölçüleri / Dimension (mm)				Uç İnsert	Vida Screw	Anahtar Torx Key
90° ISO APKT 1604			D	Z	H	d			
SİPARİŞ KODU Ordering Code	SİPARİŞ KODU Ordering Code Inter Cooland								
TK 9863	TK 9864	✓	40	4	45	16	APKT 1604	M3,5X10	T15
TK 9865	TK 9866	✓	50	4	45	22	APKT 1604	M3,5X10	T15
TK 9867	TK 9868	✓	50	5	45	22	APKT 1604	M3,5X10	T15
TK 9869	TK 9870	✓	63	5	45	22	APKT 1604	M3,5X10	T15
TK 9871	TK 9872	✓	80	6	52	27	APKT 1604	M3,5X10	T15
TK 9873	TK 9874	✓	80	6	52	32	APKT 1604	M3,5X10	T15
TK 9875	X	✓	80	7	52	27	APKT 1604	M3,5X10	T15
TK 9876	TK 9877	✓	100	8	52	32	APKT 1604	M3,5X10	T15
TK 9880	X	✓	125	9	62	40	APKT 1604	M3,5X10	T15
TK 9881	X	✓	160	10	62	40	APKT 1604	M3,5X10	T15
TK 9882	X	✓	200	12	62	60	APKT 1604	M3,5X10	T15
TK 9883	X	✓	250	14	62	60	APKT 1604	M3,5X10	T15

**90° ISO VCGT 2205**

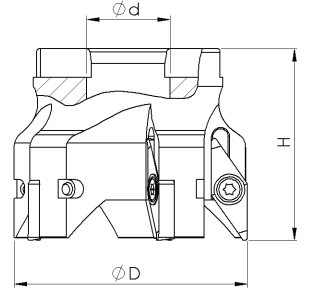
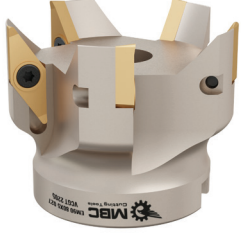

Kesici Uç Uyumluluğu Insert Suitability		Stok Stock	Takım Ölçüleri / Dimension (mm)				Uç İnsert	Vida Screw	Anahtar Torx Key
90° ISO VCGT 2205			D	Z	H	d			
SİPARİŞ KODU Ordering Code	SİPARİŞ KODU Ordering Code Inter Coolant								
X	TK 10421	✓	50	3	50	22	VCGT 2205	M5X12	T20
X	TK 12444	✓	63	3	60	22	VCGT 2205	M5X12	T20
X	TK 10423	✓	80	5	52	27	VCGT 2205	M5X12	T20

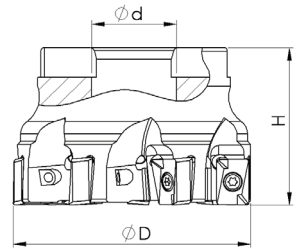

**90° ANKX 09 I**



Kesici Uç Uyumluluğu Insert Suitability		Stok Stock	Takım Ölçüleri / Dimension (mm)				Uç İnsert	Vida Screw	Anahtar Torx Key
90° ANKX 09 I			D	Z	H	d			
SİPARİŞ KODU Ordering Code	SİPARİŞ KODU Ordering Code Inter Coolant								
X	TK 12618	✓	63	7	40	22	ANKX 09	M3X8	T10

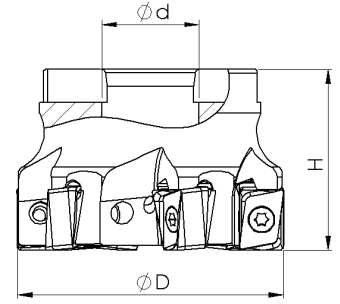
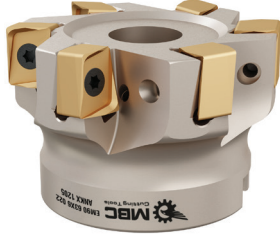

## 90° ANKX 1205 I

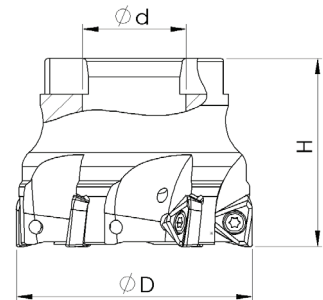

Kesici Uç Uyumluluğu Insert Suitability		Stok Stock	Takım Ölçüleri / Dimension (mm)				Uç Insert	Vida Screw	Anahtar Torx Key
90° ANKX 1205 I			D	Z	H	d			
SİPARİŞ KODU Ordering Code	SİPARİŞ KODU Ordering Code Inter Coolant								
X	TK 9817	✓	50	5	40	22	ANKX 1205	M4X14	T15
X	TK 9818	✓	63	6	45	22	ANKX 1205	M4X14	T15
X	TK 9819	✓	80	7	52	27	ANKX 1205	M4X14	T15
X	TK 9820	✓	100	8	52	32	ANKX 1205	M4X14	T15
TK 11375	X	✓	125	10	62	40	ANKX 1205	M4X14	T15

## 90° TPKT 1003 I



Kesici Uç Uyumluluğu Insert Suitability		Stok Stock	Takım Ölçüleri / Dimension (mm)				Uç Insert	Vida Screw	Anahtar Torx Key
90° TPKT 1003 I			D	Z	H	d			
SİPARİŞ KODU Ordering Code	SİPARİŞ KODU Ordering Code Inter Coolant								
X	TK 10413	✓	40	5	40	16	TPKT 1003	M3X8	T10
X	TK 10414	✓	50	6	40	22	TPKT 1003	M3X8	T10
X	TK 10415	✓	63	7	40	22	TPKT 1003	M3X8	T10

**90° TDKT 1505 I**

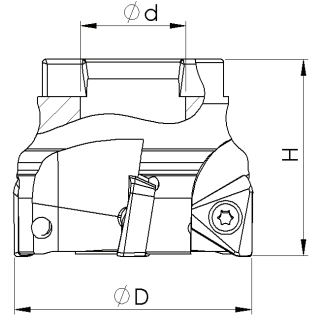

Kesici Uç Uyumluluğu Insert Suitability		Stok Stock	Takım Ölçüleri / Dimension (mm)				Uç Insert	Vida Screw	Anahtar Torx Key
90° TDKT 1505 I			D	Z	H	d			
SİPARİŞ KODU Ordering Code	SİPARİŞ KODU Ordering Code Inter Coolant								
TK 10396	X	✓	50	4	40	22	TDKT 1505	M5X12	T20
TK 10397	X	✓	63	5	40	22	TDKT 1505	M5X12	T20
TK 14203	X	✓	80	6	52	27	TDKT 1505	M5X12	T20
TK 14204	X	✓	100	7	52	32	TDKT 1505	M5X12	T20

**90° AD.. 1505 I**

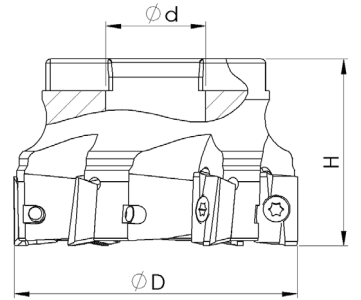

Kesici Uç Uyumluluğu Insert Suitability		Stok Stock	Takım Ölçüleri / Dimension (mm)				Uç Insert	Vida Screw	Anahtar Torx Key
90° AD.. 1505 I			D	Z	H	d			
SİPARİŞ KODU Ordering Code	SİPARİŞ KODU Ordering Code Inter Coolant								
TK 11586	X	✓	40	4	40	16	ADKT 1505	M4X11	T15
TK 11587	X	✓	50	5	40	22	ADKT 1505	M4X11	T15
TK 11588	X	✓	63	6	40	22	ADKT 1505	M4X11	T15
TK 12742	X	✓	80	7	52	27	ADKT 1505	M4X11	T15
TK 13114	X	✓	100	8	52	32	ADKT 1505	M4X11	T15

90° LN.. 0804 I

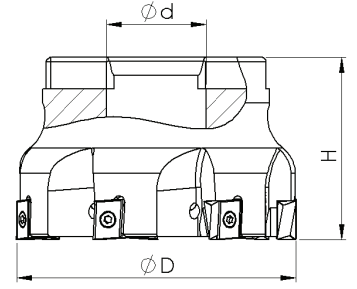

Kesici Uç Uyumluluğu Insert Suitability		Stok Stock	Takım Ölçüleri / Dimension (mm)				Uç Insert	Vida Screw	Anahtar Torx Key
SİPARİŞ KODU Ordering Code	SİPARİŞ KODU Ordering Code Inter Cooland		D	Z	H	d			
X	TK 11732	✓	50	5	40	22	LNMT 0804	M2,5X8	T08
X	TK 10044	✓	63	7	40	22	LNMT 0804	M2,5X8	T08

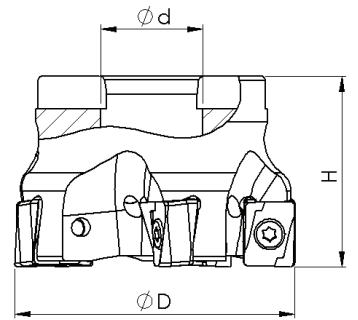

90° LNGX 1307 WLTR



Kesici Uç Uyumluluğu Insert Suitability		Stok Stock	Takım Ölçüleri / Dimension (mm)				Uç Insert	Vida Screw	Anahtar Torx Key
SİPARİŞ KODU Ordering Code	SİPARİŞ KODU Ordering Code Inter Cooland		D	Z	H	d			
X	TK 10033	✓	50	4	40	22	LNGX 1307	M4X14	T15
X	TK 10034	✓	63	5	45	22	LNGX 1307	M4X14	T15
X	TK 10032	✓	80	7	52	27	LNGX 1307	M4X14	T15
X	TK 10029	✓	100	8	52	32	LNGX 1307	M4X14	T15
TK 10035	X	✓	125	10	62	40	LNGX 1307	M4X14	T15
TK 10031	X	✓	160	8	62	40	LNGX 1307	M4X14	T15

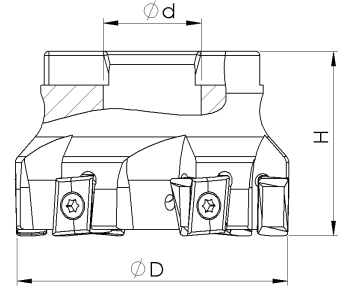

**90° LNHU 1306 WLTR**

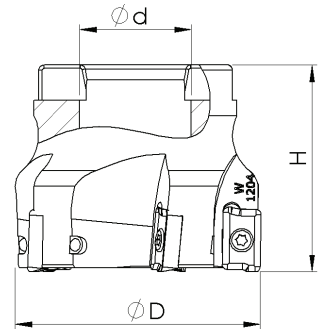

Kesici Uç Uyumluluğu Insert Suitability		Stok Stock	Takım Ölçüleri / Dimension (mm)				Uç Insert	Vida Screw	Anahtar Torx Key
90° LNHU 1306 WLTR			D	Z	H	d			
SİPARİŞ KODU Ordering Code	SİPARİŞ KODU Ordering Code Inter Coolant								
X	TK 10036	✓	40	4	40	16	LNHU 1306	M4X11	T15
X	TK 10037	✓	50	5	40	22	LNHU 1306	M4X11	T15
X	TK 10038	✓	63	6	40	22	LNHU 1306	M4X11	T15
X	TK 10039	✓	80	7	52	27	LNHU 1306	M4X11	T15
X	TK 10040	✓	100	9	52	32	LNHU 1306	M4X11	T15

**90° ADMT 1204 WLTR**



Kesici Uç Uyumluluğu Insert Suitability		Stok Stock	Takım Ölçüleri / Dimension (mm)				Uç Insert	Vida Screw	Anahtar Torx Key
90° ADMT 1204 WLTR			D	Z	H	d			
SİPARİŞ KODU Ordering Code	SİPARİŞ KODU Ordering Code Inter Coolant								
TK 9783	X	✓	40	4	40	16	ADMT 1204	M3X9	T10
TK 9784	X	✓	50	5	45	22	ADMT 1204	M3X9	T10
TK 9785	X	✓	63	6	45	22	ADMT 1204	M3X9	T10

## 90° P2840 WLTR

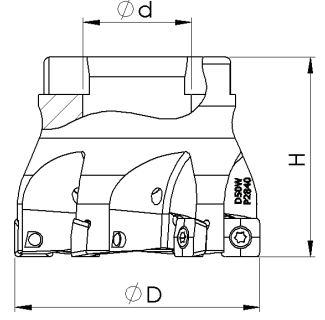

Kesici Uç Uyumluluğu Insert Suitability		Stok Stock	Takım Ölçüleri / Dimension (mm)				Uç Insert	Vida Screw	Anahtar Torx Key
90° P2840 WLTR			D	Z	H	d			
SİPARİŞ KODU Ordering Code	SİPARİŞ KODU Ordering Code Inter Cooland								
X	TK 10137	✓	40	4	40	16	P2840-63	M3,5X8	T15
X	TK 10138	✓	40	5	40	22	P2840-63	M3,5X8	T15

## 45° XNMU 0705 WLTR

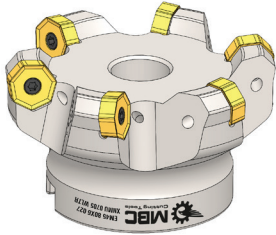

NEW

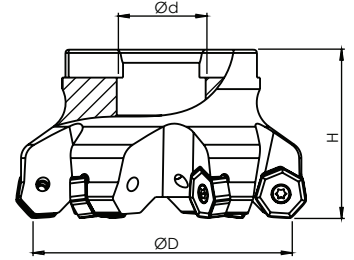

Kesici Uç Uyumluluğu Insert Suitability		Stok Stock	Takım Ölçüleri / Dimension (mm)				Uç Insert	Vida Screw	Anahtar Torx Key
XNMU 0705 WLTR			D	Z	H	d			
SİPARİŞ KODU Ordering Code	SİPARİŞ KODU Ordering Code Inter Cooland								
X	TK 14192	✓	63	5	40	22	XNMU 0705	M3,5X11	T15
X	TK 14193	✓	80	6	52	27	XNMU 0705	M3,5X11	T15
X	TK 14194	✓	100	7	52	32	XNMU 0705	M3,5X11	T15
X	TK 14195	✓	125	8	62	40	XNMU 0705	M3,5X11	T15

## 90° SPMT 1204 WLTR

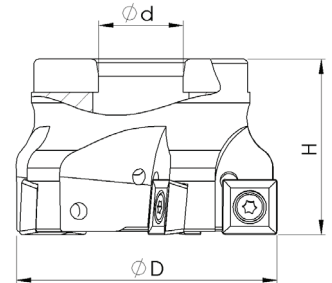

Kesici Uç Uyumluluğu Insert Suitability		Stok Stock	Takım Ölçüleri / Dimension (mm)				Uç Insert	Vida Screw	Anahtar Torx Key
90° SPMT 1204 WLTR			D	Z	H	d			
SİPARİŞ KODU Ordering Code	SİPARİŞ KODU Ordering Code Inter Cooland								
X	TK 10388	✓	50	4	45	22	SPMT 1204	M4,5X12	T20
X	TK 10389	✓	63	5	50	22	SPMT 1204	M4,5X12	T20

### 90° LNMX 1006 - 1510 KRLY

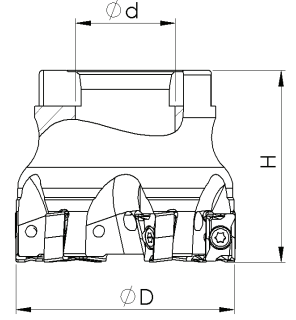

Kesici Uç Uyumluluğu Insert Suitability		Stok Stock	Takım Ölçüleri / Dimension (mm)				Uç Insert	Vida Screw	Anahtar Torx Key
SİPARİŞ KODU Ordering Code	SİPARİŞ KODU Ordering Code Inter Coolant		D	Z	H	d			
X	TK 10050	✓	40	4	40	16	LNMX 1006	M3X10	T10
X	TK 10052	✓	40	5	40	16	LNMX 1006	M3X10	T10
X	TK 10053	✓	50	6	40	22	LNMX 1006	M3X10	T10
X	TK 10055	✓	50	4	40	22	LNMX 1510	M4X14	T15
X	TK 10057	✓	63	6	40	22	LNMX 1510	M4X14	T15
X	TK 10059	✓	80	7	52	27	LNMX 1510	M4X14	T15
X	TK 10061	✓	100	8	52	32	LNMX 1510	M4X14	T15
TK 10063	X	✓	125	10	62	40	LNMX 1510	M4X14	T15
TK 10064	X	✓	160	12	62	40	LNMX 1510	M4X14	T15

### 90° XNKT 0805 KRLY

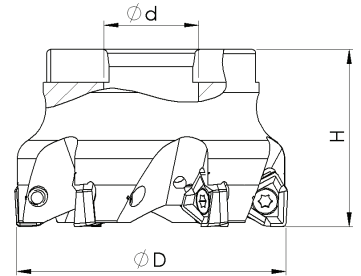
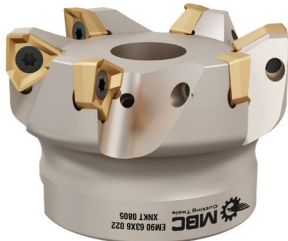

Kesici Uç Uyumluluğu Insert Suitability		Stok Stock	Takım Ölçüleri / Dimension (mm)				Uç Insert	Vida Screw	Anahtar Torx Key
SİPARİŞ KODU Ordering Code	SİPARİŞ KODU Ordering Code Inter Coolant		D	Z	H	d			
X	TK 10492	✓	40	4	40	16	XNKT 0805	M4X10	T15
X	TK 10493	✓	50	5	45	22	XNKT 0805	M4X10	T15
X	TK 10494	✓	63	6	45	22	XNKT 0805	M4X10	T15
X	TK 10495	✓	80	7	50	27	XNKT 0805	M4X10	T15
X	TK 10496	✓	100	8	50	32	XNKT 0805	M4X10	T15

## 90° APMT 11T3 KRLY

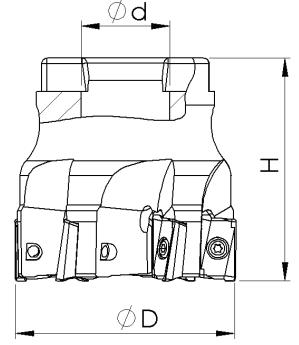

Kesici Uç Uyumluluğu Insert Suitability		Stok Stock	Takım Ölçüleri / Dimension (mm)				Uç İnsert	Vida Screw	Anahtar Torx Key
90° APMT 11T3 KRLY			D	Z	H	d			
SİPARİŞ KODU Ordering Code	SİPARİŞ KODU Ordering Code Inter Coolant								
X	TK 13063	✓	40	5	40	16	APMT 11T3	M2,5X7	T08
X	TK 11724	✓	40	6	40	16	APMT 11T3	M2,5X7	T08
X	TK 11725	✓	50	6	40	22	APMT 11T3	M2,5X7	T08
X	TK 11726	✓	63	7	40	22	APMT 11T3	M2,5X7	T08

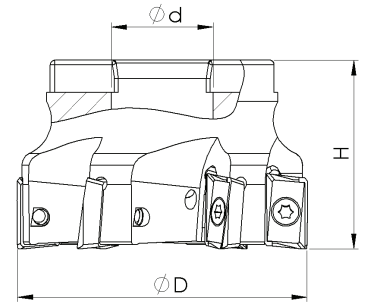
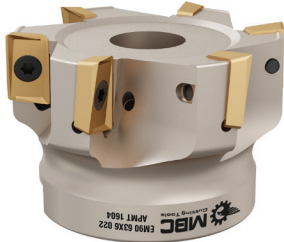

## 90° APMT 1604 KRLY



Kesici Uç Uyumluluğu Insert Suitability		Stok Stock	Takım Ölçüleri / Dimension (mm)				Uç İnsert	Vida Screw	Anahtar Torx Key
90° APMT 1604 KRLY			D	Z	H	d			
SİPARİŞ KODU Ordering Code	SİPARİŞ KODU Ordering Code Inter Coolant								
X	TK 11861	✓	50	5	40	22	APMT 1604	M4X15	T15
X	TK 11583	✓	63	6	40	22	APMT 1604	M4X15	T15
X	TK 11584	✓	80	7	40	27	APMT 1604	M4X15	T15
X	TK 11585	✓	100	8	52	32	APMT 1604	M4X15	T15

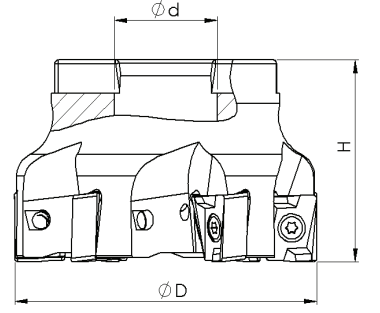

**90° LNGU 1607 PRMT**



Kesici Uç Uyumluluğu Insert Suitability		Stok Stock	Takım Ölçüleri / Dimension (mm)				Uç İnsert	Vida Screw	Anahtar Torx Key
SİPARİŞ KODU Ordering Code	SİPARİŞ KODU Ordering Code Inter Coolant		D	Z	H	d			
X	TK 10016	✓	63	5	40	22	LNGU 1607	M5X15	T20
X	TK 10014	✓	80	4	50	27	LNGU 1607	M5X15	T20
X	TK 10015	✓	100	5	50	32	LNGU 1607	M5X15	T20

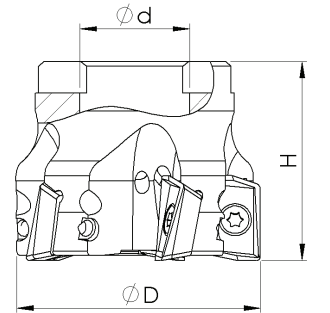

**90° ADMX 1606 PRMT**



Kesici Uç Uyumluluğu Insert Suitability		Stok Stock	Takım Ölçüleri / Dimension (mm)				Uç İnsert	Vida Screw	Anahtar Torx Key
SİPARİŞ KODU Ordering Code	SİPARİŞ KODU Ordering Code Inter Coolant		D	Z	H	d			
TK 9786	X	✓	50	4	40	22	ADMX 1606	M4X10	T15
TK 9787	X	✓	50	5	40	22	ADMX 1606	M4X10	T15
TK 9788	X	✓	80	7	50	27	ADMX 1606	M4X10	T15
TK 11222	X	✓	100	8	52	32	ADMX 1606	M4X10	T15

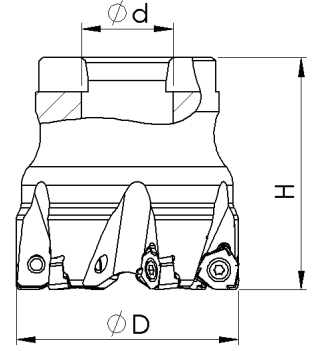

## 90° XNEX 0403 SCO - VNDRT

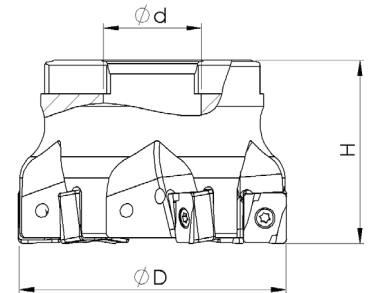
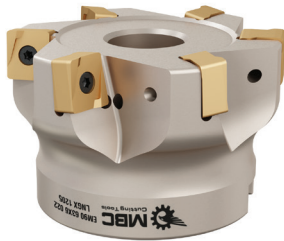

Kesici Uç Uyumluluğu Insert Suitability		Stok Stock	Takım Ölçüleri / Dimension (mm)				Uç Insert	Vida Screw	Anahtar Torx Key
SİPARİŞ KODU Ordering Code	SİPARİŞ KODU Ordering Code Inter Coolant		D	Z	H	d			
90° XNEX 0403 SCO - VNDRT									
TK 10480	x	✓	40	4	40	16	XNEX 0403	M2,5X7	T08
TK 10481	x	✓	50	7	40	22	XNEX 0403	M2,5X7	T08
TK 15430	x		63	7	40	22	XNEX 0403	M2,5X7	T08

## 90° LNGX 1205 VNDRT



Kesici Uç Uyumluluğu Insert Suitability		Stok Stock	Takım Ölçüleri / Dimension (mm)				Uç Insert	Vida Screw	Anahtar Torx Key
SİPARİŞ KODU Ordering Code	SİPARİŞ KODU Ordering Code Inter Coolant		D	Z	H	d			
90° LNGX 1205 VNDRT									
x	TK 10021	✓	40	4	40	16	LNGX 1205	M3,5X11	T15
x	TK 10022	✓	50	5	40	22	LNGX 1205	M3,5X11	T15
x	TK 10023	✓	63	6	40	22	LNGX 1205	M3,5X11	T15
x	TK 10024	✓	80	5	40	27	LNGX 1205	M3,5X11	T15

**90° ANHG 1005 VNDRT**

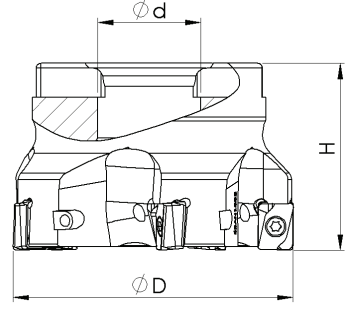

Kesici Uç Uyumluluğu Insert Suitability		Stok Stock	Takım Ölçüleri / Dimension (mm)				Uç Insert	Vida Screw	Anahtar Torx Key
90° ANHG 1005 VNDRT			D	Z	H	d			
SİPARİŞ KODU Ordering Code	SİPARİŞ KODU Ordering Code Inter Coolant								
X	TK 9805	✓	40	4	40	16	ANHG 1005	M3X10	T10
X	TK 9806	✓	50	5	40	22	ANHG 1005	M3X10	T10
X	TK 9807	✓	63	5	40	22	ANHG 1005	M3X10	T10
X	TK 9808	✓	63	7	40	22	ANHG 1005	M3X10	T10
X	TK 9810	✓	100	7	40	32	ANHG 1005	M3X10	T10
X	TK 9811	✓	100	8	40	32	ANHG 1005	M3X10	T10

**90° XNEX 0806 VNDRT**

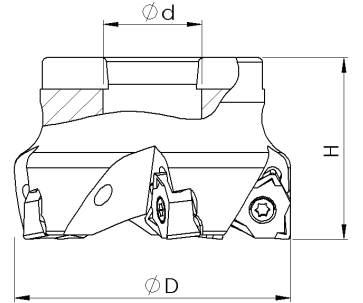

Kesici Uç Uyumluluğu Insert Suitability		Stok Stock	Takım Ölçüleri / Dimension (mm)				Uç Insert	Vida Screw	Anahtar Torx Key
90° XNEX 0806 VNDRT			D	Z	H	d			
SİPARİŞ KODU Ordering Code	SİPARİŞ KODU Ordering Code Inter Coolant								
X	TK 10483	✓	50	4	40	22	XNEX 0806	M4X11	T15
X	TK 10484	✓	63	5	40	22	XNEX 0806	M4X11	T15
X	TK 10485	✓	80	7	50	27	XNEX 0806	M4X11	T15
X	TK 10486	✓	100	8	62	32	XNEX 0806	M4X11	T15
TK 10482	X	✓	160	12	62	40	XNEX 0806	M4X11	T15

## 90° ANHG 1607 VNDRT

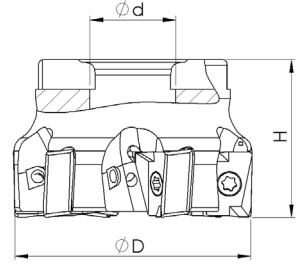

Kesici Uç Uyumluluğu Insert Suitability		Stok Stock	Takım Ölçüleri / Dimension (mm)				Uç Insert	Vida Screw	Anahtar Torx Key
90° ANHG 1607 VNDRT			D	Z	H	d			
SİPARİŞ KODU Ordering Code	SİPARİŞ KODU Ordering Code Inter Coolant								
X	TK 9812	✓	50	4	40	22	ANHG 1607	M4X14	T15
X	TK 9813	✓	63	4	40	22	ANHG 1607	M4X14	T15
X	TK 9814	✓	63	6	40	22	ANHG 1607	M4X14	T15
X	TK 9815	✓	80	5	50	27	ANHG 1607	M4X14	T15
X	TK 9816	✓	80	7	50	27	ANHG 1607	M4X14	T15
X	TK 11223	✓	100	8	50	32	ANHG 1607	M4X14	T15

## 90° ANHX 1607 TT

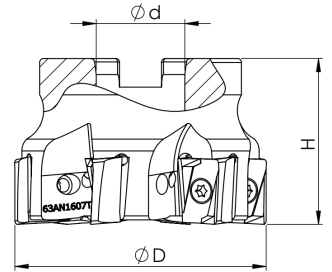

Kesici Uç Uyumluluğu Insert Suitability		Stok Stock	Takım Ölçüleri / Dimension (mm)				Uç Insert	Vida Screw	Anahtar Torx Key
90° ANHX 1607 TT			D	Z	H	d			
SİPARİŞ KODU Ordering Code	SİPARİŞ KODU Ordering Code Inter Coolant								
X	TK 12809	✓	50	5	40	22	ANHX 1607	M4X14	T15
X	TK 12810	✓	63	6	40	22	ANHX 1607	M4X14	T15
X	TK 12811	✓	80	7	50	27	ANHX 1607	M4X14	T15
X	TK 12688	✓	100	8	50	32	ANHX 1607	M4X14	T15

**90° XOMX 1204 SCO**

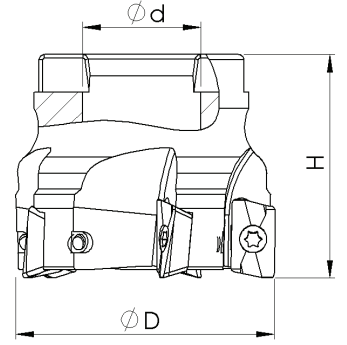

Kesici Uç Uyumluluğu Insert Suitability		Stok Stock	Takım Ölçüleri / Dimension (mm)				Uç Insert	Vida Screw	Anahtar Torx Key
SIPARIŞ KODU Ordering Code	SIPARIŞ KODU Ordering Code Inter Coolant		D	Z	H	d			
90° XOMX 1204 SCO									
TK 10497	X	✓	40	4	40	16	XOMX 1204	M3,5X11X4.80	T15
TK 10498	X	✓	50	5	40	22	XOMX 1204	M3,5X11X4.80	T15
TK 10499	X	✓	63	6	40	22	XOMX 1204	M3,5X11X4.80	T15
TK 10500	X	✓	80	8	50	27	XOMX 1204	M3,5X11X4.80	T15

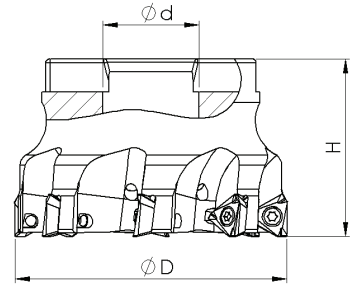
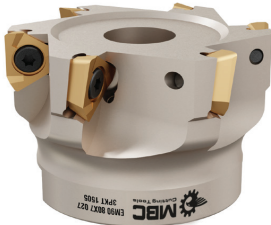

**90° 3PKT 1505 TT**



Kesici Uç Uyumluluğu Insert Suitability		Stok Stock	Takım Ölçüleri / Dimension (mm)				Uç Insert	Vida Screw	Anahtar Torx Key
SIPARIŞ KODU Ordering Code	SIPARIŞ KODU Ordering Code Inter Coolant		D	Z	H	d			
90° 3PKT 1505 TT									
X	TK 14127	✓	50	4	40	22	3PKT 1505	M4,5X12	T20
X	TK 14128	✓	63	5	40	22	3PKT 1505	M4,5X12	T20
X	TK 14129	✓	80	7	50	27	3PKT 1505	M4,5X12	T20
X	TK 14130	✓	100	8	50	32	3PKT 1505	M4,5X12	T20

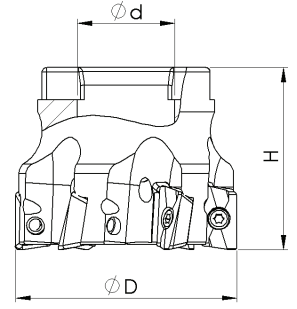

## 90° APKT 1204 TT

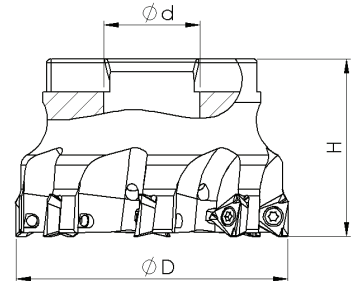
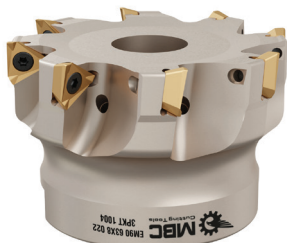

Kesici Uç Uyumluluğu Insert Suitability			Stok Stock	Takım Ölçüleri / Dimension (mm)				Uç Insert	Vida Screw	Anahtar Torx Key
90° APKT 1204 TT		SIPARIŞ KODU Ordering Code		SIPARIŞ KODU Ordering Code Inter Coolant	D	Z	H	d		
X	TK 9859		✓							
X	TK 9860	✓		50	6	40	22	APKT 1204	M3,5X10	T15
X	TK 9861	✓		63	7	40	22	APKT 1204	M3,5X10	T15
X	TK 9862	✓		80	8	52	27	APKT 1204	M3,5X10	T15

## 90° 3PKT 1004 TT



Kesici Uç Uyumluluğu Insert Suitability			Stok Stock	Takım Ölçüleri / Dimension (mm)				Uç Insert	Vida Screw	Anahtar Torx Key
90° 3PKT 1004 TT		SIPARIŞ KODU Ordering Code		SIPARIŞ KODU Ordering Code Inter Coolant	D	Z	H	d		
X	TK 9713		✓							
X	TK 9714	✓		50	5	40	22	3PKT 1004	M3X8	T10
X	TK 9715	✓		63	8	40	22	3PKT 1004	M3X8	T10

**90° APMT 1135 TT**

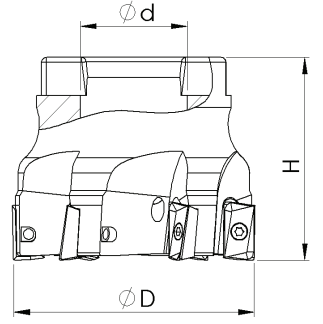

Kesici Uç Uyumluluğu Insert Suitability		Stok Stock	Takım Ölçüleri / Dimension (mm)				Uç Insert	Vida Screw	Anahtar Torx Key
90° APMT 1135 TT			D	Z	H	d			
SİPARİŞ KODU Ordering Code	SİPARİŞ KODU Ordering Code Inter Coolant								
X	TK 14331	✓	40	5	40	16	APMT 1135	M2,5X7	T08
X	TK 14332	✓	50	6	40	22	APMT 1135	M2,5X7	T08
X	TK 14333	✓	63	7	40	22	APMT 1135	M2,5X7	T08

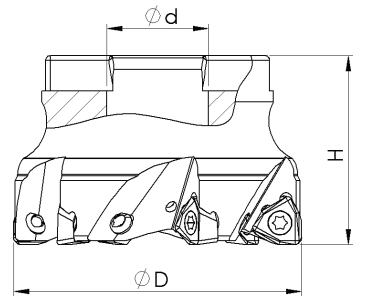

**90° 6NGU 0604 TT**



Kesici Uç Uyumluluğu Insert Suitability		Stok Stock	Takım Ölçüleri / Dimension (mm)				Uç Insert	Vida Screw	Anahtar Torx Key
90° 6NGU 0604 TT			D	Z	H	d			
SİPARİŞ KODU Ordering Code	SİPARİŞ KODU Ordering Code Inter Coolant								
X	TK 11547	✓	40	4	40	16	6NGU 0604	M3X8	T10
X	TK 11607	✓	50	5	40	22	6NGU 0604	M3X8	T10
X	TK 11608	✓	63	6	40	22	6NGU 0604	M3X8	T10

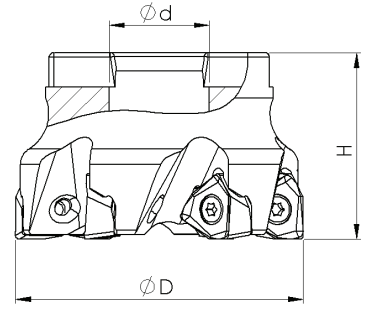

## 90° 6NGU 0905 TT

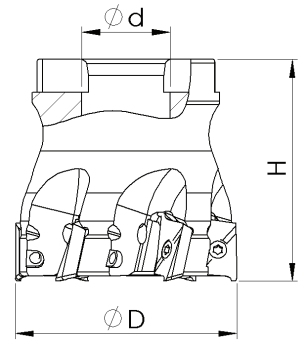

Kesici Uç Uyumluluğu Insert Suitability		Stok Stock	Takım Ölçüleri / Dimension (mm)				Uç Insert	Vida Screw	Anahtar Torx Key
90° 6NGU 0905 TT			D	Z	H	d			
SİPARİŞ KODU Ordering Code	SİPARİŞ KODU Ordering Code Inter Coolant								
X	TK 9716	✓	50	5	40	22	6NGU 0905	M4X11	T15
X	TK 9717	✓	63	6	40	22	6NGU 0905	M4X11	T15
X	TK 9718	✓	80	7	50	27	6NGU 0905	M4X11	T15
X	TK 9719	✓	100	8	50	32	6NGU 0905	M4X11	T15
TK 9720	X	✓	125	10	62	40	6NGU 0905	M4X11	T15

## 90° AOMT 1236 MTSBSH



Kesici Uç Uyumluluğu Insert Suitability		Stok Stock	Takım Ölçüleri / Dimension (mm)				Uç Insert	Vida Screw	Anahtar Torx Key
90° AOMT 1236 MTSBSH			D	Z	H	d			
SİPARİŞ KODU Ordering Code	SİPARİŞ KODU Ordering Code Inter Coolant								
X	TK 9827	✓	40	6	40	16	AOMT 1236	M2,5X7	T08
X	TK 9828	✓	50	7	40	22	AOMT 1236	M2,5X7	T08
X	TK 9829	✓	63	8	40	22	AOMT 1236	M2,5X7	T08
X	TK 9830	✓	80	9	40	27	AOMT 1236	M2,5X7	T08

**90° SOMT 12T3 MTSBSH**

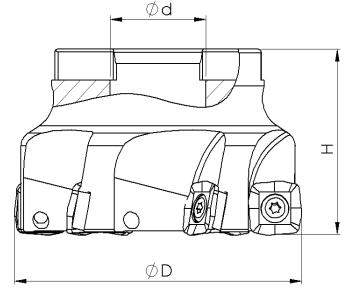
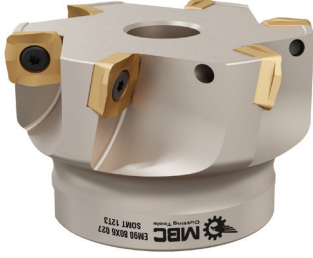

Kesici Uç Uyumluluğu Insert Suitability		Stok Stock	Takım Ölçüleri / Dimension (mm)				Uç Insert	Vida Screw	Anahtar Torx Key
90° SOMT 12T3 MTSBSH			D	Z	H	d			
SİPARİŞ KODU Ordering Code	SİPARİŞ KODU Ordering Code Inter Coolant								
X	TK 10370	✓	50	4	40	22	SOMT 12T3	M3,5X11	T15
X	TK 10371	✓	63	5	45	22	SOMT 12T3	M3,5X11	T15
X	TK 10372	✓	80	6	45	27	SOMT 12T3	M3,5X11	T15
X	TK 10373	✓	100	7	50	32	SOMT 12T3	M3,5X11	T15

**90° AOMT 1848 MTSBSH**

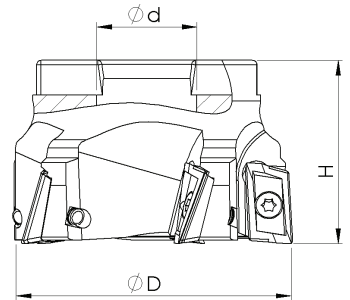
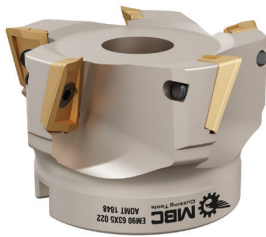

Kesici Uç Uyumluluğu Insert Suitability		Stok Stock	Takım Ölçüleri / Dimension (mm)				Uç Insert	Vida Screw	Anahtar Torx Key
90° AOMT 1848 MTSBSH			D	Z	H	d			
SİPARİŞ KODU Ordering Code	SİPARİŞ KODU Ordering Code Inter Coolant								
TK 9836	X	✓	50	4	40	22	AOMT 1848	M4X11	T15
TK 9837	X	✓	63	5	40	22	AOMT 1848	M4X11	T15
TK 9838	X	✓	80	6	52	27	AOMT 1848	M4X11	T15
TK 9839	X	✓	100	8	52	32	AOMT 1848	M4X11	T15

## 90° XDGT 1550 MTSBSH

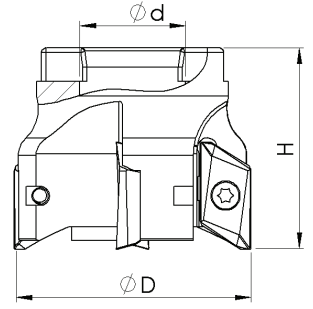

Kesici Uç Uyumluluğu Insert Suitability		Stok Stock	Takım Ölçüleri / Dimension (mm)				Uç İnsert	Vida Screw	Anahtar Torx Key
90° XDGT 1550 MTSBSH	SIPARIŞ KODU Ordering Code		SIPARIŞ KODU Ordering Code	D	Z	H	d		
X	TK 10474	✓	50	4	40	22	XDGT 1550	M4X11	T15
X	TK 10475	✓	63	5	40	22	XDGT 1550	M4X11	T15

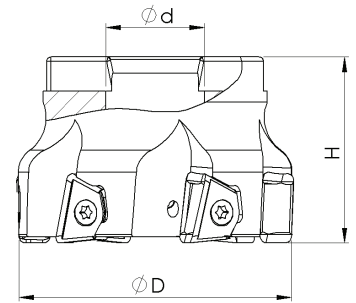
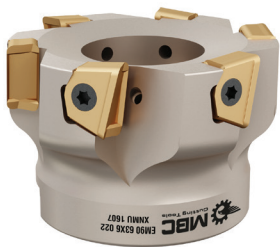

## 90° XNMU 1607 MTSBSH



Kesici Uç Uyumluluğu Insert Suitability		Stok Stock	Takım Ölçüleri / Dimension (mm)				Uç İnsert	Vida Screw	Anahtar Torx Key
90° XNMU 1607 MTSBSH	SIPARIŞ KODU Ordering Code		SIPARIŞ KODU Ordering Code	D	Z	H	d		
X	TK 11316	✓	50	5	40	22	XNMU 1607	M4X11	T15
X	TK 11317	✓	63	6	40	22	XNMU 1607	M4X11	T15
X	TK 11318	✓	80	7	52	27	XNMU 1607	M4X11	T15

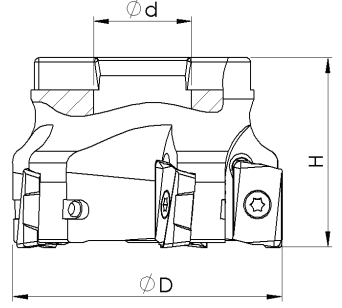
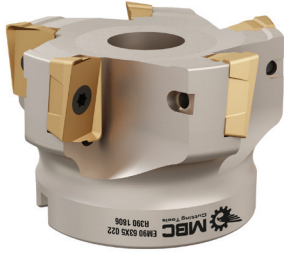

**90° R390 1806 SNDVK**

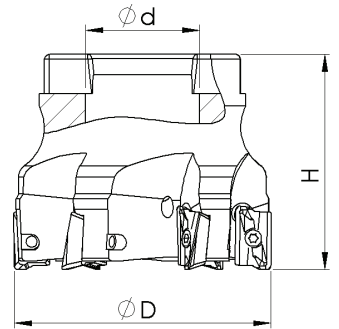

Kesici Uç Uyumluluğu Insert Suitability			Stok Stock	Takım Ölçüleri / Dimension (mm)				Uç Insert	Vida Screw	Anahtar Torx Key
90° R390 1806 SNDVK				D	Z	H	d			
SİPARİŞ KODU Ordering Code	SİPARİŞ KODU Ordering Code Inter Coolant									
TK 10155	X	✓	50	4	40	22	R390 1806	M4X11	T15	
TK 10156	X	✓	63	5	40	22	R390 1806	M4X11	T15	
TK 10157	X	✓	80	6	40	27	R390 1806	M4X11	T15	
TK 10158	X	✓	100	8	52	32	R390 1806	M4X11	T15	
TK 10160	X	✓	125	9	62	40	R390 1806	M4X11	T15	
TK 10159	X	✓	160	10	52	40	R390 1806	M4X11	T15	

**90° R390 11T3 SNDVK**



Kesici Uç Uyumluluğu Insert Suitability			Stok Stock	Takım Ölçüleri / Dimension (mm)				Uç Insert	Vida Screw	Anahtar Torx Key
90° R390 11T3 SNDVK				D	Z	H	d			
SİPARİŞ KODU Ordering Code	SİPARİŞ KODU Ordering Code Inter Coolant									
X	TK 11548	✓	40	5	40	16	R390 11T3	M2,5X7	T08	
X	TK 11549	✓	50	6	40	22	R390 11T3	M2,5X7	T08	
X	TK 11727	✓	63	7	50	22	R390 11T3	M2,5X7	T08	

## 90° ADKT 1704 SNDVK

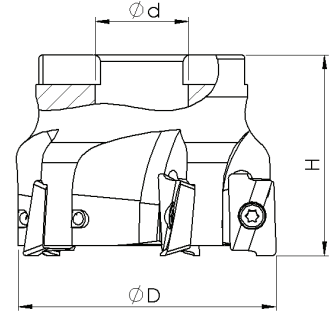
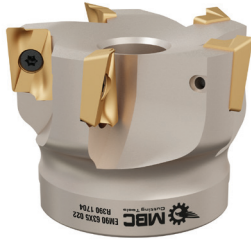

Kesici Uç Uyumluluğu Insert Suitability		Stok Stock	Takım Ölçüleri / Dimension (mm)				Uç Insert	Vida Screw	Anahtar Torx Key
90° ADKT 1704 SNDVK			D	Z	H	d			
SİPARİŞ KODU Ordering Code	SİPARİŞ KODU Ordering Code Inter Coolant								
TK 9776	X	✓	40	4	40	16	R390 1704	M3,5X11	T15
TK 9777	X	✓	50	4	45	22	R390 1704	M3,5X11	T15
TK 9778	X	✓	63	5	45	22	R390 1704	M3,5X11	T15
TK 9779	X	✓	80	6	52	27	R390 1704	M3,5X11	T15

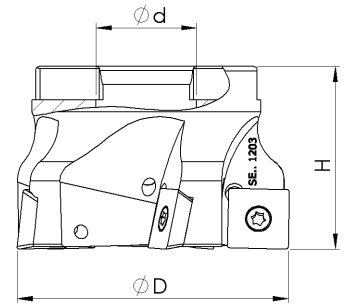
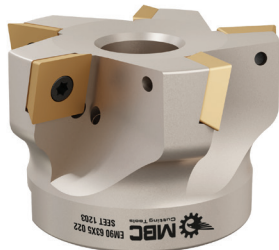

## 90° SEET 1203 ZCC - SNDVK



Kesici Uç Uyumluluğu Insert Suitability		Stok Stock	Takım Ölçüleri / Dimension (mm)				Uç Insert	Vida Screw	Anahtar Torx Key
90° SEET 1203 ZCC - SNDVK			D	Z	H	d			
SİPARİŞ KODU Ordering Code	SİPARİŞ KODU Ordering Code Inter Coolant								
X	TK 10286	✓	50	4	40	22	SEET 1203	M3,5X11	T15
X	TK 10287	✓	63	5	40	22	SEET 1203	M3,5X11	T15
X	TK 10288	✓	80	6	50	27	SEET 1203	M3,5X11	T15
X	TK 10289	✓	100	7	50	32	SEET 1203	M3,5X11	T15
TK 10290	X	✓	125	8	62	40	SEET 1203	M3,5X11	T15
TK 12605	X	✓	160	12	62	40	SEET 1203	M3,5X11	T15

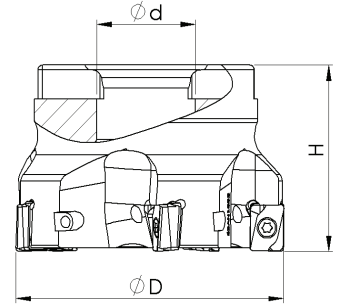
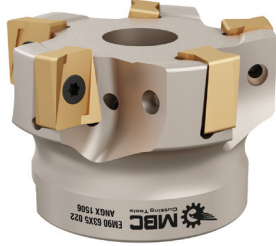

**90° ANGX 1506 ZCC**



Kesici Uç Uyumluluğu Insert Suitability		Stok Stock	Takım Ölçüleri / Dimension (mm)				Uç Insert	Vida Screw	Anahtar Torx Key
90° ANGX 1506 ZCC			D	Z	H	d			
SİPARİŞ KODU Ordering Code	SİPARİŞ KODU Ordering Code Inter Coolant								
X	TK 12812	✓	40	4	45	16	ANGX 1506	M4X14	T15
X	TK 9801	✓	50	4	45	22	ANGX 1506	M4X14	T15
X	TK 9802	✓	63	5	45	22	ANGX 1506	M4X14	T15
X	TK 9803	✓	80	6	50	27	ANGX 1506	M4X14	T15
X	TK 9804	✓	100	8	55	32	ANGX 1506	M4X14	T15
TK 12445	X	✓	125	9	62	40	ANGX 1506	M4X14	T15
TK 12603	X	✓	160	10	62	40	ANGX 1506	M4X14	T15
TK 12266	X	✓	200	14	62	60	ANGX 1506	M4X14	T15

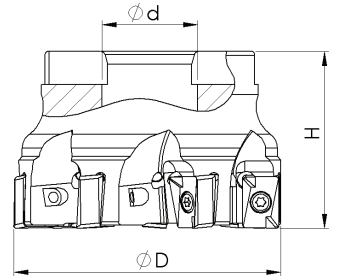

**90° ANGX 1105 ZCC**



Kesici Uç Uyumluluğu Insert Suitability		Stok Stock	Takım Ölçüleri / Dimension (mm)				Uç Insert	Vida Screw	Anahtar Torx Key
90° ANGX 1105 ZCC			D	Z	H	d			
SİPARİŞ KODU Ordering Code	SİPARİŞ KODU Ordering Code Inter Coolant								
X	TK 12338	✓	40	4	40	16	ANGX 1105	M3X9	T10
X	TK 9799	✓	50	6	40	22	ANGX 1105	M3X9	T10
X	TK 9800	✓	63	7	40	22	ANGX 1105	M3X9	T10

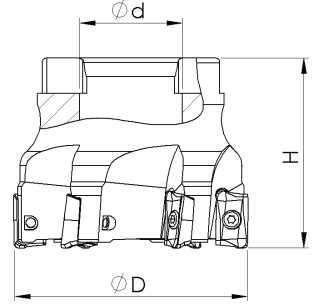

## 90° APKT 11T3 ZCC

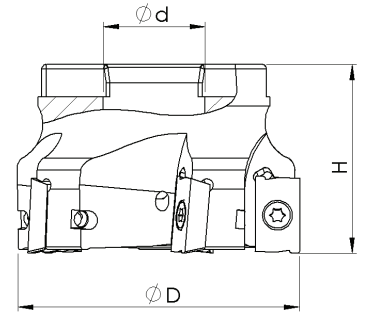
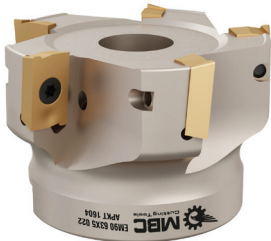

Kesici Uç Uyumluluğu Insert Suitability		Stok Stock	Takım Ölçüleri / Dimension (mm)				Uç Insert	Vida Screw	Anahtar Torx Key
90° APKT 11T3 ZCC			D	Z	H	d			
SİPARİŞ KODU Ordering Code	SİPARİŞ KODU Ordering Code Inter Cooland								
X	TK 9856	✓	40	5	45	16	APKT 11T3	M2,5X7	T08
X	TK 9857	✓	50	6	50	22	APKT 11T3	M2,5X7	T08
X	TK 9721	✓	63	7	50	22	APKT 11T3	M2,5X7	T08

## 90° APKT 1604 ZCC



Kesici Uç Uyumluluğu Insert Suitability		Stok Stock	Takım Ölçüleri / Dimension (mm)				Uç Insert	Vida Screw	Anahtar Torx Key
90° APKT 1604 ZCC			D	Z	H	d			
SİPARİŞ KODU Ordering Code	SİPARİŞ KODU Ordering Code Inter Cooland								
TK 9893	X	✓	40	4	40	16	APKT 1604	M4X11	T15
TK 9895	X	✓	50	5	40	22	APKT 1604	M4X11	T15
TK 9897	X	✓	63	5	40	22	APKT 1604	M4X11	T15
TK 11557	X	✓	80	7	50	27	APKT 1604	M4X11	T15
TK 12430	X	✓	100	8	50	32	APKT 1604	M4X11	T15
TK 12431	X	✓	125	9	62	40	APKT 1604	M4X11	T15

### 90° WNHU 0806 ZCC

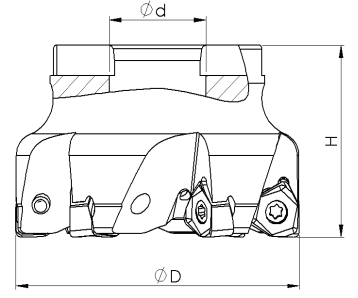

Kesici Uç Uyumluluğu Insert Suitability		Stok Stock	Takım Ölçüleri / Dimension (mm)				Uç Insert	Vida Screw	Anahtar Torx Key
SIPARIŞ KODU Ordering Code	SIPARIŞ KODU Ordering Code Inter Coolant		D	Z	H	d			
X	TK 10433	✓	50	4	40	22	WNHU 0806	M4X11	T15
X	TK 10434	✓	63	5	40	22	WNHU 0806	M4X11	T15
X	TK 11933	✓	63	6	40	22	WNHU 0806	M4X11	T15
X	TK 14139	✓	80	5	50	27	WNHU 0806	M4X11	T15
X	TK 10435	✓	80	6	50	27	WNHU 0806	M4X11	T15
X	TK 11934	✓	100	8	50	32	WNHU 0806	M4X11	T15
TK 10438	X	✓	250	16	62	60	WNHU 0806	M4X11	T15

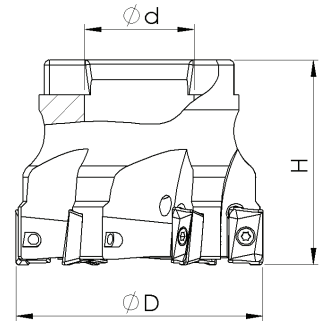

### 90° APKT 10T3 ZCC



Kesici Uç Uyumluluğu Insert Suitability		Stok Stock	Takım Ölçüleri / Dimension (mm)				Uç Insert	Vida Screw	Anahtar Torx Key
SIPARIŞ KODU Ordering Code	SIPARIŞ KODU Ordering Code Inter Coolant		D	Z	H	d			
TK 9885	X	✓	40	5	40	16	APKT 10T3	M2,5X7	T08
TK 9887	X	✓	50	6	40	22	APKT 10T3	M2,5X7	T08
TK 9889	X	✓	63	7	40	22	APKT 10T3	M2,5X7	T08

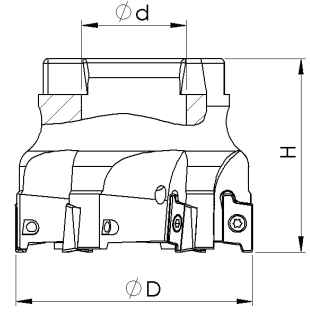

## 90° APLX 1008 ZCC

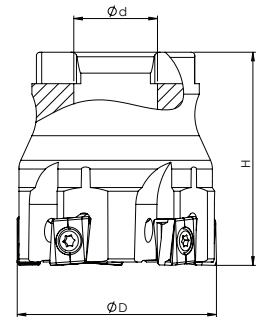

Kesici Uç Uyumluluğu Insert Suitability		Stok Stock	Takım Ölçüleri / Dimension (mm)				Uç Insert	Vida Screw	Anahtar Torx Key
90° APLX 1008 ZCC			D	Z	H	d			
SİPARİŞ KODU R Ordering Code	SİPARİŞ KODU Ordering Code Inter Coolant								
TK 9902	X	✓	40	5	40	16	APLX 1008	M2,5X7	T08
TK 9903	X	✓	50	6	40	22	APLX 1008	M2,5X7	T08
TK 9904	X	✓	63	7	40	22	APLX 1008	M2,5X7	T08

## 90° LNKT 0804 ZCC



Kesici Uç Uyumluluğu Insert Suitability		Stok Stock	Takım Ölçüleri / Dimension (mm)				Uç Insert	Vida Screw	Anahtar Torx Key
90° LNKT 0804 ZCC			D	Z	H	d			
SİPARİŞ KODU R Ordering Code	SİPARİŞ KODU Ordering Code Inter Coolant								
X	TK 11453	✓	40	5	40	16	LNKT 0804	M3X10	T10

### 90° LNKT 1206 ZCC

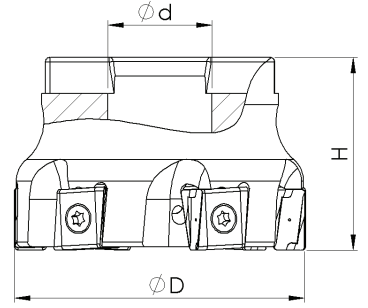

Kesici Uç Uyumluluğu Insert Suitability		Stok Stock	Takım Ölçüleri / Dimension (mm)				Uç Insert	Vida Screw	Anahtar Torx Key
90° LNKT 1206 ZCC			D	Z	H	d			
SİPARİŞ KODU Ordering Code	SİPARİŞ KODU Ordering Code Inter Coolant								
X	TK 11442	✓	50	5	40	22	LNKT 1206	M4X11	T15
X	TK 11449	✓	63	6	40	22	LNKT 1206	M4X11	T15
X	TK 11450	✓	80	7	50	27	LNKT 1206	M4X11	T15
X	TK 11451	✓	100	9	50	32	LNKT 1206	M4X11	T15
TK 11452	X	✓	125	11	62	40	LNKT 1206	M4X11	T15

### 90° EDPT 10T3 KNMTL



NEW

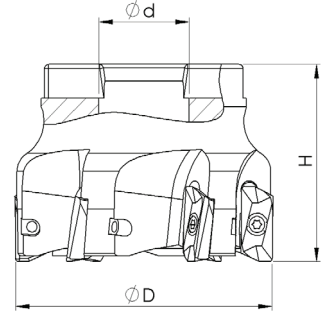

Kesici Uç Uyumluluğu Insert Suitability		Stok Stock	Takım Ölçüleri / Dimension (mm)				Uç Insert	Vida Screw	Anahtar Torx Key
90° EDPT 10T3 KNMTL			D	Z	H	d			
SİPARİŞ KODU Ordering Code	SİPARİŞ KODU Ordering Code Inter Coolant								
TK 16469	X	✓	40	5	40	16	EDPT 10T3	M2,5X7	T8
TK 16470	X	✓	50	6	40	22	EDPT 10T3	M2,5X7	T8
TK 16471	X	✓	63	7	40	22	EDPT 10T3	M2,5X7	T8

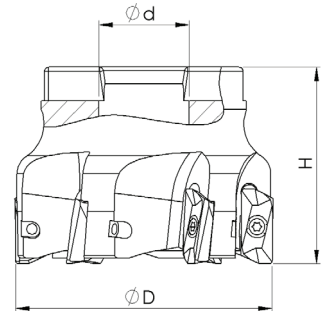

### 90° EDPT 1404 - 1805 KNMTL



Kesici Uç Uyumluluğu Insert Suitability		Stok Stock	Takım Ölçüleri / Dimension (mm)				Uç Insert	Vida Screw	Anahtar Torx Key
90° EDPT 1404 - 1805 KNMTL			D	Z	H	d			
SİPARİŞ KODU Ordering Code	SİPARİŞ KODU Ordering Code Inter Coolant								
TK 9945	X	✓	40	4	40	16	EDPT 1404	M3X8	T10
TK 9946	X	✓	50	5	40	22	EDPT 1404	M3X8	T10
TK 9947	X	✓	63	6	50	22	EDPT 1404	M3X8	T10
TK 9948	X	✓	80	7	50	27	EDPT 1404	M3X8	T10
TK 9949	X	✓	100	8	50	32	EDPT 1404	M3X8	T10
TK 9950	X	✓	50	4	40	22	EDPT 1805	M3,5X10	T15
TK 9951	X	✓	63	5	50	22	EDPT 1805	M3,5X10	T15
TK 9952	X	✓	80	6	50	27	EDPT 1805	M3,5X10	T15

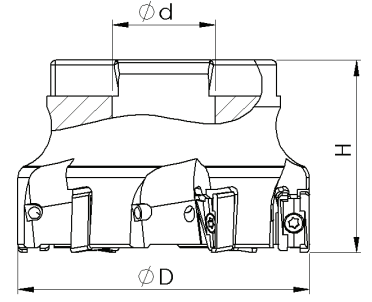

## 90° LNGU 1104 KNMTL

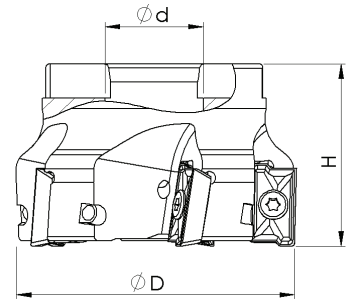
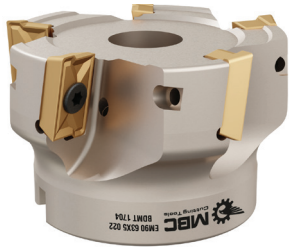

Kesici Uç Uyumluluğu Insert Suitability		Stok Stock	Takım Ölçüleri / Dimension (mm)				Uç Insert	Vida Screw	Anahtar Torx Key
90° LNGU 1104 KNMTL			D	Z	H	d			
SİPARİŞ KODU Ordering Code	SİPARİŞ KODU Ordering Code Inter Cooland								
X	TK 11610	✓	40	5	40	16	LNGU 1104	M3X8	T10
X	TK 12687	✓	50	6	40	22	LNGU 1104	M3X8	T10
X	TK 11612	✓	63	6	40	22	LNGU 1104	M3X8	T10
X	TK 11613	✓	80	7	50	27	LNGU 1104	M3X8	T10

## 90° BDMT 1704 KYCR



Kesici Uç Uyumluluğu Insert Suitability		Stok Stock	Takım Ölçüleri / Dimension (mm)				Uç Insert	Vida Screw	Anahtar Torx Key
90° BDMT 1704 KYCR			D	Z	H	d			
SİPARİŞ KODU Ordering Code	SİPARİŞ KODU Ordering Code Inter Cooland								
X	TK 9929	✓	40	4	40	16	BDMT 1704	M4X11	T15
X	TK 9930	✓	50	5	40	22	BDMT 1704	M4X11	T15
X	TK 9932	✓	80	6	50	27	BDMT 1704	M4X11	T15

## 90° LOMU 1004 KYCR

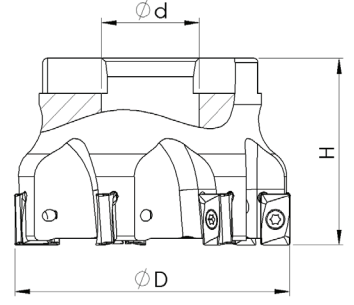

Kesici Uç Uyumluluğu Insert Suitability		Stok Stock	Takım Ölçüleri / Dimension (mm)				Uç Insert	Vida Screw	Anahtar Torx Key
90° LOMU 1004 KYCR			D	Z	H	d			
SİPARİŞ KODU Ordering Code	SİPARİŞ KODU Ordering Code Inter Coolant								
X	TK 11226	✓	40	5	40	16	LOMU 1004	M3X8	T10
X	TK 10075	✓	50	6	45	22	LOMU 1004	M3X8	T10
X	TK 10073	✓	63	7	50	22	LOMU 1004	M3X8	T10
X	TK 10074	✓	80	8	50	27	LOMU 1004	M3X8	T10

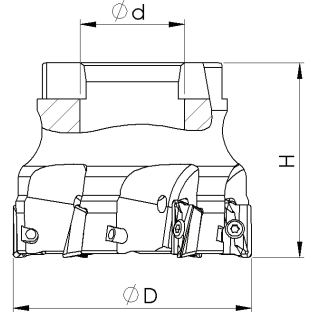

## 90° BDMT 11T3 KYCR



Kesici Uç Uyumluluğu Insert Suitability		Stok Stock	Takım Ölçüleri / Dimension (mm)				Uç Insert	Vida Screw	Anahtar Torx Key
90° BDMT 11T3 KYCR			D	Z	H	d			
SİPARİŞ KODU Ordering Code	SİPARİŞ KODU Ordering Code Inter Coolant								
X	TK 9927	✓	40	5	40	16	BDMT 11T3	M2,5X7	T08
X	TK 9928	✓	50	6	40	22	BDMT 11T3	M2,5X7	T08

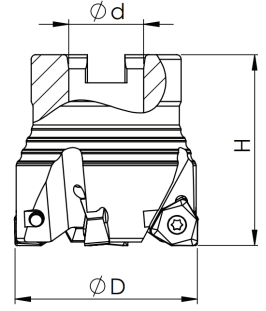

## 90° WNMU 0504 KYCR

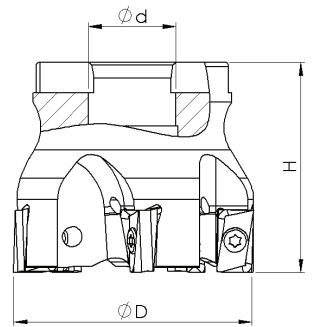

Kesici Uç Uyumluluğu Insert Suitability		Stok Stock	Takım Ölçüleri / Dimension (mm)				Uç İnsert	Vida Screw	Anahtar Torx Key
SİPARİŞ KODU Ordering Code	SİPARİŞ KODU Ordering Code Inter Coolant		D	Z	H	d			
X	TK 11991	✓	40	4	40	16	WNMU 0504	M3X8	T10
X	TK 11992	✓	50	4	40	22	WNMU 0504	M3X8	T10

## 90° LOMU 1505 KYCR



Kesici Uç Uyumluluğu Insert Suitability		Stok Stock	Takım Ölçüleri / Dimension (mm)				Uç İnsert	Vida Screw	Anahtar Torx Key
SİPARİŞ KODU Ordering Code	SİPARİŞ KODU Ordering Code Inter Coolant		D	Z	H	d			
X	TK 10076	✓	50	4	40	22	LOMU 1505	M4X15	T15
X	TK 10077	✓	63	5	40	22	LOMU 1505	M4X15	T15
TK 11227	X	✓	160	12	62	40	LOMU 1505	M4X15	T15
TK 10079	X	✓	200	14	62	60	LOMU 1505	M4X15	T15

### 90° WNMU 0806 KYCR

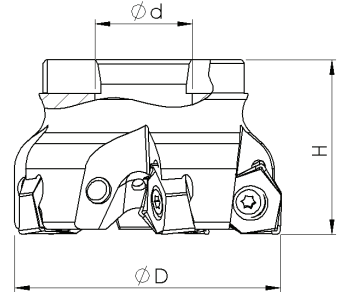
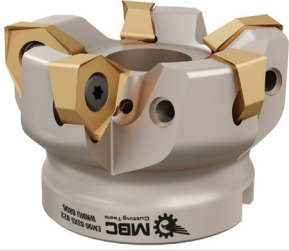

Kesici Uç Uyumluluğu Insert Suitability		Stok Stock	Takım Ölçüleri / Dimension (mm)				Uç Insert	Vida Screw	Anahtar Torx Key
SİPARİŞ KODU Ordering Code	SİPARİŞ KODU Ordering Code Inter Coolant		D	Z	H	d			
X	TK 10439	✓	50	4	40	22	WNMU 0806	M5X12	T20
X	TK 10441	✓	52	4	40	22	WNMU 0806	M5X12	T20
X	TK 10445	✓	63	5	40	22	WNMU 0806	M5X12	T20
X	TK 10449	✓	80	6	45	27	WNMU 0806	M5X12	T20
X	TK 10451	✓	100	7	50	32	WNMU 0806	M5X12	T20
TK 10453	X	✓	125	8	50	40	WNMU 0806	M5X12	T20
TK 10454	X	✓	160	10	62	40	WNMU 0806	M5X12	T20
TK 10456	X	✓	200	12	62	60	WNMU 0806	M5X12	T20

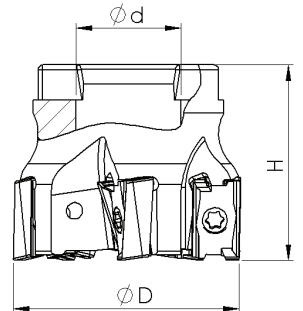

### 90° XNGU 15T6 WDA



Kesici Uç Uyumluluğu Insert Suitability		Stok Stock	Takım Ölçüleri / Dimension (mm)				Uç Insert	Vida Screw	Anahtar Torx Key
SİPARİŞ KODU Ordering Code	SİPARİŞ KODU Ordering Code Inter Coolant		D	Z	H	d			
X	TK 10487	✓	40	4	40	16	XNGU 15T6	M4X14	T15
X	TK 10491	✓	50	4	40	22	XNGU 15T6	M4X14	T15
X	TK 10488	✓	50	5	40	22	XNGU 15T6	M4X14	T15
X	TK 10489	✓	63	5	40	22	XNGU 15T6	M4X14	T15
X	TK 10490	✓	80	6	50	27	XNGU 15T6	M4X14	T15

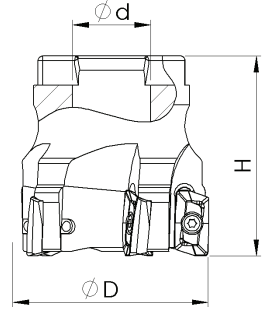

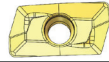
## 90° XDPT 1104 - 1704 WDA

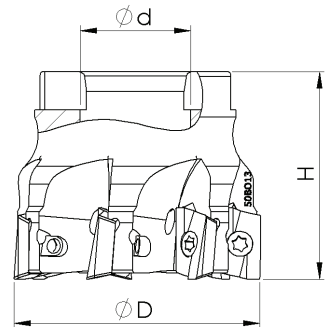
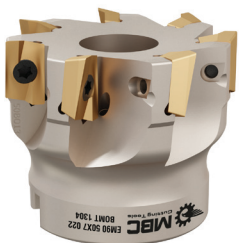

Kesici Uç Uyumluluğu Insert Suitability		Stok Stock	Takım Ölçüleri / Dimension (mm)				Uç Insert	Vida Screw	Anahtar Torx Key
SİPARİŞ KODU Ordering Code	SİPARİŞ KODU Ordering Code Inter Coolant		D	Z	H	d			
x	TK 11571	✓	40	5	40	16	XDPT 1104	M2,5X7	T08
x	TK 11731	✓	50	6	40	22	XDPT 1104	M2,5X7	T08
x	TK 11569	✓	63	6	40	22	XDPT 1704	M4X11	T15

## 90° BOMT 1304 INGRSL



Kesici Uç Uyumluluğu Insert Suitability		Stok Stock	Takım Ölçüleri / Dimension (mm)				Uç Insert	Vida Screw	Anahtar Torx Key
SİPARİŞ KODU Ordering Code	SİPARİŞ KODU Ordering Code Inter Coolant		D	Z	H	d			
TK 9936	x	✓	50	7	40	22	BOMT 1304	M3,5X8X4.80	T15
TK 9939	x	✓	63	8	40	22	BOMT 1304	M3,5X8X4.80	T15
TK 9940	x	✓	80	10	50	27	BOMT 1304	M3,5X8X4.80	T15

**90° AOMT 1605 INGRSL**

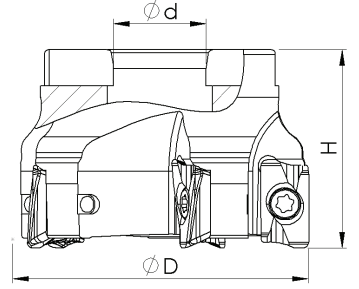

Kesici Uç Uyumluluğu Insert Suitability		Stok Stock	Takım Ölçüleri / Dimension (mm)				Uç Insert	Vida Screw	Anahtar Torx Key
90° AOMT 1605 INGRSL			D	Z	H	d			
SİPARİŞ KODU Ordering Code	SİPARİŞ KODU Ordering Code Inter Coolant								
TK 9832	X	✓	50	4	40	22	AOMT 1605	M4X11	T15
TK 9833	X	✓	63	5	40	22	AOMT 1605	M4X11	T15
TK 9834	X	✓	80	6	50	27	AOMT 1605	M4X11	T15
TK 9835	X	✓	100	8	50	32	AOMT 1605	M4X11	T15

**90° XDKT 1505 CRTZT**

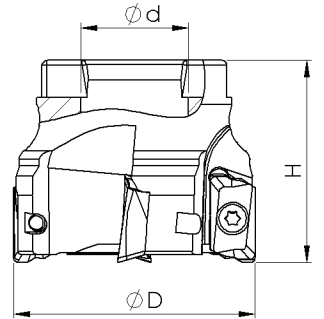

Kesici Uç Uyumluluğu Insert Suitability		Stok Stock	Takım Ölçüleri / Dimension (mm)				Uç Insert	Vida Screw	Anahtar Torx Key
90° XDKT 1505 CRTZT			D	Z	H	d			
SİPARİŞ KODU Ordering Code	SİPARİŞ KODU Ordering Code Inter Coolant								
TK 10476	X	✓	50	4	40	22	XDKT 1505	M4X11	T15
TK 10477	X	✓	63	5	40	22	XDKT 1505	M4X11	T15

## 88° SNMX 1206 KRLY

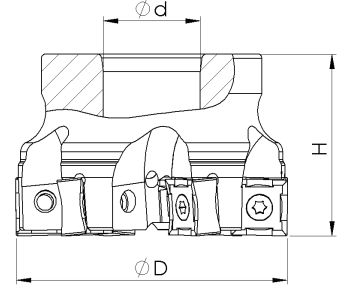

Kesici Uç Uyumluluğu Insert Suitability		Stok Stock	Takım Ölçüleri / Dimension (mm)				Uç Insert	Vida Screw	Anahtar Torx Key
88° SNMX 1206 KRLY			D	Z	H	d			
SİPARİŞ KODU Ordering Code	SİPARİŞ KODU Ordering Code Inter Cooland								
X	TK 10351	✓	50	5	40	22	SNMX 1206	M4,5X11	T20
X	TK 10353	✓	63	6	40	22	SNMX 1206	M4,5X11	T20
X	TK 10355	✓	80	8	50	27	SNMX 1206	M4,5X11	T20
X	TK 10357	✓	100	10	50	32	SNMX 1206	M4,5X11	T20
TK 10359	X	✓	125	11	62	40	SNMX 1206	M4,5X11	T20
TK 10315	X	✓	160	12	62	40	SNMX 1206	M4,5X11	T20
TK 12581	X	✓	160	14	62	40	SNMX 1206	M4,5X11	T20
TK 12624	X	✓	200	14	62	60	SNMX 1206	M4,5X11	T20

## 88° SNCU 1205 ZCC

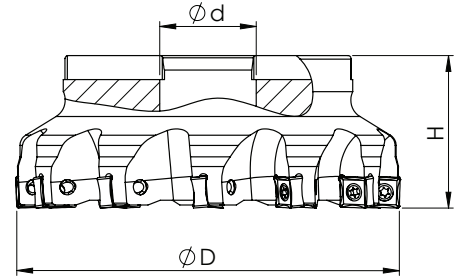

Kesici Uç Uyumluluğu Insert Suitability		Stok Stock	Takım Ölçüleri / Dimension (mm)				Uç Insert	Vida Screw	Anahtar Torx Key
88° SNCU 1205 ZCC			D	Z	H	d			
SİPARİŞ KODU Ordering Code	SİPARİŞ KODU Ordering Code Inter Cooland								
TK 12832	X	✓	160	12	62	40	SNCU 1205	M5X12	T20

### 75° APKT 1003 - 1604 ISO

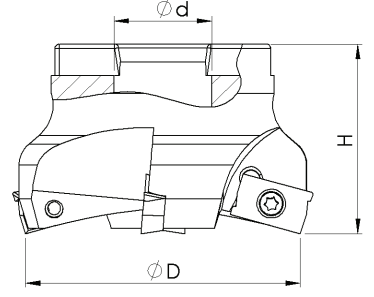

Kesici Uç Uyumluluğu Insert Suitability		Stok Stock	Takım Ölçüleri / Dimension (mm)				Uç İnsert	Vida Screw	Anahtar Torx Key
75° APKT 1003 - 1604 ISO			D	Z	H	d			
SİPARİŞ KODU Ordering Code	SİPARİŞ KODU Ordering Code Inter Coolant								
X	TK 9855	✓	63	6	40	22	APKT 1003	M2,5X7	T08
X	TK 9955	✓	63	4	40	22	APKT 1604	M3,5X11	T15
X	TK 9956	✓	80	5	40	27	APKT 1604	M3,5X11	T15
X	TK 9957	✓	100	6	40	32	APKT 1604	M3,5X11	T15
TK 9958	X	✓	125	7	52	40	APKT 1604	M3,5X11	T15
TK 12522	X	✓	160	8	52	40	APKT 1604	M3,5X11	T15

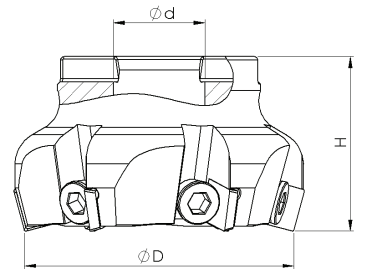
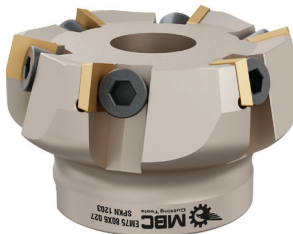

### 75° SPKN 1203 - 1504 ISO



Kesici Uç Uyumluluğu Insert Suitability		Stok Stock	Takım Ölçüleri / Dimension (mm)				Uç İnsert	Vida Screw	Anahtar Torx Key
75° SPKN 1203 - 1504 ISO			D	Z	H	d			
SİPARİŞ KODU Ordering Code	SİPARİŞ KODU Ordering Code Inter Coolant								
TK 10381	X	✓	63	5	40	22	SPKN 1203	M8X1 "L"	A6
TK 10382	X	✓	80	6	50	27	SPKN 1203	M8X1 "L"	A6
TK 10383	X	✓	100	8	50	32	SPKN 1203	M8X1 "L"	A6
TK 10384	X	✓	125	10	62	40	SPKN 1203	M8X1 "L"	A6
TK 10385	X	✓	160	12	62	40	SPKN 1203	M8X1 "L"	A6
TK 10386	X	✓	200	12	62	60	SPKN 1203	M8X1 "L"	A6

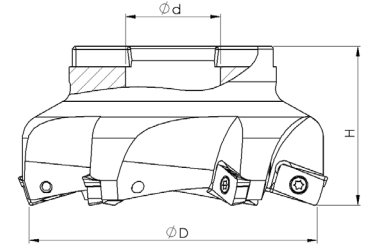

## 75° R390 1806 SNDVK

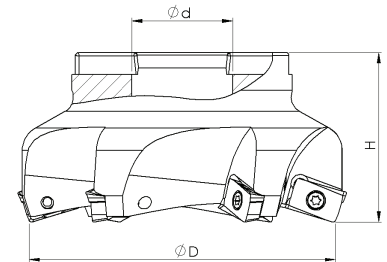

Kesici Uç Uyumluluğu Insert Suitability		Stok Stock	Takım Ölçüleri / Dimension (mm)				Uç Insert	Vida Screw	Anahtar Torx Key
75° R390 1806 SNDVK			D	Z	H	d			
SİPARİŞ KODU Ordering Code	SİPARİŞ KODU Ordering Code Inter Coolant								
TK 12851	x	✓	80	4	52	27	R390 1806	M4X11	T15
TK 11896	x	✓	100	5	52	32	R390 1806	M4X11	T15
TK 11897	x	✓	125	6	62	40	R390 1806	M4X11	T15

## 75° R390 1704 SNDVK



Kesici Uç Uyumluluğu Insert Suitability		Stok Stock	Takım Ölçüleri / Dimension (mm)				Uç Insert	Vida Screw	Anahtar Torx Key
75° R390 1704 SNDVK			D	Z	H	d			
SİPARİŞ KODU Ordering Code	SİPARİŞ KODU Ordering Code Inter Coolant								
TK 6823	x	✓	63	4	42	22	R390 1704	M3,5X11	T15
TK 6824	x	✓	80	5	52	27	R390 1704	M3,5X11	T15
TK 6825	x	✓	100	6	52	32	R390 1704	M3,5X11	T15

**45° OFKT 05T3 ZCC**

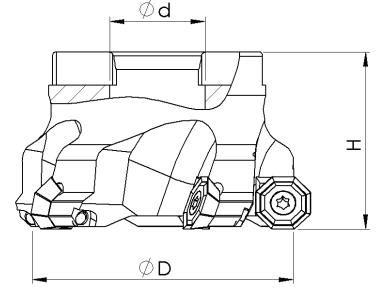

Kesici Uç Uyumluluğu Insert Suitability		Stok Stock	Takım Ölçüleri / Dimension (mm)				Uç Insert	Vida Screw	Anahtar Torx Key
SİPARİŞ KODU Ordering Code	SİPARİŞ KODU Ordering Code Inter Coolant		D	Z	H	d			
45° OFKT 05T3 ZCC									
X	TK 10103	✓	50	4	40	22	OFKT 05T3	M4X11	T15
X	TK 10104	✓	63	5	40	22	OFKT 05T3	M4X11	T15
X	TK 10105	✓	80	6	50	27	OFKT 05T3	M4X11	T15
X	TK 10106	✓	100	7	50	32	OFKT 05T3	M4X11	T15

**45° ONHU 08T6 ZCC**

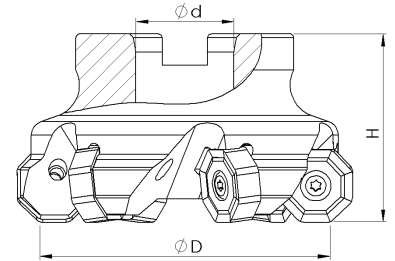

Kesici Uç Uyumluluğu Insert Suitability		Stok Stock	Takım Ölçüleri / Dimension (mm)				Uç Insert	Vida Screw	Anahtar Torx Key
SİPARİŞ KODU Ordering Code	SİPARİŞ KODU Ordering Code Inter Coolant		D	Z	H	d			
45° ONHU 08T6 ZCC									
X	TK 11890	✓	50	4	50	22	ON.. 08T6	M4,5X15	T20
X	TK 10115	✓	80	6	50	27	ON.. 08T6	M4,5X15	T20
X	TK 10116	✓	100	7	50	32	ON.. 08T6	M4,5X15	T20
TK 10117	X	✓	125	8	62	40	ON.. 08T6	M4,5X15	T20
TK 12424	X	✓	160	10	62	40	ON.. 08T6	M4,5X15	T20

## 45° ONHU 0604 ZCC

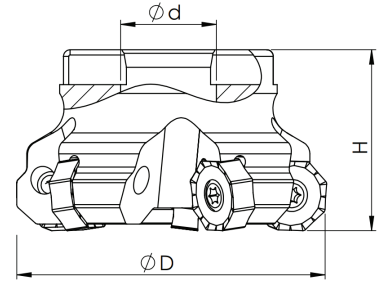

Kesici Uç Uyumluluğu Insert Suitability		Stok Stock	Takım Ölçüleri / Dimension (mm)				Uç Insert	Vida Screw	Anahtar Torx Key
45° ONHU 0604 ZCC			D	Z	H	d			
SİPARİŞ KODU Ordering Code	SİPARİŞ KODU Ordering Code Inter Cooland								
TK 12334	X	✓	63	5	40	22	ONHU 0604	M5X12	T20
TK 12335	X	✓	80	7	50	27	ONHU 0604	M5X12	T20
TK 12336	X	✓	100	8	52	32	ONHU 0604	M5X12	T20
TK 12337	X	✓	125	9	62	40	ONHU 0604	M5X12	T20

## 45° ONHU 09T5 ZCC

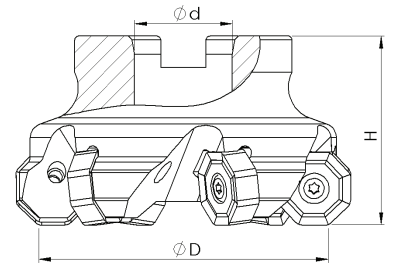
**NEW**

Kesici Uç Uyumluluğu Insert Suitability		Stok Stock	Takım Ölçüleri / Dimension (mm)				Uç Insert	Vida Screw	Anahtar Torx Key
45° ONHU 09T5 ZCC			D	Z	H	d			
SİPARİŞ KODU Ordering Code	SİPARİŞ KODU Ordering Code Inter Cooland								
X	TK 15391	✓	50	3	40	22	ONHU 09T5	M6X16	T25
X	TK 15392	✓	63	4	40	22	ONHU 09T5	M6X16	T25
X	TK 15393	✓	80	5	50	27	ONHU 09T5	M6X16	T25
X	TK 15394	✓	100	7	52	32	ONHU 09T5	M6X16	T25
TK 15395	X	✓	125	8	62	40	ONHU 09T5	M6X16	T25
TK 15396	X	✓	160	10	62	40	ONHU 09T5	M6X16	T25

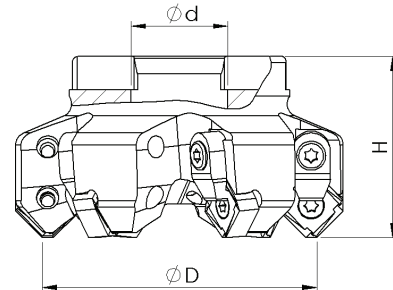
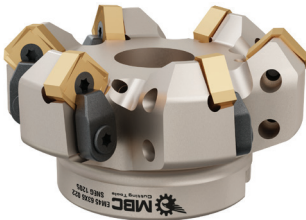

## 45° SNEG 1205 ZCC



Kesici Uç Uyumluluğu Insert Suitability		Stok Stock	Takım Ölçüleri / Dimension (mm)				Uç Insert	Vida Screw	Anahtar Torx Key
45° SNEG 1205 ZCC			D	Z	H	d			
SİPARİŞ KODU Ordering Code	SİPARİŞ KODU Ordering Code Inter Cooland								
X	TK 11891	✓	50	5	40	22	SNEG 1205	M4X11	T15
X	TK 10324	✓	63	6	40	22	SNEG 1205	M4X11	T15
X	TK 10325	✓	80	7	50	27	SNEG 1205	M4X11	T15
X	TK 11892	✓	100	8	62	32	SNEG 1205	M4X11	T15
TK 10326	X	✓	125	10	62	40	SNEG 1205	M4X11	T15

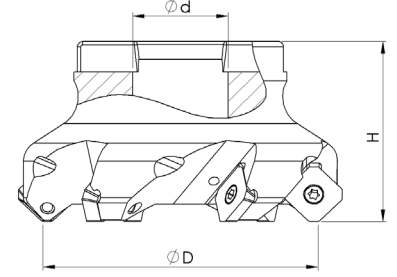



### 45° SE.. 12T3, SEET15.. ZCC - SNDVK

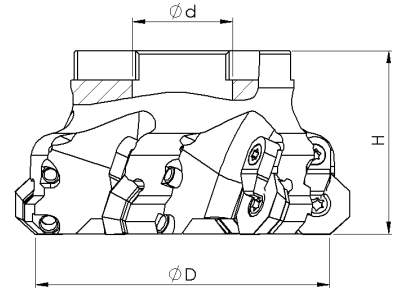

Kesici Uç Uyumluluğu Insert Suitability		Stok Stock	Takım Ölçüleri / Dimension (mm)				Uç Insert	Vida Screw	Anahtar Torx Key
45° SE.. 12T3, SEET15.. ZCC - SNDVK			D	Z	H	d			
SİPARİŞ KODU Ordering Code	SİPARİŞ KODU Ordering Code Inter Coolant								
X	TK 10279	✓	50	4	40	22	SE.. 12T3	M3,5X11	T15
X	TK 10280	✓	63	5	40	22	SE.. 12T3	M3,5X11	T15
X	TK 10281	✓	80	6	50	27	SE.. 12T3	M3,5X11	T15
X	TK 10282	✓	100	7	50	32	SE.. 12T3	M3,5X11	T15
TK 10283	X	✓	125	8	62	40	SE.. 12T3	M3,5X11	T15
TK 10285	X	✓	160	10	62	40	SE.. 12T3	M3,5X11	T15



### 45° OFMT 0706 ISO



Kesici Uç Uyumluluğu Insert Suitability		Stok Stock	Takım Ölçüleri / Dimension (mm)				Uç Insert	Vida Screw	Pabuç Clamp	Vida Screw	Anahtar Torx Key
45° OFMT 0706 ISO			D	Z	H	d					
SİPARİŞ KODU Ordering Code	SİPARİŞ KODU Ordering Code Inter Coolant										
X	TK 10107	✓	63	5	43	22	OFMT 0706	M5X12	CK15	M4X11	T20
X	TK 10109	✓	80	6	50	27	OFMT 0706	M5X12	CK15	M4X11	T20
X	TK 10110	✓	100	7	50	32	OFMT 0706	M5X12	CK15	M4X11	T20
TK 10111	X	✓	125	8	62	40	OFMT 0706	M5X12	CK15	M4X11	T20

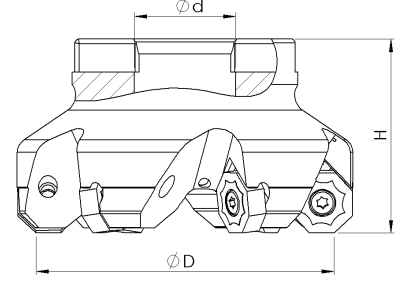

## 45° ONGX 0606 ISO

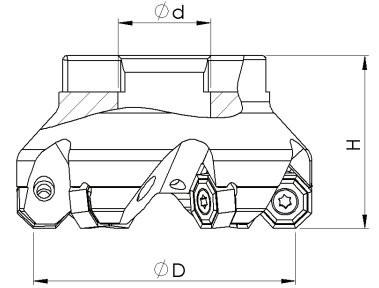

Kesici Uç Uyumluluğu Insert Suitability		Stok Stock	Takım Ölçüleri / Dimension (mm)				Uç Insert	Vida Screw	Anahtar Torx Key
45° ONGX 0606 ISO			D	Z	H	d			
SİPARİŞ KODU Ordering Code	SİPARİŞ KODU Ordering Code Inter Cooland								
X	TK 11737	✓	63	5	45	22	ONGX 0606	M4,5X15	T20
X	TK 11738	✓	80	6	50	27	ONGX 0606	M4,5X15	T20
X	TK 11739	✓	100	8	50	32	ONGX 0606	M4,5X15	T20
TK 11741	X	✓	160	10	62	40	ONGX 0606	M4,5X15	T20

## 45° ONMU 0504 ISO



Kesici Uç Uyumluluğu Insert Suitability		Stok Stock	Takım Ölçüleri / Dimension (mm)				Uç Insert	Vida Screw	Anahtar Torx Key
45° ONMU 0504 ISO			D	Z	H	d			
SİPARİŞ KODU Ordering Code	SİPARİŞ KODU Ordering Code Inter Cooland								
X	TK 11742	✓	50	5	40	22	ONMU 0504	M4X11	T15
X	TK 11743	✓	63	6	40	22	ONMU 0504	M4X11	T15
X	TK 11744	✓	80	7	50	27	ONMU 0504	M4X11	T15
X	TK 11745	✓	100	8	52	32	ONMU 0504	M4X11	T15
TK 11746	X	✓	125	9	62	40	ONMU 0504	M4X11	T15

**45° PNCU 0805 ISO**

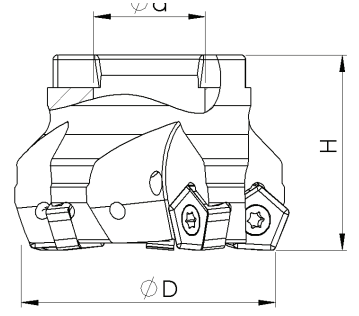

Kesici Uç Uyumluluğu Insert Suitability		Stok Stock	Takım Ölçüleri / Dimension (mm)				Uç Insert	Vida Screw	Anahtar Torx Key
45° PNCU 0805 ISO			D	Z	H	d			
SİPARİŞ KODU Ordering Code	SİPARİŞ KODU Ordering Code Inter Coolant								
X	TK 10141	✓	50	5	40	22	PNCU 0805	M4X11	T15
X	TK 12808	✓	63	5	50	22	PNCU 0805	M4X11	T15
X	TK 10142	✓	80	6	50	27	PNCU 0805	M4X11	T15

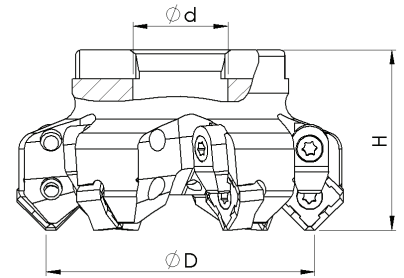

**45° SNMX 1206 KRLY**



Kesici Uç Uyumluluğu Insert Suitability		Stok Stock	Takım Ölçüleri / Dimension (mm)				Uç Insert	Vida Screw	Pabuç Clamp	Vida Screw	Anahtar Torx Key
45° SNMX 1206 KRLY			D	Z	H	d					
SİPARİŞ KODU Ordering Code	SİPARİŞ KODU Ordering Code Inter Coolant										
X	TK 10301	✓	50	5	40	22	SN.. 1206	M4X11	CK15	M4X11	T15
X	TK 10303	✓	63	6	40	22	SN.. 1206	M4X11	CK15	M4X11	T15
X	TK 10305	✓	80	8	50	27	SN.. 1206	M4X11	CK15	M4X11	T15
X	TK 10308	✓	100	10	50	32	SN.. 1206	M4X11	CK15	M4X11	T15
TK 10310	X	✓	125	11	62	40	SN.. 1206	M4X11	CK15	M4X11	T15
TK 10312	X	✓	160	12	62	40	SN.. 1206	M4X11	CK15	M4X11	T15

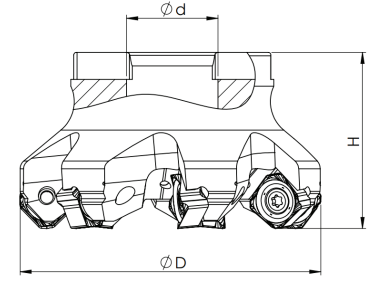

## 45° SNMX 1407 SCO



Kesici Uç Uyumluluğu Insert Suitability		Stok Stock	Takım Ölçüleri / Dimension (mm)				Uç Insert	Vida Screw	Anahtar Allen Key
SİPARİŞ KODU Ordering Code	SİPARİŞ KODU Ordering Code Inter Cooland		D	Z	H	d			
45° SNMX 1407 SCO									
TK 11605	X	✓	100	7	62	32	SNMX 1407	M4,5X12	T20
TK 11606	X	✓	125	8	62	40	SNMX 1407	M4,5X12	T20

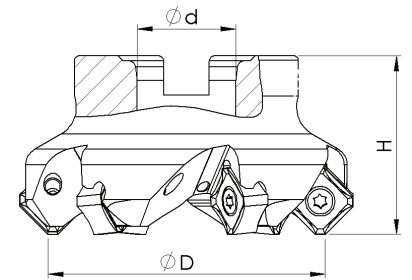

## 45° SNHG 1205 VNDRT



Kesici Uç Uyumluluğu Insert Suitability		Stok Stock	Takım Ölçüleri / Dimension (mm)				Uç Insert	Vida Screw	Anahtar Torx Key
SİPARİŞ KODU Ordering Code	SİPARİŞ KODU Ordering Code Inter Cooland		D	Z	H	d			
45° SNHG 1205 VNDRT									
X	TK 10327	✓	50	6	40	22	SNHG 1205	M4X11	T15
X	TK 10328	✓	63	6	40	22	SNHG 1205	M4X11	T15
X	TK 10329	✓	80	7	50	27	SNHG 1205	M4X11	T15
X	TK 10330	✓	100	8	50	32	SNHG 1205	M4X11	T15

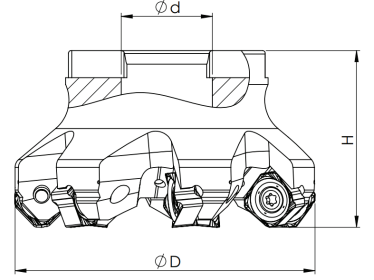

**45° SNGU 1408 MTSBSH**



Kesici Uç Uyumluluğu Insert Suitability		Stok Stock	Takım Ölçüleri / Dimension (mm)				Uç Insert	Vida Screw	Anahtar Torx Key
45° SNGU 1408 MTSBSH			D	Z	H	d			
SİPARİŞ KODU Ordering Code	SİPARİŞ KODU Ordering Code Inter Coolant								
x	TK 12903	✓	63	5	40	22	SNGU 1408	M4,5X11	T20
x	TK 12904	✓	80	7	50	27	SNGU 1408	M4,5X11	T20
x	TK 12905	✓	100	8	50	32	SNGU 1408	M4,5X11	T20

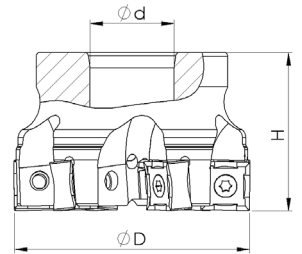

**88° SNMX 1306 TT**



Kesici Uç Uyumluluğu Insert Suitability		Stok Stock	Takım Ölçüleri / Dimension (mm)				Uç Insert	Vida Screw	Anahtar Torx Key
45° SNMX 1306 TT			D	Z	H	d			
SİPARİŞ KODU Ordering Code	SİPARİŞ KODU Ordering Code Inter Coolant								
x	TK 12939	✓	63	6	40	22	SNMX 1306	M4,5X11	T20
x	TK 12940	✓	80	8	50	27	SNMX 1306	M4,5X11	T20
x	TK 12941	✓	100	10	50	32	SNMX 1306	M4,5X11	T20

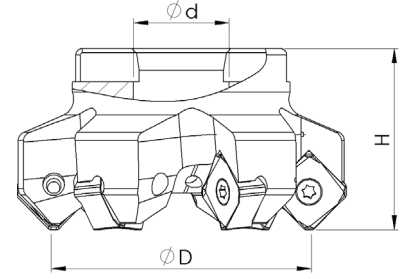

## 45° SNMU 13T6 SMTM



Kesici Uç Uyumluluğu Insert Suitability		Stok Stock	Takım Ölçüleri / Dimension (mm)				Uç Insert	Vida Screw	Anahtar Torx Key
45° SNMU 13T6 SMTM			D	Z	H	d			
X	TK 10347	✓	63	6	40	22	SNMU 13T6	M4X11	T15
X	TK 10348	✓	80	7	50	27	SNMU 13T6	M4X11	T15
X	TK 10349	✓	100	8	50	32	SNMU 13T6	M4X11	T15

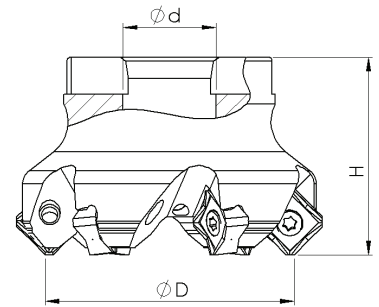

## 45° SN.. 1305 I



Kesici Uç Uyumluluğu Insert Suitability		Stok Stock	Takım Ölçüleri / Dimension (mm)				Uç Insert	Vida Screw	Anahtar Torx Key
45° SN.. 1305 I			D	Z	H	d			
X	TK 10316	✓	50	4	40	22	SN.. 1305	M4,5X12	T20
X	TK 10317	✓	63	6	40	22	SN.. 1305	M4,5X12	T20
X	TK 10318	✓	80	7	50	27	SN.. 1305	M4,5X12	T20
X	TK 10319	✓	100	8	50	32	SN.. 1305	M4,5X12	T20
TK 10320	X	✓	125	9	62	40	SN.. 1305	M4,5X12	T20

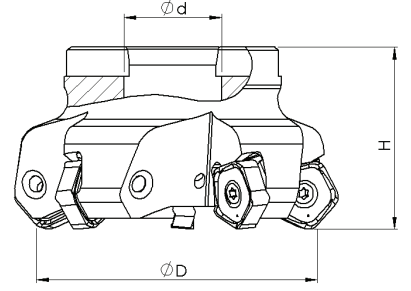

**45° PNMU 1205 KYCR**

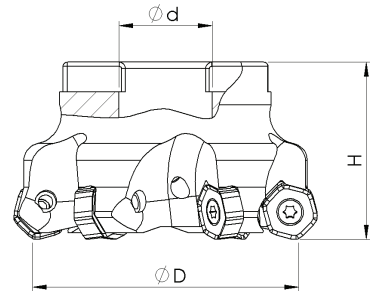
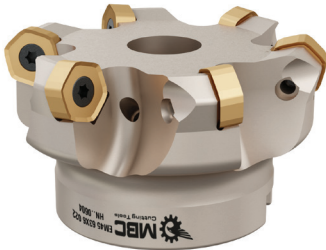

Kesici Uç Uyumluluğu Insert Suitability		Stok Stock	Takım Ölçüleri / Dimension (mm)				Uç Insert	Vida Screw	Anahtar Torx Key
45° PNMU 1205 KYCR			D	Z	H	d			
X	TK 10147	✓	50	4	40	22	PNMU 1205	M5X12	T20
X	TK 10148	✓	63	5	40	22	PNMU 1205	M5X12	T20
X	TK 10149	✓	80	5	45	27	PNMU 1205	M5X12	T20
X	TK 10150	✓	100	8	50	32	PNMU 1205	M5X12	T20
TK 10151	X	✓	125	10	50	40	PNMU 1205	M5X12	T20
TK 10152	X	✓	160	12	50	40	PNMU 1205	M5X12	T20
TK 10154	X	✓	250	14	62	60	PNMU 1205	M5X12	T20

**45° HN.. 0604 KNMTL**



Kesici Uç Uyumluluğu Insert Suitability		Stok Stock	Takım Ölçüleri / Dimension (mm)				Uç Insert	Vida Screw	Anahtar Torx Key
45° HN.. 0604 KNMTL			D	Z	H	d			
X	TK 9966	✓	63	6	40	22	HN.. 0604	M4X11	T15
X	TK 9967	✓	80	6	50	27	HN.. 0604	M4X11	T15
X	TK 9968	✓	100	8	50	32	HN.. 0604	M4X11	T15

## 45° HNGJ 0905 WDA - KNMTL

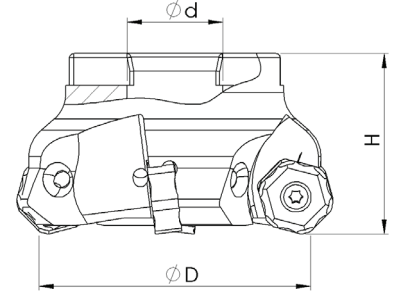

Kesici Uç Uyumluluğu Insert Suitability		Stok Stock	Takım Ölçüleri / Dimension (mm)				Uç İnsert	Vida Screw	Anahtar Torx Key
SİPARİŞ KODU Ordering Code	SİPARİŞ KODU Ordering Code Inter Coolant		D	Z	H	d			
X	TK 9970	✓	50	4	40	22	HN.. 0905	M4X14	T15
X	TK 9972	✓	63	4	40	22	HN.. 0905	M4X14	T15
X	TK 9976	✓	80	6	50	27	HN.. 0905	M4X14	T15
X	TK 9978	✓	100	8	52	32	HN.. 0905	M4X14	T15
TK 9980	X	✓	125	10	62	40	HN.. 0905	M4X14	T15
TK 9982	X	✓	160	12	62	40	HN.. 0905	M4X14	T15
TK 12697	X	✓	250	14	62	60	HN.. 0905	M4X14	T15

## 45° HNPJ 0704 WDA

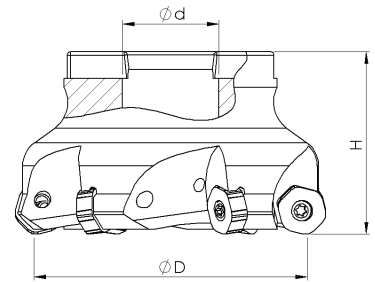

Kesici Uç Uyumluluğu Insert Suitability		Stok Stock	Takım Ölçüleri / Dimension (mm)				Uç İnsert	Vida Screw	Anahtar Torx Key
SİPARİŞ KODU Ordering Code	SİPARİŞ KODU Ordering Code Inter Coolant		D	Z	H	d			
X	TK 9997	✓	50	4	40	22	HNPJ 0704	M4X11	T15
X	TK 13111	✓	50	5	40	22	HNPJ 0704	M4X11	T15
X	TK 9998	✓	63	5	40	22	HNPJ 0704	M4X11	T15
X	TK 10000	✓	80	6	50	27	HNPJ 0704	M4X11	T15
X	TK 10002	✓	100	7	50	32	HNPJ 0704	M4X11	T15
TK 10003	X	✓	125	8	63	40	HNPJ 0704	M4X11	T15
TK 10004	X	✓	160	10	63	40	HNPJ 0704	M4X11	T15

**45° HN.. 0906 PRMT**

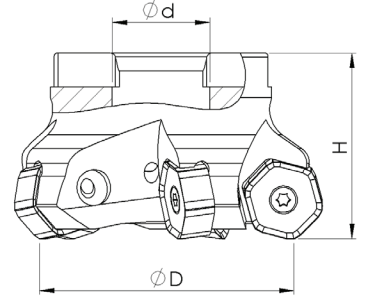

Kesici Uç Uyumluluğu Insert Suitability		Stok Stock	Takım Ölçüleri / Dimension (mm)				Uç Insert	Vida Screw	Anahtar Torx Key
45° HN.. 0906 PRMT			D	Z	H	d			
SİPARİŞ KODU Ordering Code	SİPARİŞ KODU Ordering Code Inter Coolant								
X	TK 9971	✓	50	4	40	22	HN.. 0906	M4X14	T15
X	TK 11225	✓	63	5	40	22	HN.. 0906	M4X14	T15
X	TK 9975	✓	80	6	50	27	HN.. 0906	M4X14	T15
X	TK 9977	✓	100	8	50	32	HN.. 0906	M4X14	T15
TK 9979	X	✓	125	10	62	40	HN.. 0906	M4X14	T15
TK 9981	X	✓	160	12	62	40	HN.. 0906	M4X14	T15
TK 9983	X	✓	200	12	62	60	HN.. 0906	M4X14	T15
TK 9985	X	✓	250	14	62	60	HN.. 0906	M4X14	T15
TK 9989	X	✓	300	16	62	60	HN.. 0906	M4X14	T15

**44° ONMU 0505 I**

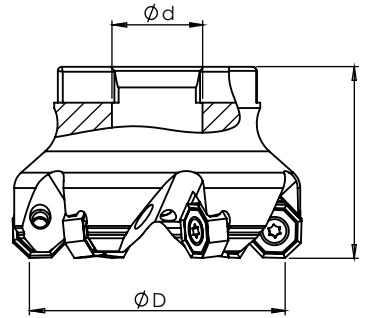

Kesici Uç Uyumluluğu Insert Suitability		Stok Stock	Takım Ölçüleri / Dimension (mm)				Uç Insert	Vida Screw	Anahtar Torx Key
44° ONMU 0505 I			D	Z	H	d			
SİPARİŞ KODU Ordering Code	SİPARİŞ KODU Ordering Code Inter Coolant								
X	TK 10122	✓	40	3	40	16	ONMU 0505	M4,5X12	T20
X	TK 10123	✓	50	4	40	22	ONMU 0505	M4,5X12	T20
X	TK 10124	✓	63	6	45	22	ONMU 0505	M4,5X12	T20
X	TK 10125	✓	80	7	52	27	ONMU 0505	M4,5X12	T20
X	TK 10126	✓	100	8	52	32	ONMU 0505	M4,5X12	T20
TK 10127	X	✓	125	9	62	40	ONMU 0505	M4,5X12	T20
TK 12066	X	✓	160	10	62	40	ONMU 0505	M4,5X12	T20

## 44° ONMX 1205 VNDRT

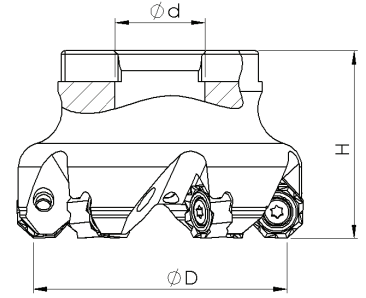

Kesici Uç Uyumluluğu Insert Suitability		Stok Stock	Takım Ölçüleri / Dimension (mm)				Uç Insert	Vida Screw	Anahtar Torx Key
44° ONMX 1205 VNDRT			D	Z	H	d			
SİPARİŞ KODU Ordering Code	SİPARİŞ KODU Ordering Code Inter Coolant								
X	TK 10129	✓	80	6	45	27	ONMX 1205	M4,5X12	T20
X	TK 10130	✓	100	8	45	32	ONMX 1205	M4,5X12	T20
TK 10131	X	✓	125	10	50	40	ONMX 1205	M4,5X12	T20

## 40° NNMU 2007 MTSBSH

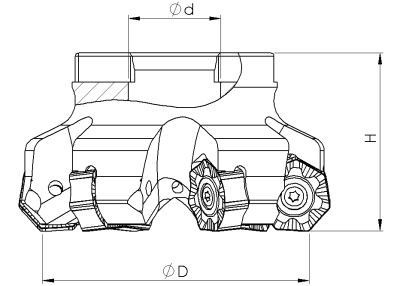

Kesici Uç Uyumluluğu Insert Suitability		Stok Stock	Takım Ölçüleri / Dimension (mm)				Uç Insert	Vida Screw	Anahtar Torx Key
40° NNMU 2007 MTSBSH			D	Z	H	d			
SİPARİŞ KODU Ordering Code	SİPARİŞ KODU Ordering Code Inter Coolant								
X	TK 10088	✓	63	5	45	22	NNMU 2007	M5X16	T20
X	TK 10089	✓	80	6	45	27	NNMU 2007	M5X16	T20
X	TK 10090	✓	100	7	50	32	NNMU 2007	M5X16	T20
TK 10091	X	✓	125	8	50	40	NNMU 2007	M5X16	T20
TK 10092	X	✓	160	10	55	40	NNMU 2007	M5X16	T20
TK 10093	X	✓	200	12	55	60	NNMU 2007	M5X16	T20

## 67° PNEG 1105 ZCC

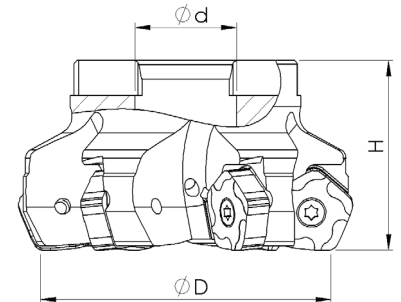

Kesici Uç Uyumluluğu Insert Suitability		Stok Stock	Takım Ölçüleri / Dimension (mm)				Uç Insert	Vida Screw	Anahtar Torx Key
67° PNEG 1105 ZCC			D	Z	H	d			
SİPARİŞ KODU - R Ordering Code - R	SİPARİŞ KODU Ordering Code Inter Coolant								
X	TK 11750	✓	50	5	40	22	PNEG 1105	M4X11	T15
X	TK 11751	✓	63	6	40	22	PNEG 1105	M4X11	T15
X	TK 11752	✓	80	8	50	27	PNEG 1105	M4X11	T15
X	TK 11753	✓	100	10	50	32	PNEG 1105	M4X11	T15
TK 11754	X	✓	125	12	62	40	PNEG 1105	M4X11	T15
TK 11755	X	✓	160	14	62	40	PNEG 1105	M4X11	T15

## SDMT 09T3 ZCC

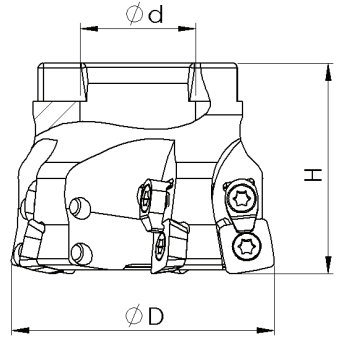
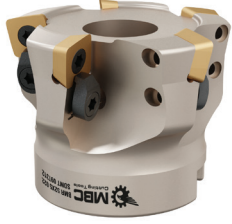

Kesici Uç Uyumluluğu Insert Suitability		Stok Stock	Takım Ölçüleri / Dimension (mm)				Uç Insert	Vida Screw	Pabuç Clamp	Vida Screw	Anahtar Torx Key
SDMT 09T3 ZCC			D	Z	H	d					
SİPARİŞ KODU Ordering Code	SİPARİŞ KODU Ordering Code Inter Cooland										
X	TK 10240	✓	40	4	40	16	SDMT 09T3	M3,5X11	CK14	M3,5X11	T15
X	TK 10242	✓	50	4	40	22	SDMT 09T3	M3,5X11	CK14	M3,5X11	T15
X	TK 10246	✓	50	5	40	22	SDMT 09T3	M3,5X11	CK14	M3,5X11	T15
X	TK 10248	✓	52	5	40	22	SDMT 09T3	M3,5X11	CK14	M3,5X11	T15
X	TK 10250	✓	52	6	40	22	SDMT 09T3	M3,5X11	CK14	M3,5X11	T15
X	TK 10251	✓	60	6	40	22	SDMT 09T3	M3,5X11	CK14	M3,5X11	T15
X	TK 10252	✓	63	6	40	22	SDMT 09T3	M3,5X11	CK14	M3,5X11	T15
X	TK 12823	✓	80	7	50	27	SDMT 09T3	M3,5X11	CK14	M3,5X11	T15
X	TK 12824	✓	100	8	50	32	SDMT 09T3	M3,5X11	CK14	M3,5X11	T15

## SDMT 1204 ZCC

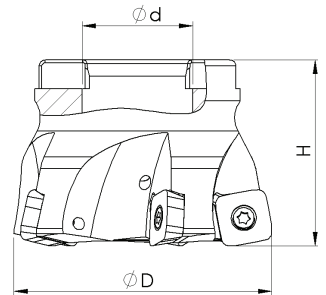

Kesici Uç Uyumluluğu Insert Suitability		Stok Stock	Takım Ölçüleri / Dimension (mm)				Uç Insert	Vida Screw	Anahtar Torx Key
SDMT 1204 ZCC			D	Z	H	d			
SİPARİŞ KODU Ordering Code	SİPARİŞ KODU Ordering Code Inter Cooland								
X	TK 10263	✓	50	4	40	22	SDMT 1204	M4X11	T15
X	TK 10258	✓	52	4	40	22	SDMT 1204	M4X11	T15
X	TK 10265	✓	63	5	40	22	SDMT 1204	M4X11	T15
X	TK 10260	✓	66	5	40	22	SDMT 1204	M4X11	T15
X	TK 10261	✓	66	5	40	27	SDMT 1204	M4X11	T15
X	TK 10262	✓	80	6	50	27	SDMT 1204	M4X11	T15
X	TK 12527	✓	100	8	50	32	SDMT 1204	M4X11	T15

## ZDCW 09T3 - ZDEW 1204 PRMT

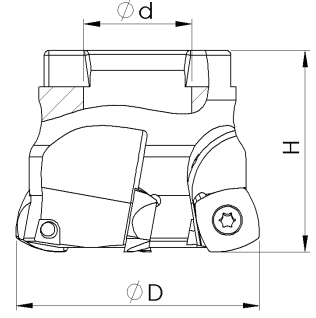

Kesici Uç Uyumluluğu Insert Suitability		Stok Stock	Takım Ölçüleri / Dimension (mm)				Uç Insert	Vida Screw	Pabuç Clamp	Vida Screw	Anahtar Torx Key
SIPARIŞ KODU Ordering Code	SIPARIŞ KODU Ordering Code Inter Coolant		D	Z	H	d					
X	TK 10501	✓	40	4	40	16	ZDCW 09T3	M3X8	-	-	T10
X	TK 10502	✓	50	4	40	22	ZDEW 1204	M4X11	CK14	M4X11	T15
X	TK 10503	✓	63	5	40	22	ZDEW 1204	M4X11	CK14	M4X11	T15

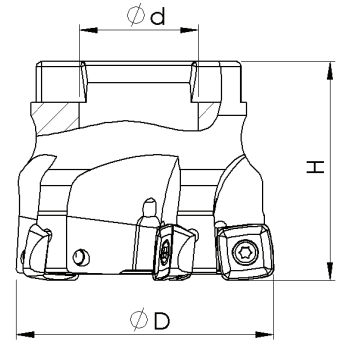

## SDMT 1004 BHLR



Kesici Uç Uyumluluğu Insert Suitability		Stok Stock	Takım Ölçüleri / Dimension (mm)				Uç Insert	Vida Screw	Anahtar Torx Key
SIPARIŞ KODU Ordering Code	SIPARIŞ KODU Ordering Code Inter Coolant		D	Z	H	d			
X	TK 10253	✓	50	5	40	22	SDMT 1004	M3X10	T10
X	TK 10254	✓	40	4	40	16	SDMT 1004	M3X10	T10

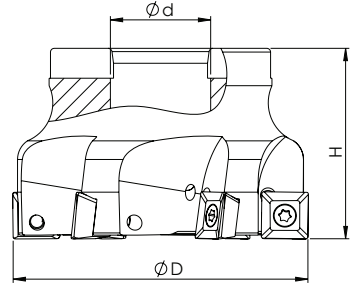

## SDMT 1206 ING

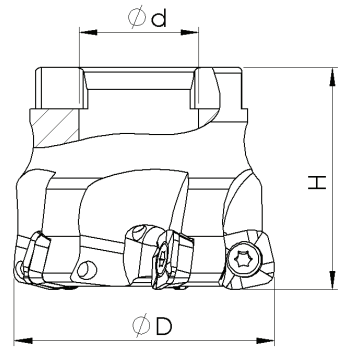

Kesici Uç Uyumluluğu Insert Suitability		Stok Stock	Takım Ölçüleri / Dimension (mm)				Uç Insert	Vida Screw	Anahtar Torx Key
SDMT 1206 ING			D	Z	H	d			
SIPARIŞ KODU Ordering Code	SIPARIŞ KODU Ordering Code Inter Coolant								
X	TK 12830	✓	63	5	50	22	SDMT 1206	M4X11	T15
X	TK 12831	✓	80	6	50	27	SDMT 1206	M4X11	T15

## SOMT 1004 - 1405 KYCR



Kesici Uç Uyumluluğu Insert Suitability		Stok Stock	Takım Ölçüleri / Dimension (mm)				Uç Insert	Vida Screw	Anahtar Torx Key
SOMT 1004 - 1405 KYCR			D	Z	H	d			
SIPARIŞ KODU Ordering Code	SIPARIŞ KODU Ordering Code Inter Coolant								
X	TK 10368	✓	50	5	40	22	SOMT 1004	M4X11	T15
X	TK 10369	✓	52	5	50	22	SOMT 1004	M4X11	T15
X	TK 14219	✓	63	6	40	22	SOMT 1004	M4X11	T15
X	TK 11760	✓	52	4	50	22	SOMT 1405	M5X12	T20
X	TK 10378	✓	63	5	40	22	SOMT 1405	M5X12	T20
X	TK 13073	✓	66	5	40	27	SOMT 1405	M5X12	T20
X	TK 10379	✓	80	6	60	27	SOMT 1405	M5X12	T20

## LOGU 0303 KYCR

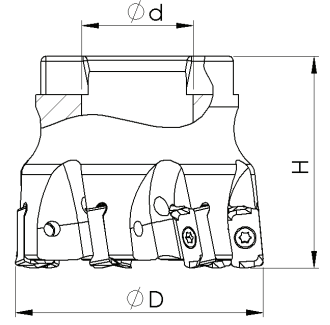

Kesici Uç Uyumluluğu Insert Suitability		Stok Stock	Takım Ölçüleri / Dimension (mm)				Uç Insert	Vida Screw	Anahtar Torx Key
SIPARIŞ KODU Ordering Code	SIPARIŞ KODU Ordering Code Inter Coolant		D	Z	H	d			
X	TK 10068	✓	40	6	40	16	LOGU 0303	M3X8	T08 - T10
X	TK 11416	✓	50	6	50	22	LOGU 0303	M3X8	T08 - T10
X	TK 10069	✓	50	7	50	22	LOGU 0303	M3X8	T08 - T10
X	TK 10071	✓	52	6	50	22	LOGU 0303	M3X8	T08 - T10

## WNMX 09T3 - 1305 KRLY

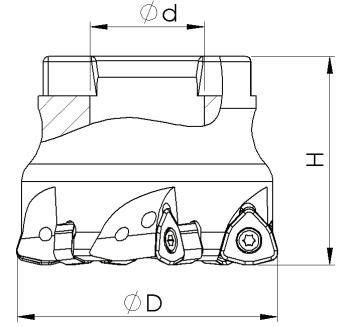

Kesici Uç Uyumluluğu Insert Suitability		Stok Stock	Takım Ölçüleri / Dimension (mm)				Uç Insert	Vida Screw	Anahtar Torx Key
SIPARIŞ KODU Ordering Code	SIPARIŞ KODU Ordering Code Inter Coolant		D	Z	H	d			
X	TK 10459	✓	40	4	40	16	WNMX 09T3	M3X10	T10
X	TK 10460	✓	50	4	40	22	WNMX 09T3	M3X10	T10
X	TK 10461	✓	52	4	40	22	WNMX 09T3	M3X10	T10
X	TK 10462	✓	52	5	40	22	WNMX 09T3	M3X10	T10
X	TK 10463	✓	52	6	40	22	WNMX 09T3	M3X10	T10
X	TK 10464	✓	63	5	50	22	WNMX 09T3	M3X10	T10
X	TK 10465	✓	66	6	50	22	WNMX 09T3	M3X10	T10
X	TK 10466	✓	66	6	50	27	WNMX 09T3	M3X10	T10
X	TK 12441	✓	80	7	50	27	WNMX 09T3	M3X10	T10
X	TK 12909	✓	52	4	40	22	WNMX 1305	M4X11	T15
X	TK 10468	✓	63	4	40	22	WNMX 1305	M4X11	T15
X	TK 10469	✓	80	5	50	27	WNMX 1305	M4X11	T15

**LNMT 0603 KRLY**

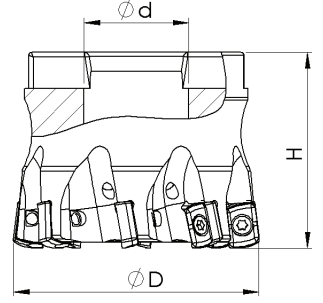

Kesici Uç Uyumluluğu Insert Suitability		Stok Stock	Takım Ölçüleri / Dimension (mm)				Uç Insert	Vida Screw	Anahtar Torx Key
LNMT 0603 KRLY			D	Z	H	d			
SİPARİŞ KODU Ordering Code	SİPARİŞ KODU Ordering Code Inter Coolant								
X	TK 10041	✓	40	6	40	16	LNMT 0603	M3X8	T10
X	TK 10042	✓	52	8	40	22	LNMT 0603	M3X8	T10
X	TK 11764	✓	63	9	50	22	LNMT 0603	M3X8	T10
X	TK 10043	✓	66	9	50	27	LNMT 0603	M3X8	T10

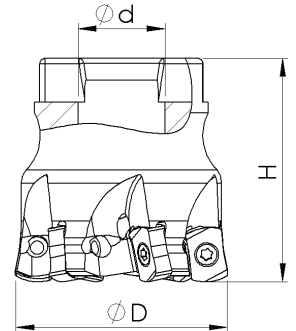

**LNMX 0603 KRLY**



Kesici Uç Uyumluluğu Insert Suitability		Stok Stock	Takım Ölçüleri / Dimension (mm)				Uç Insert	Vida Screw	Anahtar Torx Key
LNMX 0603 KRLY			D	Z	H	d			
SİPARİŞ KODU Ordering Code	SİPARİŞ KODU Ordering Code Inter Coolant								
X	TK 11765	✓	42	6	40	16	LNMX 0603	M2,5X7	T08
X	TK 12303	✓	50	7	40	22	LNMX 0603	M2,5X7	T08
X	TK 11403	✓	52	7	40	22	LNMX 0603	M2,5X7	T08
X	TK 11404	✓	52	8	40	22	LNMX 0603	M2,5X7	T08
X	TK 12306	✓	63	8	50	22	LNMX 0603	M2,5X7	T08
X	TK 12495	✓	80	10	50	27	LNMX 0603	M2,5X7	T08

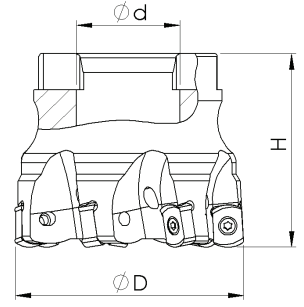

## BLMP 0603 TT



Kesici Uç Uyumluluğu Insert Suitability		Stok Stock	Takım Ölçüleri / Dimension (mm)				Uç Insert	Vida Screw	Anahtar Torx Key
BLMP 0603 TT			D	Z	H	d			
X	TK 9933	✓	40	6	40	16	BLMP 0603	M2,5X7	T08
X	TK 9934	✓	50	7	40	22	BLMP 0603	M2,5X7	T08
X	TK 9935	✓	63	8	40	22	BLMP 0603	M2,5X7	T08

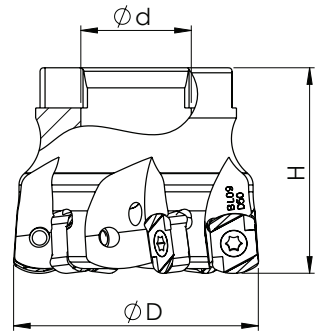

## BLMP 0904 TT



Kesici Uç Uyumluluğu Insert Suitability		Stok Stock	Takım Ölçüleri / Dimension (mm)				Uç Insert	Vida Screw	Anahtar Torx Key
BLMP 0904 TT			D	Z	H	d			
X	TK 16895	✓	40	5	40	16	BLMP 0904	M3,5X10	T15
X	TK 16896	✓	50	6	40	22	BLMP 0904	M3,5X10	T15
X	TK 16897	✓	52	6	40	22	BLMP 0904	M3,5X10	T15
X	TK 16898	✓	63	7	40	22	BLMP 0904	M3,5X10	T15

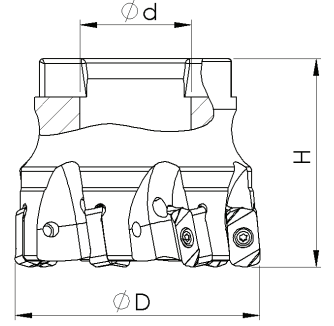

**LNMU 0303 TNGLY**



Kesici Uç Uyumluluğu Insert Suitability		Stok Stock	Takım Ölçüleri / Dimension (mm)				Uç Insert	Vida Screw	Anahtar Torx Key
LNMU 0603 TNGLY			D	Z	H	d			
SİPARİŞ KODU Ordering Code	SİPARİŞ KODU Ordering Code Inter Cooland								
X	TK 10046	✓	40	6	40	16	LNMU 0303	M2,5X7	T08
X	TK 10047	✓	50	7	40	22	LNMU 0303	M2,5X7	T08
X	TK 12432	✓	52	7	40	22	LNMU 0303	M2,5X7	T08
X	TK 10048	✓	63	8	40	22	LNMU 0303	M2,5X7	T08

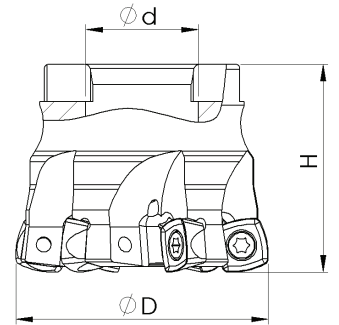

**XDPT 0904 WDA**



Kesici Uç Uyumluluğu Insert Suitability		Stok Stock	Takım Ölçüleri / Dimension (mm)				Uç Insert	Vida Screw	Anahtar Torx Key
XDPT 0904 WDA			D	Z	H	d			
SİPARİŞ KODU Ordering Code	SİPARİŞ KODU Ordering Code Inter Cooland								
X	TK 11766	✓	40	5	40	16	XDPT 0904	M3,5X10	T15
X	TK 11468	✓	50	5	40	22	XDPT 0904	M3,5X10	T15
X	TK 11767	✓	50	6	40	22	XDPT 0904	M3,5X10	T15
X	TK 11768	✓	52	6	40	22	XDPT 0904	M3,5X10	T15

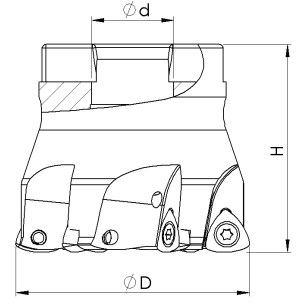
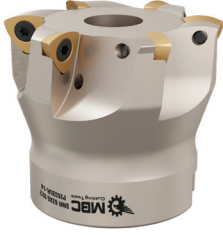

## P26335 WLTR

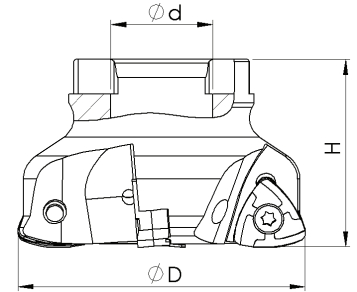

Kesici Uç Uyumluluğu Insert Suitability		Stok Stock	Takım Ölçüleri / Dimension (mm)				Uç Insert	Vida Screw	Anahtar Torx Key
P26335 WLTR			D	Z	H	d			
SİPARİŞ KODU Ordering Code	SİPARİŞ KODU Ordering Code Inter Cooland								
X	TK 10132	✓	50	5	40	22	P26335R-14	M4X11	T15
X	TK 10133	✓	52	5	55	22	P26335R-14	M4X11	T15
X	TK 10134	✓	63	6	55	22	P26335R-14	M4X11	T15
X	TK 10135	✓	52	3	40	22	P26335R-25	M4,5X15	T20

## UNEU 1307R INGRSL



Kesici Uç Uyumluluğu Insert Suitability		Stok Stock	Takım Ölçüleri / Dimension (mm)				Uç Insert	Vida Screw	Anahtar Torx Key
UNEU 1307R INGRSL			D	Z	H	d			
SİPARİŞ KODU Ordering Code	SİPARİŞ KODU Ordering Code Inter Cooland								
X	TK 11769	✓	52	3	40	22	UNEU 1307R	M4,5X12	T20
X	TK 11770	✓	63	4	40	22	UNEU 1307R	M4,5X12	T20

**RPMT 10T3 KYCR**

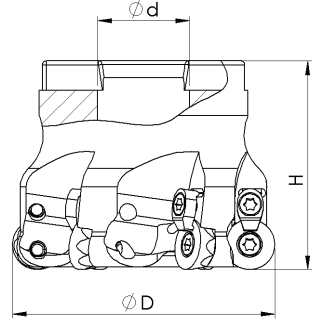

Kesici Uç Uyumluluğu Insert Suitability		Stok Stock	Takım Ölçüleri / Dimension (mm)				Uç Insert	Vida Screw	Anahtar Torx Key
RPMT 10T3 KYCR			D	Z	H	d			
SİPARİŞ KODU Ordering Code	SİPARİŞ KODU Ordering Code Inter Coolant								
X	TK 10201	✓	40	5	40	16	RPMT 10T3	M3X8	T10
X	TK 10202	✓	50	6	40	22	RPMT 10T3	M3X8	T10

**RPMT 1204 KYCR**

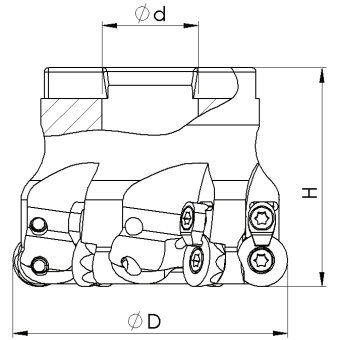

Kesici Uç Uyumluluğu Insert Suitability		Stok Stock	Takım Ölçüleri / Dimension (mm)				Uç Insert	Vida Screw	Anahtar Torx Key
RPMT 1204 KYCR			D	Z	H	d			
SİPARİŞ KODU Ordering Code	SİPARİŞ KODU Ordering Code Inter Coolant								
X	TK 10206	✓	40	4	45	16	RPMT 1204	M4X11	T15
X	TK 10210	✓	52	5	50	22	RPMT 1204	M4X11	T15
X	TK 10212	✓	63	6	50	22	RPMT 1204	M4X11	T15
X	TK 10214	✓	66	6	50	27	RPMT 1204	M4X11	T15

## RDKW 1003 - 12T3 - 1204 - 1604 - 2006 ISO

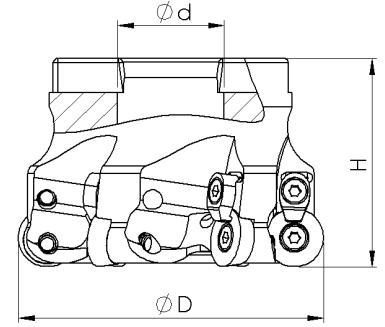

Kesici Uç Uyumluluğu Insert Suitability		Stok Stock	Takım Ölçüleri / Dimension (mm)				Uç Insert	Vida Screw	Pabuç Clamp	Vida Screw	Anahtar Torx Key
SİPARİŞ KODU Ordering Code	SİPARİŞ KODU Ordering Code Inter Coolant		D	Z	H	d					
X	TK 10168	✓	40	4	40	16	RDKW 1003	M3,5X10	-	M3,5X10	T15
X	TK 10169	✓	50	5	46	22	RDKW 1003	M3,5X10	CK14	M3,5X10	T15
X	TK 10170	✓	63	6	50	22	RDKW 1003	M3,5X10	CK14	M3,5X10	T15
X	TK 10171	✓	80	7	52	27	RDKW 1003	M3,5X10	CK14	M3,5X10	T15
X	TK 10172	✓	100	8	52	32	RDKW 1003	M3,5X10	CK14	M3,5X10	T15
X	TK 10173	✓	40	4	40	16	RDKW 12T3	M3,5X10	-	M3,5X10	T15
X	TK 10174	✓	50	5	46	22	RDKW 12T3	M3,5X10	CK14	M3,5X10	T15
X	TK 10175	✓	52	5	46	22	RDKW 12T3	M3,5X10	CK14	M3,5X10	T15
X	TK 10176	✓	63	6	50	22	RDKW 12T3	M3,5X10	CK14	M3,5X10	T15
X	TK 10177	✓	80	7	52	27	RDKW 12T3	M3,5X10	CK14	M3,5X10	T15
X	TK 10178	✓	100	8	52	32	RDKW 12T3	M3,5X10	CK14	M3,5X10	T15
TK 12425	X	✓	125	9	62	40	RDKW 12T3	M3,5X10	CK14	M3,5X10	T15
TK 13077	X	✓	160	12	62	40	RDKW 12T3	M3,5X10	CK14	M3,5X10	T15
X	TK 10179	✓	40	4	40	16	RDKW 1204	M3,5X10	-	M3,5X10	T15
X	TK 10180	✓	50	5	46	22	RDKW 1204	M3,5X10	CK14	M3,5X10	T15
X	TK 10181	✓	63	6	50	22	RDKW 1204	M3,5X10	CK14	M3,5X10	T15
X	TK 10182	✓	80	7	52	27	RDKW 1204	M3,5X10	CK14	M3,5X10	T15
X	TK 10183	✓	100	8	52	32	RDKW 1204	M3,5X10	CK14	M3,5X10	T15
TK 12760	X	✓	125	9	62	40	RDKW 1204	M3,5X10	CK14	M3,5X10	T15
X	TK 12901	✓	50	4	50	22	RDKW 1604	M5X12	CK15	M4X11	T20
X	TK 10184	✓	52	4	50	22	RDKW 1604	M5X12	CK15	M4X11	T20
X	TK 10185	✓	63	4	50	22	RDKW 1604	M5X12	CK15	M4X11	T20
X	TK 10186	✓	66	5	50	27	RDKW 1604	M5X12	CK15	M4X11	T20
X	TK 10187	✓	80	5	52	27	RDKW 1604	M5X12	CK15	M4X11	T20
X	TK 10188	✓	100	6	52	32	RDKW 1604	M5X12	CK15	M4X11	T20
TK 10189	X	✓	125	7	62	40	RDKW 1604	M5X12	CK15	M4X11	T20
TK 10190	X	✓	160	8	62	40	RDKW 1604	M5X12	CK15	M4X11	T20

## RDKW 10T3 ISO

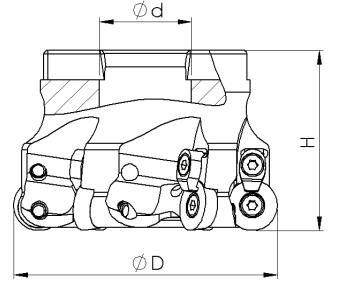

Kesici Uç Uyumluluğu Insert Suitability		Stok Stock	Takım Ölçüleri / Dimension (mm)				Uç Insert	Vida Screw	Pabuç Clamp	Vida Screw	Anahtar Torx Key
RDKW 10T3 ISO			D	Z	H	d					
SİPARİŞ KODU Ordering Code	SİPARİŞ KODU Ordering Code Inter Coolant										
X	TK 10194	✓	50	5	40	22	RDKW 10T3	M3,5X10	CK14	M3,5X10	T15
X	TK 10195	✓	63	6	40	22	RDKW 10T3	M3,5X10	CK14	M3,5X10	T15
X	TK 10196	✓	80	7	50	27	RDKW 10T3	M3,5X10	CK14	M3,5X10	T15



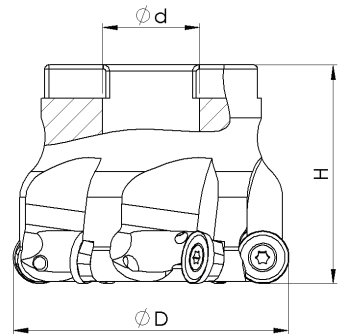

## RPMT 1204 ISO

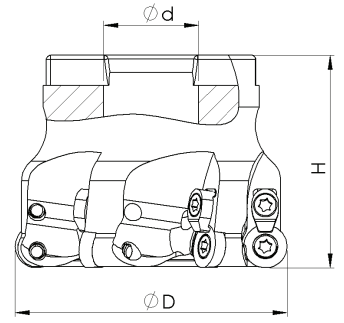

Kesici Uç Uyumluluğu Insert Suitability		Stok Stock	Takım Ölçüleri / Dimension (mm)				Uç Insert	Vida Screw	Pabuç Clamp	Vida Screw	Anahtar Torx Key
RPMT 1204 ISO			D	Z	H	d					
SİPARİŞ KODU Ordering Code	SİPARİŞ KODU Ordering Code Inter Coolant										
X	TK 11773	✓	40	4	40	16	RPMT 1204	M3,5X11	CK14	M3,5X11	T15
X	TK 11774	✓	50	5	40	22	RPMT 1204	M3,5X11	CK14	M3,5X11	T15
X	TK 11327	✓	52	5	40	22	RPMT 1204	M3,5X11	CK14	M3,5X11	T15
X	TK 11775	✓	63	6	40	22	RPMT 1204	M3,5X11	CK14	M3,5X11	T15
X	TK 12756	✓	80	7	50	27	RPMT 1204	M3,5X11	CK14	M3,5X11	T15



## RPMW 1003 ISO

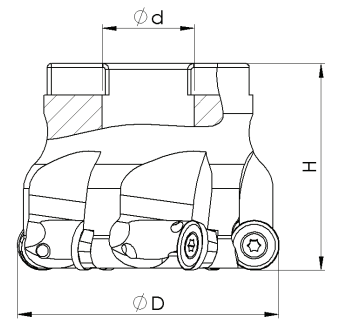

Kesici Uç Uyumluluğu Insert Suitability		Stok Stock	Takım Ölçüleri / Dimension (mm)				Uç Insert	Vida Screw	Pabuç Clamp	Vida Screw	Anahtar Torx Key
RPMW 1003 ISO			D	Z	H	d					
SİPARİŞ KODU Ordering Code	SİPARİŞ KODU Ordering Code Inter Coolant										
X	TK 11776	✓	40	4	40	16	RPMW 1003	M3,5X11	CK14	M3,5X11	T15
X	TK 9711	✓	50	5	40	22	RPMW 1003	M3,5X11	CK14	M3,5X11	T15
X	TK 9712	✓	63	6	40	22	RPMW 1003	M3,5X11	CK14	M3,5X11	T15
X	TK 11497	✓	80	7	50	27	RPMW 1003	M3,5X11	CK14	M3,5X11	T15

## RPMT 1204 TNG



Kesici Uç Uyumluluğu Insert Suitability		Stok Stock	Takım Ölçüleri / Dimension (mm)				Uç Insert	Vida Screw	Anahtar Torx Key
RPMT 1204 TNGLY			D	Z	H	d			
SİPARİŞ KODU Ordering Code	SİPARİŞ KODU Ordering Code Inter Coolant								
X	TK 10207	✓	40	4	40	16	RPMT 1204	M4X11	T15
X	TK 10209	✓	50	5	42	22	RPMT 1204	M4X11	T15
X	TK 10211	✓	63	6	42	22	RPMT 1204	M4X11	T15

**RPMT 10T3 TNG**

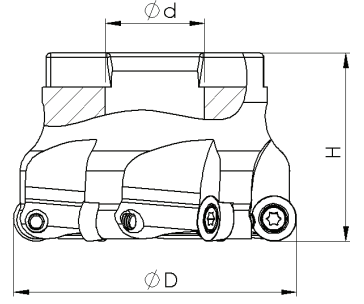

Kesici Uç Uyumluluğu Insert Suitability		Stok Stock	Takım Ölçüleri / Dimension (mm)				Uç Insert	Vida Screw	Anahtar Torx Key
RPMT 10T3 TNGLY			D	Z	H	d			
SİPARİŞ KODU Ordering Code	SİPARİŞ KODU Ordering Code Inter Cooland								
X	TK 10203	✓	40	4	42	16	RPMT 10T3	M3,5X11	T15
X	TK 10204	✓	50	5	42	22	RPMT 10T3	M3,5X11	T15
X	TK 10205	✓	63	6	42	22	RPMT 10T3	M3,5X11	T15

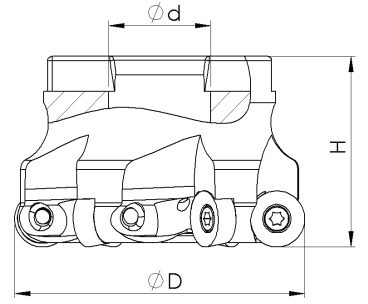
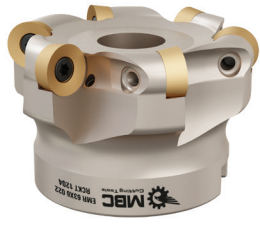

**RCKT 1204 - 1606 ZCC**

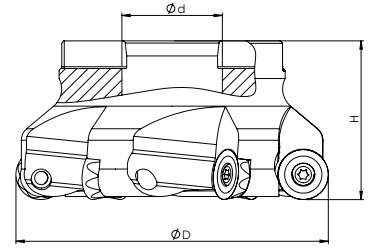

Kesici Uç Uyumluluğu Insert Suitability		Stok Stock	Takım Ölçüleri / Dimension (mm)				Uç Insert	Vida Screw	Anahtar Torx Key
RCKT 1204 - 1606 ZCC			D	Z	H	d			
SİPARİŞ KODU Ordering Code	SİPARİŞ KODU Ordering Code Inter Cooland								
X	TK 10167	✓	40	4	40	16	RCKT 1204	M3,5X11	T15
X	TK 10161	✓	50	5	40	22	RCKT 1204	M3,5X11	T15
X	TK 10162	✓	63	6	40	22	RCKT 1204	M3,5X11	T15
X	TK 10163	✓	80	7	50	27	RCKT 1204	M3,5X11	T15
X	TK 10166	✓	80	5	50	27	RCKT 1606	M6X16	T25

## ROMX 2006 WLTR



Kesici Uç Uyumluluğu Insert Suitability		Stok Stock	Takım Ölçüleri / Dimension (mm)				Uç Insert	Vida Screw	Anahtar Torx Key
ROMX 2006 WLTR			D	Z	H	d			
SİPARİŞ KODU Ordering Code	SİPARİŞ KODU Ordering Code Inter Coolant								
TK 13078	x	✓	125	6	62	40	ROMX 2006	M6X16	T25
TK 13079	x	✓	160	7	62	40	ROMX 2006	M6X16	T25
TK 13080	x	✓	200	9	62	60	ROMX 2006	M6X16	T25



# VİDALI TARAMALAR SCREW TYPE

## 90° APKT 1003 - 1604 ISO

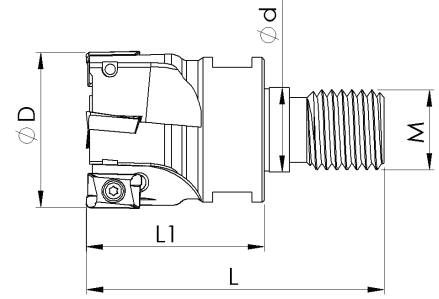

Kesici Uç Uyumluluğu Insert Suitability		Stok Stock	Takım Ölçüleri / Dimension (mm)						Uç Insert	Vida Screw	Anahtar Torx Key
90° APKT 1003 - 1604 ISO			D	Z	L1	L	d	M			
SİPARİŞ KODU Ordering Code	SİPARİŞ KODU Ordering Code Inter Coolant										
VT 11424	X	✓	16	2	33	50	8,5	M08	APKT 1003	M2,5X7	T08
VT 11423	X	✓	20	3	32	51	10,5	M10	APKT 1003	M2,5X7	T08
VT 10670	X	✓	25	3	38	60	12,5	M12	APKT 1003	M2,5X7	T08
VT 10671	X	✓	32	4	36	60	17	M16	APKT 1003	M2,5X7	T08
VT 10672	X	✓	35	4	36	60	17	M16	APKT 1003	M2,5X7	T08
VT 10674	X	✓	40	5	36	60	17	M16	APKT 1003	M2,5X7	T08
VT 10677	X	✓	25	2	38	60	12,5	M12	AKPT 1604	M3,5X8	T15
VT 10678	X	✓	32	3	44	68	17	M16	AKPT 1604	M3,5X8	T15
VT 10679	X	✓	40	4	44	68	17	M16	AKPT 1604	M3,5X8	T15

## 90° XNEX 0403 SCO

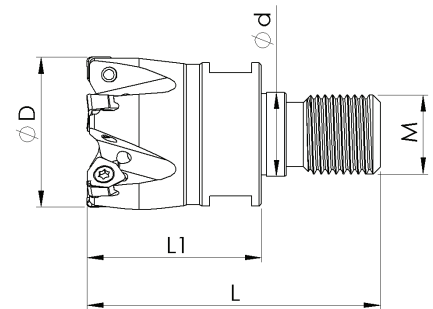

Kesici Uç Uyumluluğu Insert Suitability		Stok Stock	Takım Ölçüleri / Dimension (mm)						Uç Insert	Vida Screw	Anahtar Torx Key
90° XNEX 0403 SCO			D	Z	L1	L	d	M			
SİPARİŞ KODU Ordering Code	SİPARİŞ KODU Ordering Code Inter Coolant										
VT 10910	X	✓	25	4	28	50	12,5	M12	XNEX 0403	M3X8	T10
VT 11220	X	✓	32	4	36	60	17	M16	XNEX 0403	M3X8	T10
VT 10911	X	✓	32	5	36	60	17	M16	XNEX 0403	M3X8	T10

**XOMX 1204 SCO**

NEW

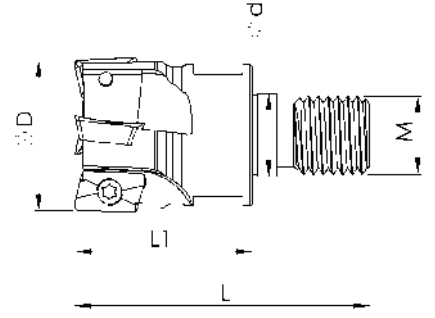

Kesici Uç Uyumluluğu Insert Suitability		Stok Stock	Takım Ölçüleri / Dimension (mm)						Uç İnsert	Vida Screw	Anahtar Torx Key
90° XOMX 1204 SCO			D	Z	L1	L	d	M			
SİPARİŞ KODU Ordering Code	SİPARİŞ KODU Ordering Code Inter Coolant										
X	VT 12395	✓	25	3	28	50	12,5	M12	XOMX 1204	M3,5X11X4.80	T15
X	VT 12396	✓	32	4	36	60	17	M16	XOMX 1204	M3,5X11X4.80	T15

**90° 3PKT 1004 TT**

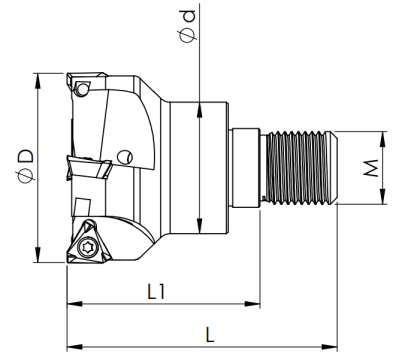

Kesici Uç Uyumluluğu Insert Suitability		Stok Stock	Takım Ölçüleri / Dimension (mm)						Uç İnsert	Vida Screw	Anahtar Torx Key
90° 3PKT 1004 TT			D	Z	L1	L	d	M			
SİPARİŞ KODU Ordering Code	SİPARİŞ KODU Ordering Code Inter Coolant										
VT 12211	X	✓	32	4	36	60	17	M16	3PKT 1004	M3X8	T10
VT 11935	X	✓	42	4	36	60	17	M16	3PKT 1004	M3X8	T10

## 90° BOMT 1304 INGRSL

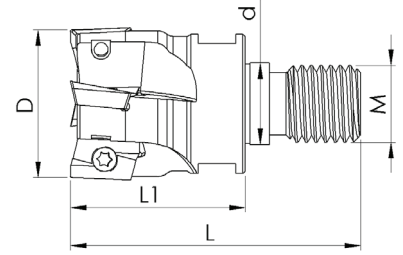

Kesici Uç Uyumluluğu Insert Suitability		Stok Stock	Takım Ölçüleri / Dimension (mm)						Uç Insert	Vida Screw	Anahtar Torx Key
90° BOMT 1304 INGRSL	SIPARIŞ KODU Ordering Code		SIPARIŞ KODU Ordering Code	D	Z	L1	L	d	M		
VT 10721	X	✓	25	3	38	60	12,5	M12	BOMT 1304	M3,5X8X4.80	T15
VT 10722	X	✓	32	4	36	60	17	M16	BOMT 1304	M3,5X8X4.80	T15

## 90° AOMT 1605 INGRSL

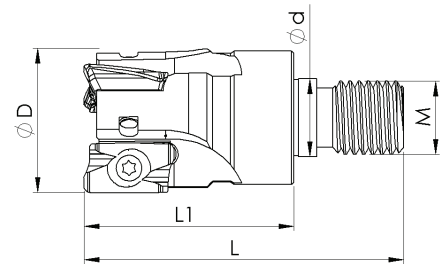

Kesici Uç Uyumluluğu Insert Suitability		Stok Stock	Takım Ölçüleri / Dimension (mm)						Uç Insert	Vida Screw	Anahtar Torx Key
90° AOMT 1605 INGRSL	SIPARIŞ KODU Ordering Code		SIPARIŞ KODU Ordering Code	D	Z	L1	L	d	M		
VT 10667	X	✓	25	2	38	60	12,5	M12	AOMT 1605	M4X10	T15
VT 10668	X	✓	32	3	44	68	17	M16	AOMT 1605	M4X10	T15
VT 10669	X	✓	40	4	44	68	17	M16	AOMT 1605	M4X10	T15

### 90° XDKT 1505 CRTZ

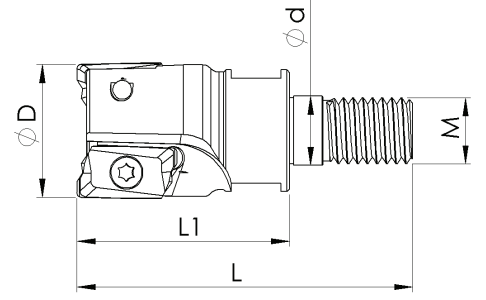

Kesici Uç Uyumluluğu Insert Suitability		Stok Stock	Takım Ölçüleri / Dimension (mm)						Uç Insert	Vida Screw	Anahtar Torx Key
90° XDKT 1505 CRTZ			D	Z	L1	L	d	M			
SİPARİŞ KODU Ordering Code	SİPARİŞ KODU Ordering Code Inter Coolant										
VT 10907	X	✓	25	2	38	60	12,5	M12	XDKT 1505	M4X10	T15
VT 10908	X	✓	32	3	36	60	17	M16	XDKT 1505	M4X10	T15

### 90° XDHT 1904 CRTZT

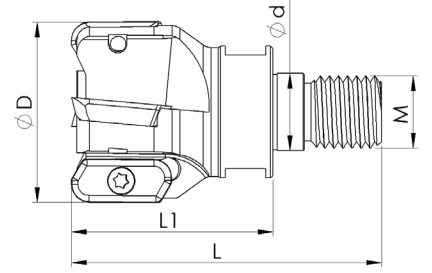

Kesici Uç Uyumluluğu Insert Suitability		Stok Stock	Takım Ölçüleri / Dimension (mm)						Uç Insert	Vida Screw	Anahtar Torx Key
90° XDHT 1904 CRTZT			D	Z	L1	L	d	M			
SİPARİŞ KODU Ordering Code	SİPARİŞ KODU Ordering Code Inter Coolant										
VT 10888	X	✓	25	2	38	60	12,5	M12	XDHT 1904	M4X10	T15
VT 10889	X	✓	40	4	36	60	17	M16	XDHT 1904	M4X10	T15

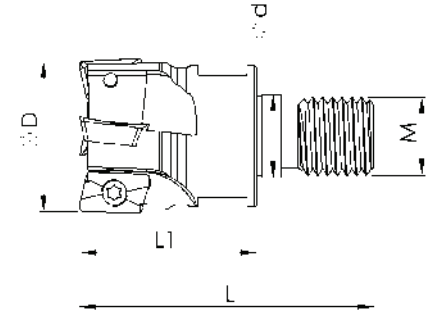

### 90° APMT 0602 - 0903 KRLY **NEW**



Kesici Uç Uyumluluğu Insert Suitability		Stok Stock	Takım Ölçüleri / Dimension (mm)						Uç Insert	Vida Screw	Anahtar Torx Key
90° APMT 0602 - 0903 KRLY			D	Z	L1	L	d	M			
SİPARİŞ KODU Ordering Code	SİPARİŞ KODU Ordering Code Inter Coolant										
VT 15372	X	✓	10	2	22	40	6,5	M6	APMT 0602	M1,8X4	T6
X	VT 14370	✓	16	2	23	40	8,5	M8	APMT 0903	M2,5X6	T8
X	VT 21247	✓	20	2	31	50	10,5	M10	APMT 0903	M2,5X6	T8
X	VT 21248	✓	25	3	38	60	12,5	M12	APMT 0903	M2,5X6	T8
X	VT 21249	✓	32	4	36	60	17	M16	APMT 0903	M2,5X6	T8

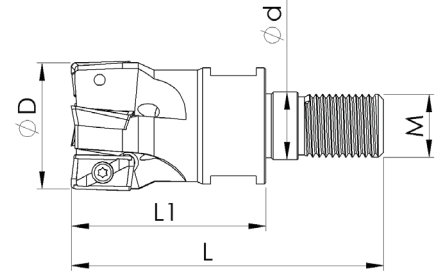

## 90° APMT 11T3 KRLY

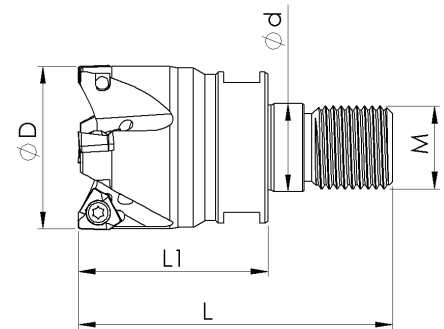

Kesici Uç Uyumluluğu Insert Suitability		Stok Stock	Takım Ölçüleri / Dimension (mm)						Uç Insert	Vida Screw	Anahtar Torx Key
90° APMT 11T3 KRLY			D	Z	L1	L	d	M			
X	VT 11458	✓	20	3	31	50	10,5	M10	APMT 11T3	M2,5X6	T08
X	VT 11460	✓	32	4	36	60	17	M16	APMT 11T3	M2,5X7	T08

## 90° XNKT 0604 KRLY



Kesici Uç Uyumluluğu Insert Suitability		Stok Stock	Takım Ölçüleri / Dimension (mm)						Uç Insert	Vida Screw	Anahtar Torx Key
90° XNKT 0604 KRLY			D	Z	L1	L	d	M			
X	VT 12470	✓	20	2	31	50	10,5	M10	XNKT 0604	M2,5X7	T08
X	VT 11277	✓	25	3	28	50	12,5	M12	XNKT 0604	M2,5X7	T08
X	VT 11278	✓	32	4	36	60	17	M16	XNKT 0604	M2,5X7	T08
X	VT 11279	✓	42	5	36	60	17	M16	XNKT 0604	M2,5X7	T08

**90° XNKT 0805 KRLY**

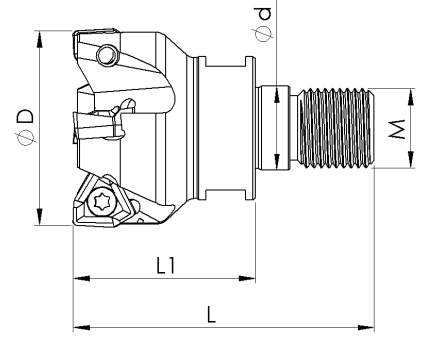

Kesici Uç Uyumluluğu Insert Suitability		Stok Stock	Takım Ölçüleri / Dimension (mm)						Uç Insert	Vida Screw	Anahtar Torx Key
SİPARİŞ KODU Ordering Code	SİPARİŞ KODU Ordering Code Inter Coolant		D	Z	L1	L	d	M			
90° XNKT 0805 KRLY											
X	VT 11280	✓	32	3	36	60	17	M16	XNKT 0805	M4X10	T15
X	VT 11507	✓	40	4	36	60	17	M16	XNKT 0805	M4X10	T15
X	VT 11281	✓	42	4	36	60	17	M16	XNKT 0805	M4X10	T15

**90° 4NKT 0603 TT**

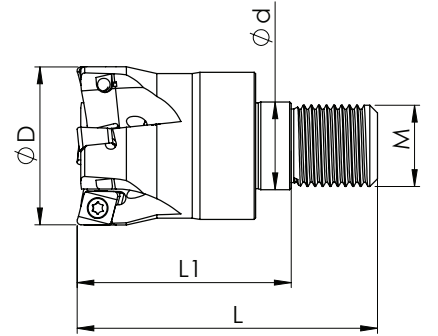

Kesici Uç Uyumluluğu Insert Suitability		Stok Stock	Takım Ölçüleri / Dimension (mm)						Uç Insert	Vida Screw	Anahtar Torx Key
SİPARİŞ KODU Ordering Code	SİPARİŞ KODU Ordering Code Inter Coolant		D	Z	L1	L	d	M			
90° 4NKT 0603 TT											
X	VT 13062	✓	21	3	31	50	17	M10	4NKT 0603	M3X8	T10
X	VT 13066	✓	26	3	28	50	12,5	M12	4NKT 0603	M3X8	T10
X	VT 13070	✓	32	4	36	60	17	M16	4NKT 0603	M3X8	T10

## RD.. 1003 - 12T3 - 1604 ISO

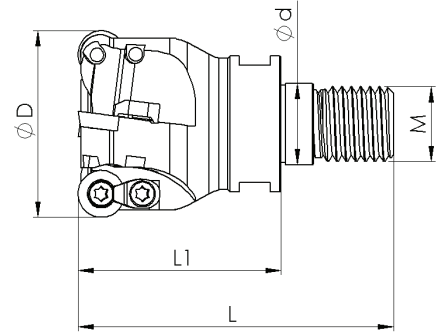

Kesici Uç Uyumluluğu Insert Suitability		Stok Stock	Takım Ölçüleri / Dimension (mm)						Uç Insert	Vida Screw	Pabuç Clamp	Vida Screw	Anahtar Torx Key
RD.. 1003 - 12T3 - 1604 ISO			D	Z	L1	L	d	M					
SİPARİŞ KODU Ordering Code	SİPARİŞ KODU Ordering Code Inter Coolant												
X	VT 11913	✓	16	2	23	40	8,5	M8	RDKW 0803	M3X8	-	-	T10
X	VT 11466	✓	20	2	31	50	10,5	M10	RD.. 1003	M3,5X8	CK14	M3,5X10	T15
X	VT 10779	✓	25	2	29	51	12,5	M12	RD.. 1003	M3,5X8	CK14	M3,5X10	T15
X	VT 10781	✓	32	4	41	65	17	M16	RD.. 1003	M3,5X8	CK14	M3,5X10	T15
X	VT 10782	✓	35	4	41	65	17	M16	RD.. 1003	M3,5X8	CK14	M3,5X10	T15
X	VT 10783	✓	40	4	44	68	17	M16	RD.. 1003	M3,5X8	CK14	M3,5X10	T15
X	VT 10784	✓	42	5	43	68	17	M16	RD.. 1003	M3,5X8	CK14	M3,5X10	T15
X	VT 10785	✓	25	2	29	51	12,5	M12	RD.. 12T3	M3,5X8	CK14	M3,5X10	T15
X	VT 10786	✓	32	3	41	65	17	M16	RD.. 12T3	M3,5X8	CK14	M3,5X10	T15
X	VT 10787	✓	35	3	41	65	17	M16	RD.. 12T3	M3,5X8	CK14	M3,5X10	T15
X	VT 10789	✓	42	4	44	68	17	M16	RD.. 12T3	M3,5X8	CK14	M3,5X10	T15
X	VT 10790	✓	32	2	41	65	17	M16	RD.. 1604	M4,5X12	CK14	M3,5X10	T20
X	VT 10791	✓	40	2	41	65	17	M16	RD.. 1604	M4,5X12	CK14	M3,5X10	T20

## RPMW 1003 ISO

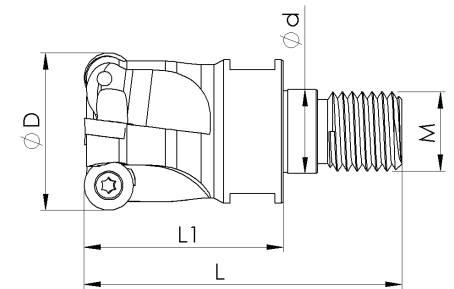

Kesici Uç Uyumluluğu Insert Suitability		Stok Stock	Takım Ölçüleri / Dimension (mm)						Uç Insert	Vida Screw	Anahtar Torx Key	
RPMW 1003 ISO			D	Z	L1	L	d	M				
SİPARİŞ KODU Ordering Code	SİPARİŞ KODU Ordering Code Inter Coolant											
X	VT 11428	✓	20	2	31	50	10,5	M10	RPMW 1003	M3,5X9		T15
X	VT 11429	✓	25	2	29	51	12,5	M12	RPMW 1003	M3,5X9		T15
X	VT 10815	✓	32	4	41	65	17	M16	RPMW 1003	M3,5X9		T15
X	VT 10816	✓	42	5	44	68	17	M16	RPMW 1003	M3,5X9		T15

**RPMT 10T3 KYCR**

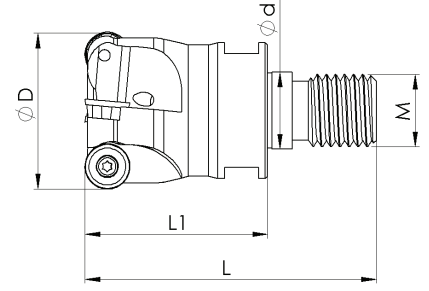

Kesici Uç Uyumluluğu Insert Suitability		Stok Stock	Takım Ölçüleri / Dimension (mm)						Uç Insert	Vida Screw	Anahtar Torx Key
RPMT 10T3 KYCR			D	Z	L1	L	d	M			
SİPARİŞ KODU Ordering Code	SİPARİŞ KODU Ordering Code Inter Coolant										
X	VT 10805	✓	25	3	28	50	12,5	M12	RPMT 10T3	M3X8	T10
X	VT 10807	✓	32	4	46	70	17	M16	RPMT 10T3	M3X8	T10
X	VT 10810	✓	42	5	46	70	17	M16	RPMT 10T3	M3X8	T10

**ROHX 1604 - 2005 ZCC**

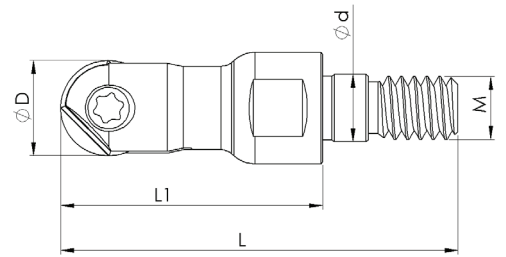

Kesici Uç Uyumluluğu Insert Suitability		Stok Stock	Takım Ölçüleri / Dimension (mm)						Uç Insert	Vida Screw	Anahtar Torx Key
ROHX 1604 - 2005 ZCC			D	Z	L1	L	d	M			
SİPARİŞ KODU Ordering Code	SİPARİŞ KODU Ordering Code Inter Coolant										
VT 10803	X	✓	16	33	38	50	8,5	M8	ROHX 1604	M5X0,5X12 D16	T20
VT 10804	X	✓	20	42	36	61	10,5	M10	ROHX 2005	M5X0,5X16 D20	T20

## XPHT 32 R16 ZCC

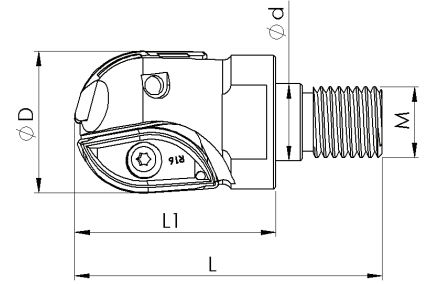

Kesici Uç Uyumluluğu Insert Suitability		Stok Stock	Takım Ölçüleri / Dimension (mm)						Uç Insert	Vida Screw	Anahtar Torx Key
XPHT 32 R16 ZCC			D	Z	L1	L	d	M			
SİPARİŞ KODU Ordering Code	SİPARİŞ KODU Ordering Code Inter Coolant										
X	VT 10917	✓	25	2	36	58	12,5	M12	XPHT 25 R12,5	M4X10	T15
X	VT 10918	✓	32	2	46	70	17	M16	XPHT 32 R16	M5X12	T20

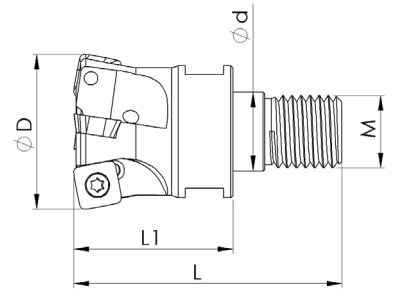

## SDMT 09T3 ZCC

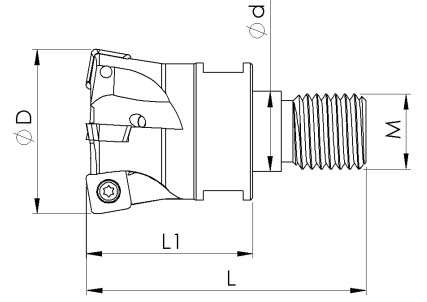

Kesici Uç Uyumluluğu Insert Suitability		Stok Stock	Takım Ölçüleri / Dimension (mm)						Uç Insert	Vida Screw	Anahtar Torx Key
SDMT 09T3 ZCC			D	Z	L1	L	d	M			
SİPARİŞ KODU Ordering Code	SİPARİŞ KODU Ordering Code Inter Coolant										
X	VT 12077	✓	25	2	28	50	12,5	M12	SDMT 09T3	M3,5X8	T15
X	VT 10835	✓	25	3	28	50	12,5	M12	SDMT 09T3	M3,5X8	T15
X	VT 10837	✓	32	3	36	60	17	M16	SDMT 09T3	M3,5X8	T15
X	VT 10839	✓	35	4	36	60	17	M16	SDMT 09T3	M3,5X8	T15
X	VT 10841	✓	40	4	36	60	17	M16	SDMT 09T3	M3,5X8	T15
X	VT 10843	✓	42	4	36	60	17	M16	SDMT 09T3	M3,5X8	T15

**SOEW 0803 PLBT**



Kesici Uç Uyumluluğu Insert Suitability		Stok Stock	Takım Ölçüleri / Dimension (mm)						Uç Insert	Vida Screw	Anahtar Torx Key
SOEW 0803 PLBT			D	Z	L1	L	d	M			
X	VT 10858	✓	25	3	28	50	12,5	M12	SOEW 0803	M3X8	T10
X	VT 10855	✓	32	4	36	60	17	M16	SOEW 0803	M3X8	T10
X	VT 10856	✓	35	4	36	60	17	M16	SOEW 0803	M3X8	T10
X	VT 10857	✓	40	5	36	60	17	M16	SOEW 0803	M3X8	T10

**SDMX 09T3 PLBT**

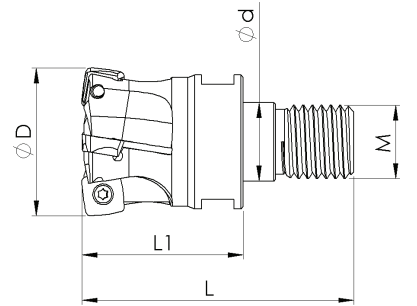

Kesici Uç Uyumluluğu Insert Suitability		Stok Stock	Takım Ölçüleri / Dimension (mm)						Uç Insert	Vida Screw	Anahtar Torx Key
SDMX 09T3 PLBT			D	Z	L1	L	d	M			
X	VT 10849	✓	25	3	28	50	12,5	M12	SDMX 09T3	M3X8	T10
X	VT 10850	✓	32	4	36	60	17	M16	SDMX 09T3	M3X8	T10
X	VT 10851	✓	35	5	36	60	17	M16	SDMX 09T3	M3X8	T10
X	VT 10852	✓	42	6	36	60	17	M16	SDMX 09T3	M3X8	T10

## XDHW 0401 - 0602 PLBT

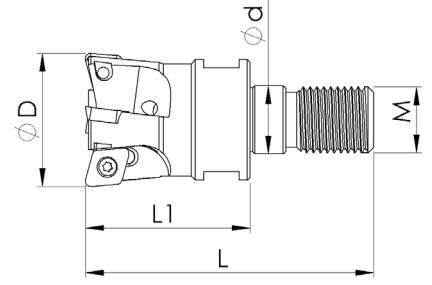

Kesici Uç Uyumluluğu Insert Suitability		Stok Stock	Takım Ölçüleri / Dimension (mm)						Uç Insert	Vida Screw	Anahtar Torx Key
XDHW 0401 - 0602 PLBT			D	Z	L1	L	d	M			
SİPARİŞ KODU Ordering Code	SİPARİŞ KODU Ordering Code Inter Coolant										
X	VT 10896	✓	16	4	23	40	8,5	M8	XDHW 0401	M1,8X4	T06
X	VT 10897	✓	16	2	25	42	8,2	M8	XDHW 0602	M2,5X6	T08
X	VT 13059	✓	17	2	25	42	8,5	M8	XDHW 0602	M2,5X6	T08
X	VT 10890	✓	20	3	31	50	10,5	M10	XDHW 0602	M2,5X6	T08
X	VT 13060	✓	21	3	30	52	10,5	M10	XDHW 0602	M2,5X6	T08
X	VT 10903	✓	25	4	30	52	12,5	M12	XDHW 0602	M2,5X6	T08
X	VT 10899	✓	32	5	35	62	17	M16	XDHW 0602	M2,5X6	T08
X	VT 10893	✓	35	5	35	62	17	M16	XDHW 0602	M2,5X6	T08
X	VT 10902	✓	42	6	30	62	17	M16	XDHW 0602	M2,5X6	T08

## SEMT 09T3 PLBT

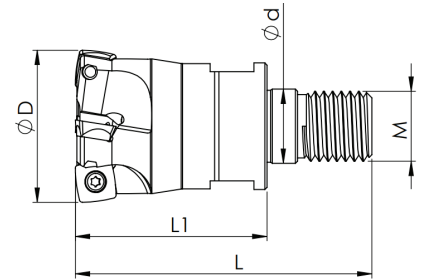

Kesici Uç Uyumluluğu Insert Suitability		Stok Stock	Takım Ölçüleri / Dimension (mm)						Uç Insert	Vida Screw	Anahtar Torx Key
SEMT 09T3 PLBT			D	Z	L1	L	d	M			
SİPARİŞ KODU Ordering Code	SİPARİŞ KODU Ordering Code Inter Coolant										
X	VT 12713	✓	35	4	44	68	17	M16	SEMT 09T3	M3X8	T10
X	VT 12714	✓	42	5	44	68	17	M16	SEMT 09T3	M3X8	T10

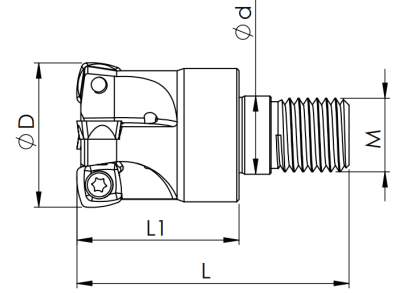

**XCNT 09T3 LMT FT**

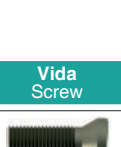
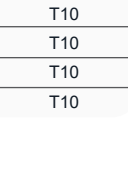

Kesici Uç Uyumluluğu Insert Suitability		Stok Stock	Takım Ölçüleri / Dimension (mm)						Uç Insert	Vida Screw	Anahtar Torx Key
XCNT 09T3 KRLY			D	Z	L1	L	d	M			
X	VT 12078	✓	32	4	36	60	17	M16	XCNT 09T3	M3,5X8	T15
X	VT 12079	✓	42	4	36	60	17	M16	XCNT 09T3	M3,5X8	T15

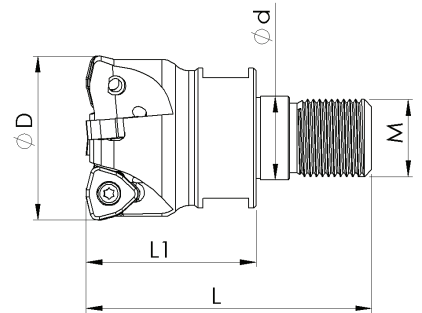

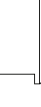
**WNMX 09T3 KRLY**

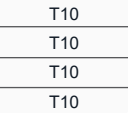

Kesici Uç Uyumluluğu Insert Suitability		Stok Stock	Takım Ölçüleri / Dimension (mm)						Uç Insert	Vida Screw	Anahtar Torx Key
WNMX 09T3 KRLY			D	Z	L1	L	d	M			
X	VT 10882	✓	25	2	28	50	12,5	M12	WNMX 09T3	M3X10	T10
X	VT 10883	✓	32	3	36	60	17	M16	WNMX 09T3	M3X10	T10
X	VT 10885	✓	35	4	36	60	17	M16	WNMX 09T3	M3X10	T10
X	VT 10886	✓	40	4	36	60	17	M16	WNMX 09T3	M3X10	T10
X	VT 12067	✓	42	4	36	60	17	M16	WNMX 09T3	M3X10	T10

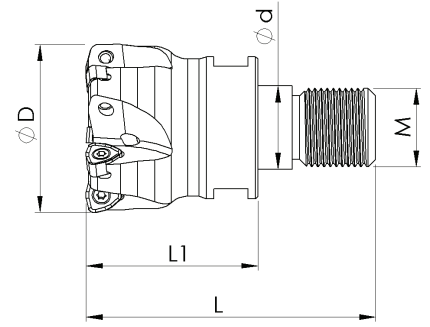

## WNMX 0603 KRLY

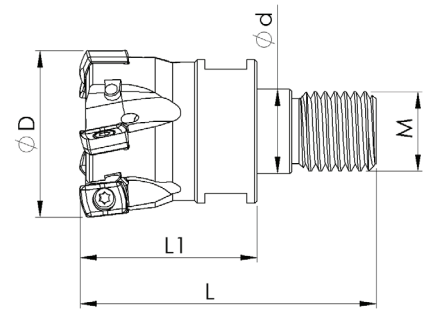

Kesici Uç Uyumluluğu Insert Suitability		Stok Stock	Takım Ölçüleri / Dimension (mm)						Uç Insert	Vida Screw	Anahtar Torx Key
SİPARİŞ KODU Ordering Code	SİPARİŞ KODU Ordering Code Inter Coolant		D	Z	L1	L	d	M			
X	VT 10877	✓	16	2	25	42	8,5	M8	WNMX 0603	M2,5X7	T08
X	VT 10878	✓	20	3	31	50	10,5	M10	WNMX 0603	M2,5X7	T08
X	VT 10879	✓	25	3	38	60	12,5	M12	WNMX 0603	M2,5X7	T08
X	VT 10880	✓	25	4	38	60	12,5	M12	WNMX 0603	M2,5X7	T08
X	VT 10881	✓	35	5	36	60	17	M16	WNMX 0603	M2,5X7	T08
X	VT 11498	✓	32	5	36	60	17	M16	WNMX 0603	M2,5X7	T08

## LNMT 0603 KRLY



Kesici Uç Uyumluluğu Insert Suitability		Stok Stock	Takım Ölçüleri / Dimension (mm)						Uç Insert	Vida Screw	Anahtar Torx Key
SİPARİŞ KODU Ordering Code	SİPARİŞ KODU Ordering Code Inter Coolant		D	Z	L1	L	d	M			
X	VT 10753	✓	35	5	36	60	17	M16	LN.. 0603	M3X8	T10
X	VT 10754	✓	40	6	36	60	17	M16	LN.. 0603	M3X8	T10

### LNMX 0603 KRLY

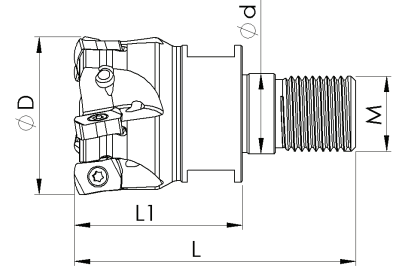

Kesici Uç Uyumluluğu Insert Suitability		Stok Stock	Takım Ölçüleri / Dimension (mm)						Uç Insert	Vida Screw	Anahtar Torx Key
LNMX 0603 KRLY			D	Z	L1	L	d	M			
SİPARİŞ KODU Ordering Code	SİPARİŞ KODU Ordering Code Inter Coolant										
X	VT 11406	✓	16	2	23	40	8,5	M8	LNMX 0603	M3X8	T10
X	VT 12693	✓	17	5	23	40	8,5	M8	LNMX 0603	M3X8	T10
X	VT 11407	✓	20	3	31	50	10,5	M10	LNMX 0603	M3X8	T10
X	VT 12694	✓	21	3	31	50	10,5	M12	LNMX 0603	M3X8	T10
X	VT 11408	✓	25	4	28	50	12,5	M12	LNMX 0603	M3X8	T10
X	VT 12695	✓	26	4	28	50	12,5	M12	LNMX 0603	M3X8	T10
X	VT 12281	✓	32	5	36	60	17	M16	LNMX 0603	M3X8	T10
X	VT 11401	✓	35	5	36	60	17	M16	LNMX 0603	M3X8	T10
X	VT 12280	✓	40	6	36	60	17	M16	LNMX 0603	M3X8	T10
X	VT 11402	✓	42	6	36	60	17	M16	LNMX 0603	M3X8	T10

### BLMP 0603 TT

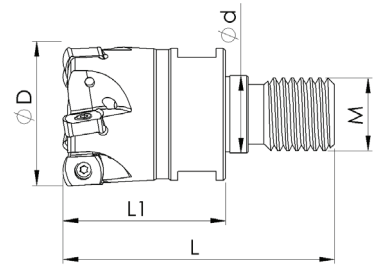

Kesici Uç Uyumluluğu Insert Suitability		Stok Stock	Takım Ölçüleri / Dimension (mm)						Uç Insert	Vida Screw	Anahtar Torx Key
BLMP 0603 TT			D	Z	L1	L	d	M			
SİPARİŞ KODU Ordering Code	SİPARİŞ KODU Ordering Code Inter Coolant										
X	VT 17185	✓	16	2	23	40	8,5	M8	BLMP 0603	M2,5X7	T08
X	VT 10715	✓	20	3	31	50	10,5	M10	BLMP 0603	M2,5X7	T08
X	VT 10716	✓	25	4	38	60	12,5	M12	BLMP 0603	M2,5X7	T08
X	VT 10717	✓	32	5	36	60	17	M16	BLMP 0603	M2,5X7	T08
X	VT 17184	✓	35	5	36	60	17	M16	BLMP 0603	M2,5X7	T08
X	VT 11217	✓	40	6	36	60	17	M16	BLMP 0603	M2,5X7	T08
X	VT 10718	✓	42	6	36	60	17	M16	BLMP 0603	M2,5X7	T08

## SOMT 1004 KYCR

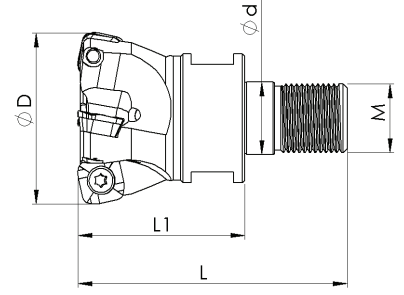

Kesici Uç Uyumluluğu Insert Suitability		Stok Stock	Takım Ölçüleri / Dimension (mm)						Uç Insert	Vida Screw	Anahtar Torx Key
SOMT 1004 KYCR			D	Z	L1	L	d	M			
SİPARİŞ KODU Ordering Code	SİPARİŞ KODU Ordering Code Inter Coolant										
X	VT 10860	✓	32	3	40	64	17	M16	SOMT 1004	M4X10	T15
X	VT 10861	✓	35	3	40	64	17	M16	SOMT 1004	M4X10	T15
X	VT 10862	✓	40	4	40	64	17	M16	SOMT 1004	M4X10	T15
X	VT 10863	✓	42	4	40	64	17	M16	SOMT 1004	M4X10	T15

## LOGU 0303 KYCR

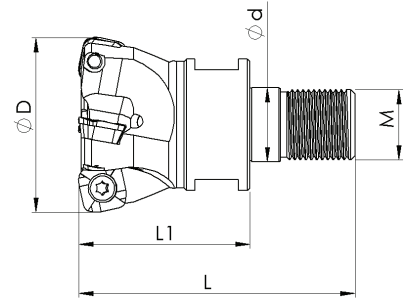

Kesici Uç Uyumluluğu Insert Suitability		Stok Stock	Takım Ölçüleri / Dimension (mm)						Uç Insert	Vida Screw	Anahtar Torx Key
LOGU 0303 KYCR			D	Z	L1	L	d	M			
SİPARİŞ KODU Ordering Code	SİPARİŞ KODU Ordering Code Inter Coolant										
X	VT 11912	✓	17	2	33	50	8,5	M8	LOGU 0303	M3X8	T08 - T10
X	VT 10759	✓	20	3	31	50	10,5	M10	LOGU 0303	M3X8	T08 - T10
X	VT 10760	✓	25	4	29	51	12,5	M12	LOGU 0303	M3X8	T08 - T10
X	VT 10761	✓	32	5	39	63	17	M16	LOGU 0303	M3X8	T08 - T10
X	VT 11329	✓	35	5	39	63	17	M16	LOGU 0303	M3X8	T08 - T10
X	VT 10762	✓	40	6	39	63	17	M16	LOGU 0303	M3X8	T08 - T10
X	VT 10763	✓	42	6	39	63	17	M16	LOGU 0303	M3X8	T08 - T10

**P26335 R10 - R14 WLTR**

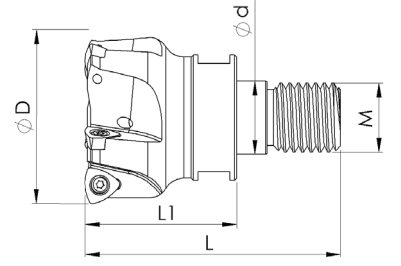

Kesici Uç Uyumluluğu Insert Suitability		Stok Stock	Takım Ölçüleri / Dimension (mm)						Uç Insert	Vida Screw	Anahtar Torx Key
P26335 R10 - R14 WLTR			D	Z	L1	L	d	M			
SİPARİŞ KODU Ordering Code	SİPARİŞ KODU Ordering Code Inter Coolant										
VT 10776	X	✓	32	3	36	60	17	M16	P26335R-10	M2,5X7	T08
X	VT 10777	✓	40	5	36	60	17	M16	P26335R-14	M4X11	T15

**LNMU 0303 TNGLY**

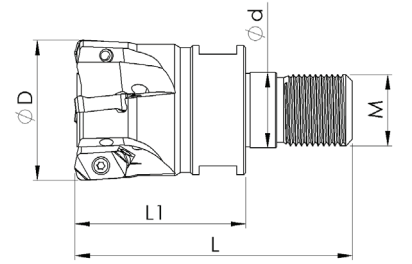

Kesici Uç Uyumluluğu Insert Suitability		Stok Stock	Takım Ölçüleri / Dimension (mm)						Uç Insert	Vida Screw	Anahtar Torx Key
LNMU 0303 TNGLY			D	Z	L1	L	d	M			
SİPARİŞ KODU Ordering Code	SİPARİŞ KODU Ordering Code Inter Coolant										
X	VT 11591	✓	20	3	31	50	10,5	M10	LNMU 0303	M2,5X7	T08
X	VT 10755	✓	25	4	29	51	12,5	M12	LNMU 0303	M2,5X7	T08
X	VT 11592	✓	32	4	39	63	17	M16	LNMU 0303	M2,5X7	T08
X	VT 10756	✓	32	5	39	63	17	M16	LNMU 0303	M2,5X7	T08
X	VT 11593	✓	35	4	39	63	17	M16	LNMU 0303	M2,5X7	T08
X	VT 11286	✓	40	6	39	63	17	M16	LNMU 0303	M2,5X7	T08
X	VT 11594	✓	42	5	39	63	17	M16	LNMU 0303	M2,5X7	T08
X	VT 12230	✓	42	6	39	63	17	M16	LNMU 0303	M2,5X7	T08

## BNGX 10T3 PRMT

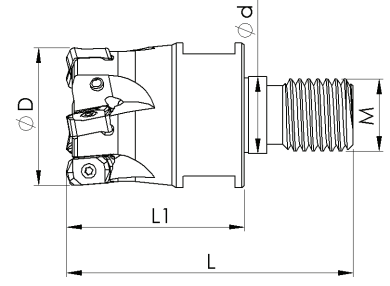

Kesici Uç Uyumluluğu Insert Suitability		Stok Stock	Takım Ölçüleri / Dimension (mm)						Uç Insert	Vida Screw	Anahtar Torx Key
BNGX 10T3 PRMT			D	Z	L1	L	d	M			
SİPARİŞ KODU Ordering Code	SİPARİŞ KODU Ordering Code Inter Cooland										
X	VT 10719	✓	25	4	28	50	12,5	M12	BNGX 10T3	M2,5X7	T08
X	VT 10720	✓	32	5	38	62	17	M16	BNGX 10T3	M2,5X7	T08

## SDMT 1004 BHLR

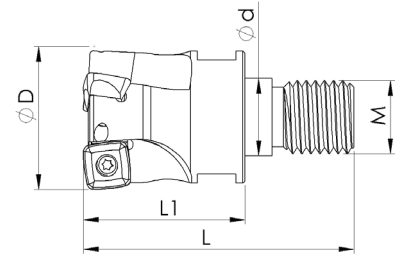

Kesici Uç Uyumluluğu Insert Suitability		Stok Stock	Takım Ölçüleri / Dimension (mm)						Uç Insert	Vida Screw	Anahtar Torx Key
SDMT 1004 BHLR			D	Z	L1	L	d	M			
SİPARİŞ KODU Ordering Code	SİPARİŞ KODU Ordering Code Inter Cooland										
X	VT 10845	✓	25	2	28	50	12,5	M12	SDMT 1004	M3X8	T10
X	VT 10844	✓	32	3	34	60	17	M16	SDMT 1004	M3X8	T10



# U - DRILLER U - DRILLS

## DRILL WCM. D2

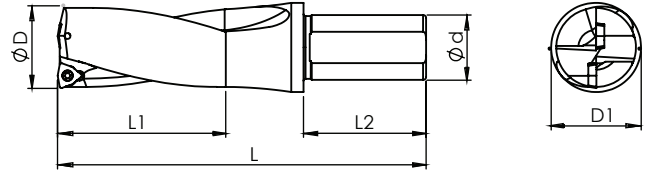

Kesici Uç Uyumluluğu Insert Suitability		Stok Stock	Takım Ölçüleri / Dimension (mm)					Uç Insert	Vida Screw	Anahtar Torx Key	
DRILL WCM. D2			D	d	d1	L	L1	L2			
SİPARİŞ KODUR Ordering Code	SİPARİŞ KODU Ordering Code Inter Coolant										
X	UDRL 10928	✓	16	25	34	110	32	50	WCM 030208	M2,5X6	T08
X	UDRL 12984	✓	16,5	25	34	112	33	56	WCM 030208	M2,5X6	T08
X	UDRL 10929	✓	17	25	34	112	34	56	WCM 030208	M2,5X6	T08
X	UDRL 12985	✓	17,5	25	34	114	35	56	WCM 030208	M2,5X6	T08
X	UDRL 10930	✓	18	25	34	114	36	56	WCM 030208	M2,5X6	T08
X	UDRL 10931	✓	18,5	25	34	116	37	56	WCM 030208	M2,5X6	T08
X	UDRL 10932	✓	19	25	34	116	38	56	WCM 030208	M2,5X6	T08
X	UDRL 10933	✓	19,5	25	34	119	39	56	WCM 030208	M2,5X6	T08
X	UDRL 10934	✓	20	25	34	119	40	56	WCM 040208	M2,5X7	T08
X	UDRL 12601	✓	20,5	25	34	122	41	56	WCM 040208	M2,5X7	T08
X	UDRL 10935	✓	21	25	34	122	42	56	WCM 040208	M2,5X7	T08
X	UDRL 10936	✓	21	25	34	125	43	56	WCM 040208	M2,5X7	T08
X	UDRL 10937	✓	22	25	34	125	44	56	WCM 040208	M2,5X7	T08
X	UDRL 14242	✓	22,5	25	34	128	45	56	WCM 040208	M2,5X7	T08
X	UDRL 10938	✓	23	25	34	128	46	56	WCM 040208	M2,5X7	T08
X	UDRL 14243	✓	23,5	25	34	129	47	56	WCM 040208	M2,5X7	T08
X	UDRL 10939	✓	24	25	34	129	48	56	WCM 050308	M3X8	T10
X	UDRL 14244	✓	24,5	25	34	131	49	56	WCM 050308	M3X8	T10
X	UDRL 10940	✓	25	25	34	131	50	56	WCM 050308	M3X8	T10
X	UDRL 14245	✓	25,5	25	34	134	53	56	WCM 050308	M3X8	T10
X	UDRL 10941	✓	26	25	34	134	52	56	WCM 050308	M3X8	T10
X	UDRL 12976	✓	26,5	25	34	137	53	56	WCM 050308	M3X8	T10
X	UDRL 10942	✓	27	25	34	137	54	56	WCM 050308	M3X8	T10
X	UDRL 14246	✓	27,5	25	34	140	55	56	WCM 050308	M3X8	T10
X	UDRL 10943	✓	28	25	34	140	56	56	WCM 050308	M3X8	T10
X	UDRL 14247	✓	28,5	25	34	140	57	56	WCM 050308	M3X8	T10
X	UDRL 10944	✓	29	25	34	143	58	56	WCM 050308	M3X8	T10
X	UDRL 14248	✓	28,5	25	34	143	59	60	WCM 050308	M3X8	T10
X	UDRL 10945	✓	30	32	44	150	60	60	WCM 06T308	M3,5X11X4.8	T15
X	UDRL 10946	✓	31	32	44	153	62	60	WCM 06T308	M3,5X11X4.8	T15
X	UDRL 10947	✓	32	32	44	156	64	60	WCM 06T308	M3,5X11X4.8	T15
X	UDRL 10948	✓	33	32	44	159	66	60	WCM 06T308	M3,5X11X4.8	T15
X	UDRL 10949	✓	34	32	44	162	68	60	WCM 06T308	M3,5X11X4.8	T15
X	UDRL 10950	✓	35	32	44	165	70	60	WCM 06T308	M3,5X11X4.8	T15
X	UDRL 10951	✓	36	32	44	168	72	60	WCM 06T308	M3,5X11X4.8	T15
X	UDRL 10952	✓	37	32	44	171	74	60	WCM 06T308	M3,5X11X4.8	T15
X	UDRL 10953	✓	38	32	44	174	76	60	WCM 06T308	M3,5X11X4.8	T15
X	UDRL 10954	✓	39	32	44	177	78	60	WCM 06T308	M3,5X11X4.8	T15
X	UDRL 10955	✓	40	32	44	180	80	60	WCM 06T308	M3,5X11X4.8	T15
X	UDRL 10956	✓	41	32	44	183	82	60	WCM 06T308	M3,5X11X4.8	T15
X	UDRL 10957	✓	42	32	44	186	84	60	WCM 06T308	M3,5X11X4.8	T15
X	UDRL 10958	✓	43	32	44	189	86	60	WCM 06T308	M3,5X11X4.8	T15
X	UDRL 10959	✓	44	32	44	192	88	60	WCM 06T308	M3,5X11X4.8	T15

### DRILL WCM. D2

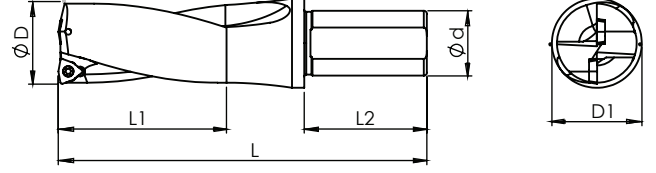

Kesici Uç Uyumluluğu Insert Suitability		Stok Stock	Takım Ölçüleri / Dimension (mm)					Uç Insert	Vida Screw	Anahtar Torx Key	
DRILL WCM. D2			D	d	d1	L	L1	L2			
X	UDRL 10960	✓	45	40	54	195	90	70	WCM 080412	M4X11	T15
X	UDRL 10961	✓	46	40	54	198	92	70	WCM 080412	M4X11	T15
X	UDRL 10962	✓	47	40	54	201	94	70	WCM 080412	M4X11	T15
X	UDRL 10963	✓	48	40	54	204	96	70	WCM 080412	M4X11	T15
X	UDRL 10964	✓	49	40	54	207	98	70	WCM 080412	M4X11	T15
X	UDRL 10965	✓	50	40	54	210	100	70	WCM 080412	M4X11	T15

### DRILL WCM. D3

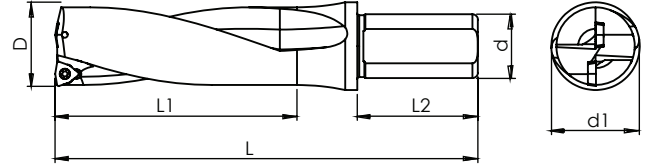

Kesici Uç Uyumluluğu Insert Suitability		Stok Stock	Takım Ölçüleri / Dimension (mm)					Uç Insert	Vida Screw	Anahtar Torx Key	
DRILL WCM. D3			D	d	d1	L	L1	L2			
X	UDRL 10972	✓	15,5	25	34	126	46,5	56	WCM 030208	M2,5X6	T08
X	UDRL 10973	✓	16	25	34	126	48	56	WCM 030208	M2,5X6	T08
X	UDRL 10974	✓	16,5	25	34	129	49,5	56	WCM 030208	M2,5X6	T08
X	UDRL 10975	✓	17	25	34	129	51	56	WCM 030208	M2,5X6	T08
X	UDRL 10976	✓	17,5	25	34	132	52,5	56	WCM 030208	M2,5X6	T08
X	UDRL 10977	✓	18	25	34	132	54	56	WCM 030208	M2,5X6	T08
X	UDRL 10978	✓	18,5	25	34	135	55,5	56	WCM 030208	M2,5X6	T08
X	UDRL 10979	✓	19	25	34	135	57	56	WCM 030208	M2,5X6	T08
X	UDRL 10980	✓	19,5	25	34	139	58,5	56	WCM 030208	M2,5X6	T08
X	UDRL 10981	✓	20	25	34	139	60	56	WCM 040208	M2,5X7	T08
X	UDRL 10982	✓	20,5	25	34	143	61,5	56	WCM 040208	M2,5X7	T08
X	UDRL 10983	✓	21	25	34	143	63	56	WCM 040208	M2,5X7	T08
X	UDRL 10984	✓	21,5	25	34	147	64,5	56	WCM 040208	M2,5X7	T08
X	UDRL 10985	✓	22	25	34	147	66	56	WCM 040208	M2,5X7	T08
X	UDRL 10986	✓	22,5	25	34	151	67,5	56	WCM 040208	M2,5X7	T08
X	UDRL 10987	✓	23	25	34	151	69	56	WCM 040208	M2,5X7	T08
X	UDRL 10988	✓	23,5	25	34	153	70,5	56	WCM 040208	M2,5X7	T08
X	UDRL 10989	✓	24	25	34	153	72	56	WCM 050308	M3X8	T10
X	UDRL 10990	✓	24,5	25	34	156	73,5	56	WCM 050308	M3X8	T10
X	UDRL 10991	✓	25	25	34	156	75	56	WCM 050308	M3X8	T10
X	UDRL 10992	✓	25,5	25	34	160	76,5	56	WCM 050308	M3X8	T10
X	UDRL 10993	✓	26	25	34	160	78	56	WCM 050308	M3X8	T10
X	UDRL 10994	✓	26,5	25	34	164	79,5	56	WCM 050308	M3X8	T10

## DRILL WCM. D3

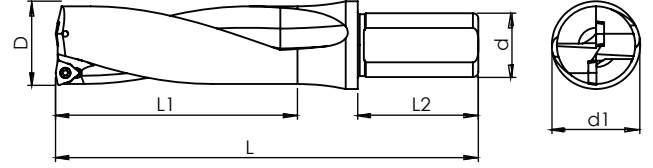

Kesici Uç Uyumluluğu Insert Suitability		Stok Stock	Takım Ölçüleri / Dimension (mm)						Uç Insert	Vida Screw	Anahtar Torx Key
DRILL WCM. D3			D	d	d1	L	L1	L2			
SİPARİŞ KODU Ordering Code	SİPARİŞ KODU Ordering Code Inter Coolant										
X	UDRL 10995	✓	27	25	34	164	81	56	WCM 050308	M3X8	T10
X	UDRL 10996	✓	27,5	25	34	168	82,5	56	WCM 050308	M3X8	T10
X	UDRL 10997	✓	28	25	34	168	84	56	WCM 050308	M3X8	T10
X	UDRL 10998	✓	28,5	25	34	172	85,5	56	WCM 050308	M3X8	T10
X	UDRL 10999	✓	29	25	34	172	87	56	WCM 050308	M3X8	T10
X	UDRL 11000	✓	29,5	25	34	172	88,5	56	WCM 050308	M3X8	T10
X	UDRL 11001	✓	30	32	44	180	90	60	WCM 06T308	M3,5X11X4.8	T15
X	UDRL 12407	✓	30,5	32	44	184	91,5	60	WCM 06T308	M3,5X11X4.8	T15
X	UDRL 11002	✓	31	32	44	184	93	60	WCM 06T308	M3,5X11X4.8	T15
X	UDRL 12406	✓	31,5	32	44	188	94,5	60	WCM 06T308	M3,5X11X4.8	T15
X	UDRL 11003	✓	32	32	44	188	96	60	WCM 06T308	M3,5X11X4.8	T15
X	UDRL 12405	✓	32,5	32	44	192	97,5	60	WCM 06T308	M3,5X11X4.8	T15
X	UDRL 11004	✓	33	32	44	192	99	60	WCM 06T308	M3,5X11X4.8	T15
X	UDRL 12404	✓	33,5	32	44	192	100,5	60	WCM 06T308	M3,5X11X4.8	T15
X	UDRL 11005	✓	34	32	44	192	102	60	WCM 06T308	M3,5X11X4.8	T15
X	UDRL 12403	✓	34,5	32	44	200	103,5	60	WCM 06T308	M3,5X11X4.8	T15
X	UDRL 11006	✓	35	32	44	200	105	60	WCM 06T308	M3,5X11X4.8	T15
X	UDRL 12402	✓	35,5	32	44	204	106,5	60	WCM 06T308	M3,5X11X4.8	T15
X	UDRL 11007	✓	36	32	44	204	108	60	WCM 06T308	M3,5X11X4.8	T15
X	UDRL 12401	✓	36,5	32	44	208	109,5	60	WCM 06T308	M3,5X11X4.8	T15
X	UDRL 11008	✓	37	32	44	208	111	60	WCM 06T308	M3,5X11X4.8	T15
X	UDRL 12400	✓	37,5	32	44	212	112,5	60	WCM 06T308	M3,5X11X4.8	T15
X	UDRL 11009	✓	38	32	44	212	114	60	WCM 06T308	M3,5X11X4.8	T15
X	UDRL 12399	✓	38,5	32	44	216	115,5	60	WCM 06T308	M3,5X11X4.8	T15
X	UDRL 11010	✓	39	32	44	216	117	60	WCM 06T308	M3,5X11X4.8	T15
X	UDRL 14249	✓	39,5	32	44	220	118,5	60	WCM 06T308	M3,5X11X4.8	T15
X	UDRL 11011	✓	40	32	44	220	120	60	WCM 06T308	M3,5X11X4.8	T15
X	UDRL 11012	✓	41	32	44	223	123	60	WCM 06T308	M3,5X11X4.8	T15
X	UDRL 11013	✓	42	32	44	226	126	60	WCM 06T308	M3,5X11X4.8	T15
X	UDRL 11014	✓	43	32	44	229	129	60	WCM 06T308	M3,5X11X4.8	T15
X	UDRL 11015	✓	44	32	44	232	132	60	WCM 06T308	M3,5X11X4.8	T15
X	UDRL 11016	✓	45	40	54	245	135	70	WCM 080412	M4X11	T15
X	UDRL 11017	✓	46	40	54	248	138	70	WCM 080412	M4X11	T15
X	UDRL 11018	✓	47	40	54	251	141	70	WCM 080412	M4X11	T15
X	UDRL 11019	✓	48	40	54	254	144	70	WCM 080412	M4X11	T15
X	UDRL 11020	✓	49	40	54	257	147	70	WCM 080412	M4X11	T15
X	UDRL 11021	✓	50	40	54	260	150	70	WCM 080412	M4X11	T15
X	UDRL 16708	✓	51	40	54	263	153	70	WCM 080412	M4X11	T15
X	UDRL 16709	✓	52	40	54	266	156	70	WCM 080412	M4X11	T15
X	UDRL 16710	✓	53	40	54	269	159	70	WCM 080412	M4X11	T15
X	UDRL 16711	✓	54	40	54	271	162	70	WCM 080412	M4X11	T15
X	UDRL 16712	✓	55	40	54	274	165	70	WCM 080412	M4X11	T15
X	UDRL 16713	✓	56	40	54	277	168	70	WCM 080412	M4X11	T15
X	UDRL 16714	✓	57	40	54	280	171	70	WCM 080412	M4X11	T15
X	UDRL 16715	✓	58	40	54	283	174	70	WCM 080412	M4X11	T15
X	UDRL 16716	✓	59	40	54	286	177	70	WCM 080412	M4X11	T15
X	UDRL 16717	✓	60	40	54	289	200	70	WCM 080412	M4X11	T15

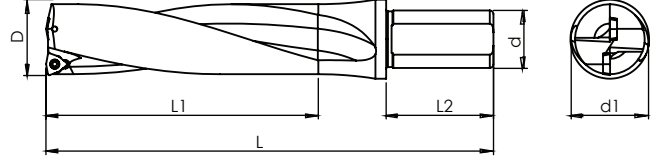

### DRILL WCM. D4



Kesici Uç Uyumluluğu Insert Suitability		Stok Stock	Takım Ölçüleri / Dimension (mm)						Uç Insert	Vida Screw	Anahtar Torx Key
DRILL WCM. D4			D	d	d1	L	L1	L2			
SİPARİŞ KODU Ordering Code	SİPARİŞ KODU Ordering Code Inter Cooland										
X	UDRL 11419	✓	15,5	25	34	142	62	56	WCM 030208	M2,5X6	T08
X	UDRL 11022	✓	16	25	34	142	64	56	WCM 030208	M2,5X6	T08
X	UDRL 11023	✓	17	25	34	146	68	56	WCM 030208	M2,5X6	T08
X	UDRL 11024	✓	17,5	25	34	150	72	56	WCM 030208	M2,5X6	T08
X	UDRL 11025	✓	18	25	34	150	72	56	WCM 030208	M2,5X6	T08
X	UDRL 11026	✓	19	25	34	154	76	56	WCM 030208	M2,5X6	T08
X	UDRL 11027	✓	19,5	25	34	159	80	56	WCM 030208	M2,5X6	T08
X	UDRL 11028	✓	20	25	34	159	80	56	WCM 040208	M2,5X7	T08
X	UDRL 11029	✓	21	25	34	164	84	56	WCM 040208	M2,5X7	T08
X	UDRL 11030	✓	22	25	34	169	88	56	WCM 040208	M2,5X7	T08
X	UDRL 11031	✓	23	25	34	174	92	56	WCM 040208	M2,5X7	T08
X	UDRL 11420	✓	23,5	25	34	174	94	56	WCM 040208	M2,5X7	T08
X	UDRL 11032	✓	24	25	34	177	96	56	WCM 050308	M3X8	T10
X	UDRL 11033	✓	25	25	34	181	100	56	WCM 050308	M3X8	T10
X	UDRL 11034	✓	25,5	25	34	181	102	56	WCM 050308	M3X8	T10
X	UDRL 11035	✓	26	25	34	186	104	56	WCM 050308	M3X8	T10
X	UDRL 11036	✓	27	25	34	191	108	56	WCM 050308	M3X8	T10
X	UDRL 11421	✓	27,5	25	34	191	110	56	WCM 050308	M3X8	T10
X	UDRL 11037	✓	28	25	34	196	112	56	WCM 050308	M3X8	T10
X	UDRL 11038	✓	29	25	34	201	116	56	WCM 050308	M3X8	T10
X	UDRL 17011	✓	29,5	25	34	201	116	56	WCM 050308	M3X8	T10
X	UDRL 11039	✓	30	32	44	210	120	60	WCM 06T308	M3,5X11X4,8	T15
X	UDRL 11040	✓	31	32	44	215	124	60	WCM 06T308	M3,5X11X4,8	T15
X	UDRL 12458	✓	31,5	32	44	220	126	60	WCM 06T308	M3,5X11X4,8	T15
X	UDRL 11041	✓	32	32	44	220	128	60	WCM 06T308	M3,5X11X4,8	T15
X	UDRL 11042	✓	33	32	44	225	132	60	WCM 06T308	M3,5X11X4,8	T15
X	UDRL 11422	✓	33,5	32	44	225	134	60	WCM 06T308	M3,5X11X4,8	T15
X	UDRL 11043	✓	34	32	44	230	136	60	WCM 06T308	M3,5X11X4,8	T15
X	UDRL 11044	✓	35	32	44	235	140	60	WCM 06T308	M3,5X11X4,8	T15
X	UDRL 11045	✓	36	32	44	238	144	60	WCM 06T308	M3,5X11X4,8	T15
X	UDRL 11046	✓	37	32	44	241	148	60	WCM 06T308	M3,5X11X4,8	T15
X	UDRL 11047	✓	38	32	44	244	152	60	WCM 06T308	M3,5X11X4,8	T15
X	UDRL 12460	✓	38,5	32	44	247	154	60	WCM 06T308	M3,5X11X4,8	T15
X	UDRL 11048	✓	39	32	44	247	156	60	WCM 06T308	M3,5X11X4,8	T15
X	UDRL 11049	✓	40	32	44	250	160	60	WCM 06T308	M3,5X11X4,8	T15
X	UDRL 11050	✓	41	32	44	253	164	60	WCM 06T308	M3,5X11X4,8	T15
X	UDRL 12461	✓	41,5	32	44	256	166	60	WCM 06T308	M3,5X11X4,8	T15
X	UDRL 11051	✓	42	32	44	256	168	60	WCM 06T308	M3,5X11X4,8	T15
X	UDRL 11052	✓	43	32	44	259	172	60	WCM 06T308	M3,5X11X4,8	T15
X	UDRL 11053	✓	44	32	44	262	176	60	WCM 06T308	M3,5X11X4,8	T15
X	UDRL 11054	✓	45	40	54	265	180	70	WCM 080412	M4X11	T15
X	UDRL 11055	✓	46	40	54	268	184	70	WCM 080412	M4X11	T15
X	UDRL 11056	✓	47	40	54	271	188	70	WCM 080412	M4X11	T15
X	UDRL 11057	✓	48	40	54	274	192	70	WCM 080412	M4X11	T15
X	UDRL 11058	✓	49	40	54	277	196	70	WCM 080412	M4X11	T15
X	UDRL 11059	✓	50	40	54	280	200	70	WCM 080412	M4X11	T15

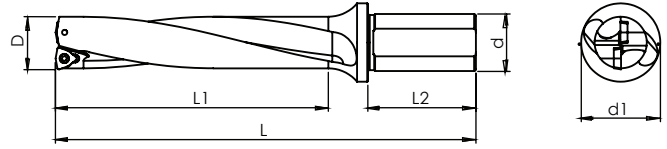

## DRILL WCM. D5

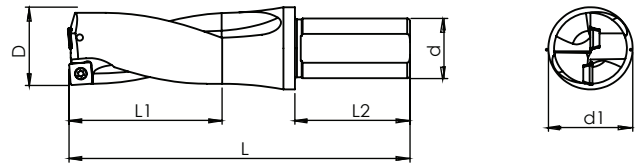
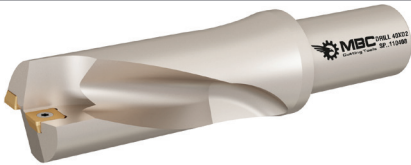

Kesici Uç Uyumluluğu Insert Suitability		Stok Stock	Takım Ölçüleri / Dimension (mm)						Uç İnsert	Vida Screw	Anahtar Torx Key
DRILL WCM. D5			D	d	d1	L	L1	L2			
SİPARİŞ KODU Ordering Code	SİPARİŞ KODU Ordering Code Inter Cooland										
X	UDRL 21312	✓	16	25	34	153	80	56	WCM 030208	M2,5X6	T08
X	UDRL 16812	✓	17	25	34	158	85	56	WCM 030208	M2,5X6	T08
X	UDRL 16813	✓	18	25	34	163	90	56	WCM 030208	M2,5X6	T08
X	UDRL 16814	✓	19	25	34	168	95	56	WCM 030208	M2,5X6	T08
X	UDRL 16815	✓	20	25	34	174	100	56	WCM 040208	M2,5X7	T08
X	UDRL 16816	✓	21	25	34	180	105	56	WCM 040208	M2,5X7	T08
X	UDRL 16817	✓	22	25	34	186	110	56	WCM 040208	M2,5X7	T08
X	UDRL 16818	✓	23	25	34	192	115	56	WCM 040208	M2,5X7	T08
X	UDRL 16819	✓	24	25	34	196	120	56	WCM 050308	M3X8	T10
X	UDRL 16820	✓	25	25	34	200	125	56	WCM 050308	M3X8	T10
X	UDRL 16821	✓	26	25	34	206	130	56	WCM 050308	M3X8	T10
X	UDRL 11060	✓	27	25	34	212	135	56	WCM 050308	M3X8	T10
X	UDRL 11061	✓	28	25	34	218	140	56	WCM 050308	M3X8	T10
X	UDRL 11062	✓	29	25	34	224	145	56	WCM 050308	M3X8	T10
X	UDRL 11063	✓	30	32	44	233	150	60	WCM 06T308	M3,5X11X4.8	T15
X	UDRL 11064	✓	50,5	40	54	283	202	70	WCM 080412	M4X11	T15
X	UDRL 11065	✓	51	40	54	286	204	70	WCM 080412	M4X11	T15
X	UDRL 11066	✓	52	40	54	289	208	70	WCM 080412	M4X11	T15
X	UDRL 11067	✓	53	40	54	291	212	70	WCM 080412	M4X11	T15
X	UDRL 11068	✓	54	40	54	294	216	70	WCM 080412	M4X11	T15
X	UDRL 11069	✓	55	40	54	297	220	70	WCM 080412	M4X11	T15
X	UDRL 11070	✓	56	40	54	300	224	70	WCM 080412	M4X11	T15
X	UDRL 11071	✓	57	40	54	303	228	70	WCM 080412	M4X11	T15
X	UDRL 11072	✓	58	40	54	306	232	70	WCM 080412	M4X11	T15
X	UDRL 11073	✓	59	40	54	309	236	70	WCM 080412	M4X11	T15
X	UDRL 11074	✓	60	40	54	311	240	70	WCM 080412	M4X11	T15

## DRILL SP.. D2



Kesici Uç Uyumluluğu Insert Suitability		Stok Stock	Takım Ölçüleri / Dimension (mm)						Uç İnsert	Vida Screw	Anahtar Torx Key
DRILL SP.. D2			D	d	d1	L	L1	L2			
SİPARİŞ KODU Ordering Code	SİPARİŞ KODU Ordering Code Inter Cooland										
X	UDRL 12219	✓	12,5	20	25	94	25	50	SP.. 050204	M2X5	T06
X	UDRL 8052	✓	13	20	25	94	26	50	SP.. 050204	M2X5	T06
X	UDRL 14250	✓	13,5	20	25	94	27	50	SP.. 050204	M2X5	T06
X	UDRL 8053	✓	14	20	25	97	28	50	SP.. 050204	M2X5	T06
X	UDRL 12271	✓	14,5	20	25	100	29	50	SP.. 050204	M2X5	T06
X	UDRL 8054	✓	15	20	25	100	30	50	SP.. 050204	M2X5	T06
X	UDRL 12684	✓	15,5	25	34	110	31	56	SP.. 050204	M2X5	T06
X	UDRL 8055	✓	16	25	34	110	32	56	SP.. 060204	M2,2X5	T06
X	UDRL 12051	✓	16,5	25	34	112	33	56	SP.. 060204	M2,2X5	T06
X	UDRL 8056	✓	17	25	34	112	34	56	SP.. 060204	M2,2X5	T06
X	UDRL 12052	✓	17,5	25	34	113	35	56	SP.. 060204	M2,2X5	T06
X	UDRL 8057	✓	18	25	34	114	36	56	SP.. 060204	M2,2X5	T06

### DRILL SP.. D2

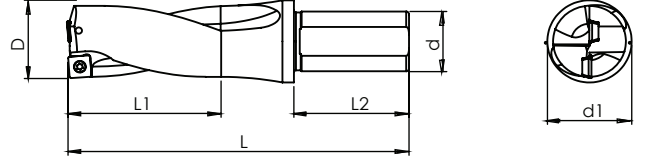

Kesici Uç Uyumluluğu Insert Suitability		Stok Stock	Takım Ölçüleri / Dimension (mm)						Uç İnsert	Vida Screw	Anahtar Torx Key
DRILL SP.. D2			D	d	d1	L	L1	L2			
SİPARİŞ KODU Ordering Code	SİPARİŞ KODU Ordering Code Inter Coolant										
X	UDRL 12050	✓	18,5	25	34	116	37	56	SP.. 060204	M2,2X5	T06
X	UDRL 8058	✓	19	25	34	116	38	56	SP.. 060204	M2,2X5	T06
X	UDRL 8059	✓	19,5	25	34	119	39	56	SP.. 060204	M2,2X5	T06
X	UDRL 8060	✓	20	25	34	119	40	56	SP.. 060204	M2,2X5	T06
X	UDRL 8061	✓	20,5	25	34	122	41	56	SP.. 060204	M2,2X5	T06
X	UDRL 8062	✓	21	25	34	122	42	56	SP.. 060204	M2,2X5	T06
X	UDRL 12049	✓	21,5	25	34	125	43	56	SP.. 060204	M2,2X5	T06
X	UDRL 8063	✓	22	25	34	125	44	56	SP.. 07T308	M2,5X7	T08
X	UDRL 14251	✓	22,5	25	34	128	45	56	SP.. 07T308	M2,5X7	T08
X	UDRL 8064	✓	23	25	34	128	46	56	SP.. 07T308	M2,5X7	T08
X	UDRL 14252	✓	23,5	25	34	129	47	56	SP.. 07T308	M2,5X7	T08
X	UDRL 8065	✓	24	25	34	129	48	56	SP.. 07T308	M2,5X7	T08
X	UDRL 14181	✓	24,5	25	34	131	49	56	SP.. 07T308	M2,5X7	T08
X	UDRL 8066	✓	25	25	34	131	50	56	SP.. 07T308	M2,5X7	T08
X	UDRL 12547	✓	25,5	25	34	134	51	56	SP.. 07T308	M2,5X7	T08
X	UDRL 8067	✓	26	25	34	134	52	56	SP.. 07T308	M2,5X7	T08
X	UDRL 12972	✓	26,5	25	34	136	53	56	SP.. 07T308	M2,5X7	T08
X	UDRL 8068	✓	27	25	34	137	54	56	SP.. 07T308	M2,5X7	T08
X	UDRL 8069	✓	27,5	25	34	140	55	56	SP.. 090408	M3,5X8	T15
X	UDRL 8070	✓	28	25	34	140	56	56	SP.. 090408	M3,5X8	T15
X	UDRL 14253	✓	28,5	25	34	143	57	56	SP.. 090408	M3,5X8	T15
X	UDRL 8071	✓	29	25	34	143	58	56	SP.. 090408	M3,5X8	T15
X	UDRL 14254	✓	29,5	25	34	143	59	56	SP.. 090408	M3,5X8	T15
X	UDRL 8072	✓	30	32	44	150	60	60	SP.. 090408	M3,5X8	T15
X	UDRL 8073	✓	31	32	44	153	62	60	SP.. 090408	M3,5X8	T15
X	UDRL 8074	✓	32	32	44	156	64	60	SP.. 090408	M3,5X8	T15
X	UDRL 8075	✓	33	32	44	159	66	60	SP.. 090408	M3,5X8	T15
X	UDRL 8076	✓	34	32	44	162	68	60	SP.. 110408	M4X11	T15
X	UDRL 8077	✓	35	32	44	165	70	60	SP.. 110408	M4X11	T15
X	UDRL 8078	✓	36	32	44	168	72	60	SP.. 110408	M4X11	T15
X	UDRL 8079	✓	37	32	44	171	74	60	SP.. 110408	M4X11	T15
X	UDRL 8080	✓	38	32	44	174	76	60	SP.. 110408	M4X11	T15
X	UDRL 8081	✓	39	32	44	177	78	60	SP.. 110408	M4X11	T15
X	UDRL 8082	✓	40	32	44	180	80	60	SP.. 110408	M4X11	T15
X	UDRL 8083	✓	41	32	44	183	82	60	SP.. 110408	M4X11	T15
X	UDRL 8084	✓	42	32	44	186	84	60	SP.. 140512	M5X12	T20
X	UDRL 8085	✓	42,5	32	44	189	86	60	SP.. 140512	M5X12	T20
X	UDRL 8086	✓	43	32	44	189	86	60	SP.. 140512	M5X12	T20
X	UDRL 8087	✓	44	32	44	192	88	60	SP.. 140512	M5X12	T20
X	UDRL 8088	✓	45	40	54	195	90	70	SP.. 140512	M5X12	T20
X	UDRL 8089	✓	46	40	54	198	92	70	SP.. 140512	M5X12	T20
X	UDRL 8090	✓	47	40	54	201	94	70	SP.. 140512	M5X12	T20
X	UDRL 8091	✓	48	40	54	204	96	70	SP.. 140512	M5X12	T20
X	UDRL 8092	✓	49	40	54	207	98	70	SP.. 140512	M5X12	T20
X	UDRL 8093	✓	50	40	54	210	100	70	SP.. 140512	M5X12	T20

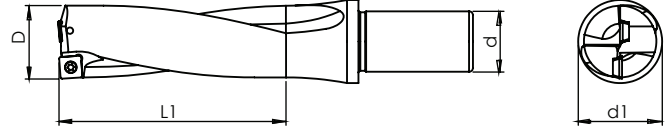
**DRILL SP. D3**

Kesici Uç Uyumluluğu Insert Suitability		Stok Stock	Takım Ölçüleri / Dimension (mm)						Uç Insert	Vida Screw	Anahtar Torx Key
DRILL SP. D3			D	d	d1	L	L1	L2			
SİPARİŞ KODU Ordering Code	SİPARİŞ KODU Ordering Code Inter Coolant										
X	UDRL 12220	✓	12,5	20	25	101	37,5	50	SP.. 050204	M2X5	T06
X	UDRL 8094	✓	13	20	25	101	39	50	SP.. 050204	M2X5	T06
X	UDRL 14255	✓	13,5	20	25	105	40,5	50	SP.. 050204	M2X5	T06
X	UDRL 8095	✓	14	20	25	105	42	50	SP.. 050204	M2X5	T06
X	UDRL 8096	✓	14,5	20	25	109	43,5	50	SP.. 050204	M2X5	T06
X	UDRL 8097	✓	15	20	25	109	45	50	SP.. 050204	M2X5	T06
X	UDRL 8098	✓	15,5	20	25	110	46,5	50	SP.. 050204	M2X5	T06
X	UDRL 8099	✓	16	25	34	126	48	56	SP.. 060204	M2,2X5	T06
X	UDRL 8100	✓	16,5	25	34	129	49,5	56	SP.. 060204	M2,2X5	T06
X	UDRL 8101	✓	17	25	34	129	51	56	SP.. 060204	M2,2X5	T06
X	UDRL 8102	✓	17,5	25	34	132	52,5	56	SP.. 060204	M2,2X5	T06
X	UDRL 8103	✓	18	25	34	132	54	56	SP.. 060204	M2,2X5	T06
X	UDRL 8104	✓	18,5	25	34	135	55,5	56	SP.. 060204	M2,2X5	T06
X	UDRL 8105	✓	19	25	34	135	57	56	SP.. 060204	M2,2X5	T06
X	UDRL 8106	✓	19,5	25	34	139	58,5	56	SP.. 060204	M2,2X5	T06
X	UDRL 8107	✓	20	25	34	139	60	56	SP.. 060204	M2,2X5	T06
X	UDRL 8108	✓	20,5	25	34	143	61,5	56	SP.. 060204	M2,2X5	T06
X	UDRL 8109	✓	21	25	34	143	63	56	SP.. 060204	M2,2X5	T06
X	UDRL 8110	✓	21,5	25	34	147	64,5	56	SP.. 060204	M2,2X5	T06
X	UDRL 8111	✓	22	25	34	147	66	56	SP.. 07T308	M2,5X7	T08
X	UDRL 8112	✓	22,5	25	34	151	67,5	56	SP.. 07T308	M2,5X7	T08
X	UDRL 8113	✓	23	25	34	151	69	56	SP.. 07T308	M2,5X7	T08
X	UDRL 8114	✓	23,5	25	34	153	70,5	56	SP.. 07T308	M2,5X7	T08
X	UDRL 8115	✓	24	25	34	153	72	56	SP.. 07T308	M2,5X7	T08
X	UDRL 8116	✓	24,5	25	34	156	73,5	56	SP.. 07T308	M2,5X7	T08
X	UDRL 8117	✓	25	25	34	156	75	56	SP.. 07T308	M2,5X7	T08
X	UDRL 8118	✓	25,5	25	34	160	76,5	56	SP.. 07T308	M2,5X7	T08
X	UDRL 8119	✓	26	25	34	160	78	56	SP.. 07T308	M2,5X7	T08
X	UDRL 8120	✓	26,5	25	34	164	79,5	56	SP.. 07T308	M2,5X7	T08
X	UDRL 8121	✓	27	25	34	164	81	56	SP.. 07T308	M2,5X7	T08
X	UDRL 8122	✓	27,5	25	34	168	82,5	56	SP.. 07T308	M2,5X7	T08
X	UDRL 8123	✓	28	25	34	168	84	56	SP.. 090408	M3,5X8	T15
X	UDRL 8124	✓	28,5	25	34	172	85,5	56	SP.. 090408	M3,5X8	T15
X	UDRL 8125	✓	29	25	34	172	87	56	SP.. 090408	M3,5X8	T15
X	UDRL 8126	✓	29,5	25	44	180	88,5	56	SP.. 090408	M3,5X8	T15
X	UDRL 8127	✓	30	32	44	180	90	60	SP.. 090408	M3,5X8	T15
X	UDRL 8128	✓	31	32	44	184	93	60	SP.. 090408	M3,5X8	T15
X	UDRL 8129	✓	32	32	44	188	96	60	SP.. 090408	M3,5X8	T15
X	UDRL 8130	✓	33	32	44	192	99	60	SP.. 090408	M3,5X8	T15
X	UDRL 8131	✓	34	32	44	192	102	60	SP.. 110408	M4X11	T15
X	UDRL 8132	✓	35	32	44	200	105	60	SP.. 110408	M4X11	T15
X	UDRL 8133	✓	36	32	44	204	108	60	SP.. 110408	M4X11	T15
X	UDRL 8134	✓	37	32	44	208	111	60	SP.. 110408	M4X11	T15
X	UDRL 8135	✓	38	32	44	212	114	60	SP.. 110408	M4X11	T15
X	UDRL 8136	✓	38,5	32	44	216	115,5	60	SP.. 110408	M4X11	T15
X	UDRL 8137	✓	39	32	44	216	117	60	SP.. 110408	M4X11	T15
X	UDRL 8138	✓	40	32	44	220	120	60	SP.. 110408	M4X11	T15
X	UDRL 8139	✓	41	32	44	223	123	60	SP.. 110408	M4X11	T15
X	UDRL 11414	✓	41,5	32	44	226	124,5	60	SP.. 110408	M4X11	T15
X	UDRL 8140	✓	42	32	44	226	126	60	SP.. 140512	M5X12	T20
X	UDRL 8141	✓	43	32	44	229	129	60	SP.. 140512	M5X12	T20
X	UDRL 8142	✓	44	32	44	232	132	60	SP.. 140512	M5X12	T20
X	UDRL 8143	✓	45	40	54	245	135	70	SP.. 140512	M5X12	T20
X	UDRL 8144	✓	46	40	54	248	138	70	SP.. 140512	M5X12	T20
X	UDRL 8145	✓	47	40	54	251	141	70	SP.. 140512	M5X12	T20
X	UDRL 8146	✓	48	40	54	254	144	70	SP.. 140512	M5X12	T20
X	UDRL 8147	✓	49	40	54	257	147	70	SP.. 140512	M5X12	T20
X	UDRL 8148	✓	50	40	54	260	150	70	SP.. 140512	M5X12	T20
X	UDRL 11415	✓	50,5	40	54	260	150	70	SP.. 140512	M5X12	T20
X	UDRL 16804	✓	51	40	54	263	153	70	SP.. 140512	M5X12	T20
X	UDRL 16805	✓	52	40	54	266	156	70	SP.. 140512	M5X12	T20
X	UDRL 16806	✓	53	40	54	269	159	70	SP.. 140512	M5X12	T20
X	UDRL 16807	✓	54	40	54	271	162	70	SP.. 140512	M5X12	T20

### DRILL SP.. D4

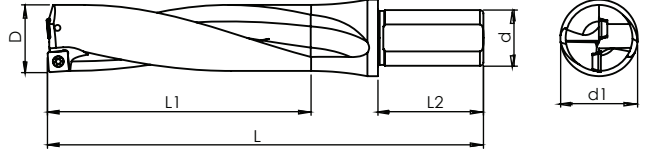

Kesici Uç Uyumluluğu Insert Suitability		Stok Stock	Takım Ölçüleri / Dimension (mm)						Uç Insert	Vida Screw	Anahtar Torx Key
DRILL SP.. D4			D	d	d1	L	L1	L2			
SİPARİŞ KODU Ordering Code	SİPARİŞ KODU Ordering Code Inter Coolant										
X	UDRL 8149	✓	13	20	25	115	52	50	SP.. 050204	M2X5	T06
X	UDRL 8150	✓	14	20	25	119	56	50	SP.. 050204	M2X5	T06
X	UDRL 8151	✓	14,5	20	25	124	60	50	SP.. 050204	M2X5	T06
X	UDRL 8152	✓	15	20	25	124	60	50	SP.. 050204	M2X5	T06
X	UDRL 11417	✓	15,5	20	25	128	62	50	SP.. 050204	M2X5	T06
X	UDRL 8153	✓	16	25	34	142	64	56	SP.. 060204	M2,2X5	T06
X	UDRL 8154	✓	17	25	34	146	68	56	SP.. 060204	M2,2X5	T06
X	UDRL 11963	✓	17,5	25	34	150	52,5	56	SP.. 060204	M2,2X5	T06
X	UDRL 8155	✓	18	25	34	150	72	56	SP.. 060204	M2,2X5	T06
X	UDRL 8156	✓	19	25	34	154	76	56	SP.. 060204	M2,2X5	T06
X	UDRL 8157	✓	19,5	25	34	159	78	56	SP.. 060204	M2,2X5	T06
X	UDRL 8158	✓	20	25	34	159	80	56	SP.. 060204	M2,2X5	T06
X	UDRL 8159	✓	21	25	34	164	84	56	SP.. 060204	M2,2X5	T06
X	UDRL 8160	✓	22	25	34	169	88	56	SP.. 07T308	M2,5X7	T08
X	UDRL 8161	✓	23	25	34	174	92	56	SP.. 07T308	M2,5X7	T08
X	UDRL 14115	✓	23,5	25	34	174	92	56	SP.. 07T308	M2,5X7	T08
X	UDRL 8162	✓	24	25	34	177	96	56	SP.. 07T308	M2,5X7	T08
X	UDRL 8163	✓	23,5	25	34	181	100	56	SP.. 07T308	M2,5X7	T08
X	UDRL 8164	✓	25	25	34	181	100	56	SP.. 07T308	M2,5X7	T08
X	UDRL 8165	✓	26	25	34	186	104	56	SP.. 07T308	M2,5X7	T08
X	UDRL 8166	✓	27	25	34	191	108	56	SP.. 07T308	M2,5X7	T08
X	UDRL 8167	✓	27,5	25	34	191	112	56	SP.. 07T308	M2,5X7	T08
X	UDRL 8168	✓	28	25	34	196	112	56	SP.. 090408	M3,5X8	T15
X	UDRL 8169	✓	29	25	34	201	116	56	SP.. 090408	M3,5X8	T15
X	UDRL 8170	✓	30	32	44	210	120	60	SP.. 090408	M3,5X8	T15
X	UDRL 8171	✓	31	32	44	215	124	60	SP.. 090408	M3,5X8	T15
X	UDRL 8172	✓	32	32	44	220	128	60	SP.. 090408	M3,5X8	T15
X	UDRL 8173	✓	33	32	44	225	132	60	SP.. 090408	M3,5X8	T15
X	UDRL 8174	✓	33,5	32	44	225	136	60	SP.. 090408	M3,5X8	T15
X	UDRL 8175	✓	34	32	44	230	136	60	SP.. 110408	M4X11	T15
X	UDRL 8176	✓	35	32	44	235	140	60	SP.. 110408	M4X11	T15
X	UDRL 8177	✓	36	32	44	238	144	60	SP.. 110408	M4X11	T15
X	UDRL 8178	✓	37	32	44	241	148	60	SP.. 110408	M4X11	T15
X	UDRL 8179	✓	38	32	44	244	152	60	SP.. 110408	M4X11	T15
X	UDRL 8180	✓	38,5	32	44	247	156	60	SP.. 110408	M4X11	T15
X	UDRL 8181	✓	39	32	44	247	156	60	SP.. 110408	M4X11	T15
X	UDRL 11409	✓	39,5	32	44	250	158	60	SP.. 110408	M4X11	T15
X	UDRL 8182	✓	40	32	44	250	160	60	SP.. 110408	M4X11	T15
X	UDRL 8183	✓	41	32	44	253	164	60	SP.. 110408	M4X11	T15
X	UDRL 8184	✓	42	32	44	256	168	60	SP.. 140512	M5X12	T20
X	UDRL 8185	✓	43	32	44	259	172	60	SP.. 140512	M5X12	T20
X	UDRL 8186	✓	44	32	44	262	176	60	SP.. 140512	M5X12	T20
X	UDRL 8187	✓	45	40	54	265	180	70	SP.. 140512	M5X12	T20
X	UDRL 8188	✓	46	40	54	268	184	70	SP.. 140512	M5X12	T20
X	UDRL 8189	✓	47	40	54	271	188	70	SP.. 140512	M5X12	T20
X	UDRL 8190	✓	48	40	54	274	192	70	SP.. 140512	M5X12	T20
X	UDRL 8191	✓	49	40	54	277	196	70	SP.. 140512	M5X12	T20
X	UDRL 8192	✓	50	40	54	280	200	70	SP.. 140512	M5X12	T20
X	UDRL 16808	✓	51	40	54	283	204	70	SP.. 140512	M5X12	T20
X	UDRL 16809	✓	52	40	54	286	208	70	SP.. 140512	M5X12	T20
X	UDRL 16810	✓	53	40	54	289	212	70	SP.. 140512	M5X12	T20
X	UDRL 16811	✓	54	40	54	291	216	70	SP.. 140512	M5X12	T20

## DRILL SP.. D5

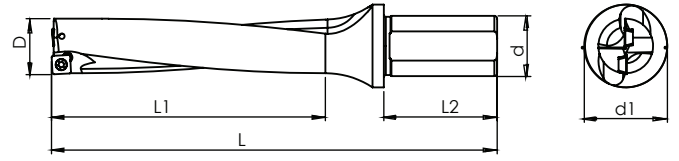

Kesici Uç Uyumluluğu Insert Suitability		Stok Stock	Takım Ölçüleri / Dimension (mm)						Uç Insert	Vida Screw	Anahtar Torx Key
DRILL SP.. D5			D	d	d1	L	L1	L2			
SİPARİŞ KODU Ordering Code	SİPARİŞ KODU Ordering Code Inter Coolant										
X	UDRL 8193	✓	16	25	34	153	80	56	SP.. 060204	M2,2X5	T06
X	UDRL 8194	✓	17	25	34	158	85	56	SP.. 060204	M2,2X5	T06
X	UDRL 8195	✓	18	25	34	163	90	56	SP.. 060204	M2,2X5	T06
X	UDRL 8196	✓	19	25	34	168	95	56	SP.. 060204	M2,2X5	T06
X	UDRL 8197	✓	20	25	34	174	100	56	SP.. 060204	M2,2X5	T06
X	UDRL 8198	✓	21	25	34	180	105	56	SP.. 060204	M2,2X5	T06
X	UDRL 8199	✓	22	25	34	186	110	56	SP.. 07T308	M2,5X7	T08
X	UDRL 8200	✓	23	25	34	192	115	56	SP.. 07T308	M2,5X7	T08
X	UDRL 8201	✓	24	25	34	196	120	56	SP.. 07T308	M2,5X7	T08
X	UDRL 8202	✓	25	25	34	200	125	56	SP.. 07T308	M2,5X7	T08
X	UDRL 8203	✓	26	25	34	206	130	56	SP.. 07T308	M2,5X7	T08
X	UDRL 8204	✓	27	25	34	212	135	56	SP.. 07T308	M2,5X7	T08
X	UDRL 8205	✓	28	25	34	218	140	56	SP.. 090408	M3,5X8	T15
X	UDRL 8206	✓	29	25	34	224	145	56	SP.. 090408	M3,5X8	T15
X	UDRL 8207	✓	30	32	44	233	150	60	SP.. 090408	M3,5X8	T15

## DRILL XOMT - SPMT D2

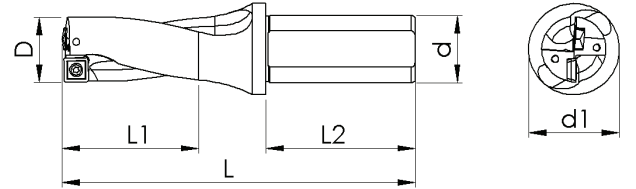
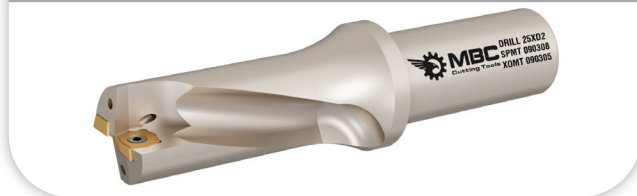

Kesici Uç Uyumluluğu Insert Suitability		Stok Stock	Takım Ölçüleri / Dimension (mm)						Uç Insert	Vida Screw	Anahtar Torx Key
DRILL XOMT - SPMT D2			D	d	d1	L	L1	L2			
SİPARİŞ KODU Ordering Code	SİPARİŞ KODU Ordering Code Inter Coolant										
X	UDRL 11789	✓	16	25	34	110	32	50	SPMT050204 XOMT050204	M2,2X5	T06
X	UDRL 11790	✓	17	25	34	112	34	56	SPMT060205 XOMT060204	M2,2X6	T06
X	UDRL 11791	✓	18	25	34	114	36	56	SPMT060205 XOMT060204	M2,2X6	T06
X	UDRL 11793	✓	19	25	34	116	38	56	SPMT060205 XOMT060204	M2,2X6	T06
X	UDRL 11795	✓	20	25	34	119	40	56	SPMT07T208 XOMT07T205	M3X7	T08
X	UDRL 11796	✓	21	25	34	122	42	56	SPMT07T208 XOMT07T205	M3X7	T08
X	UDRL 11799	✓	22	25	34	125	44	56	SPMT07T208 XOMT07T205	M3X7	T08
X	UDRL 11801	✓	23	25	34	128	46	56	SPMT07T208 XOMT07T205	M3X7	T08
X	UDRL 11811	✓	24	25	34	129	48	56	SPMT090308 XOMT090305	M3X8	T08
X	UDRL 11812	✓	25	25	34	131	50	56	SPMT090308 XOMT090305	M3X8	T08
X	UDRL 11814	✓	26	25	34	134	52	56	SPMT090308 XOMT090305	M3X8	T08
X	UDRL 11816	✓	27	25	34	137	54	56	SPMT090308 XOMT090305	M3X8	T08
X	UDRL 11817	✓	28	25	34	140	56	56	SPMT090308 XOMT090305	M3X8	T08
X	UDRL 11819	✓	29	25	34	143	58	56	SPMT090308 XOMT090305	M3X8	T08
X	UDRL 11820	✓	30	32	44	150	60	60	SPMT11T308 XOMT11T306	M3,5X9	T15
X	UDRL 11821	✓	31	32	44	153	62	60	SPMT11T308 XOMT11T306	M3,5X9	T15
X	UDRL 11825	✓	32	32	44	156	64	60	SPMT11T308 XOMT11T306	M3,5X9	T15
X	UDRL 11827	✓	33	32	44	159	66	60	SPMT11T308 XOMT11T306	M3,5X9	T15
X	UDRL 11828	✓	34	32	44	162	68	60	SPMT11T308 XOMT11T306	M3,5X9	T15
X	UDRL 11829	✓	35	32	44	165	70	60	SPMT11T308 XOMT11T306	M3,5X9	T15



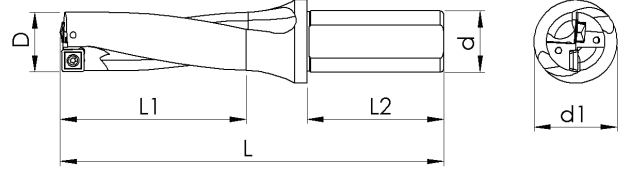

### DRILL XOMT - SPMT D3

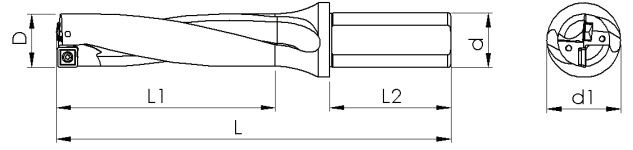
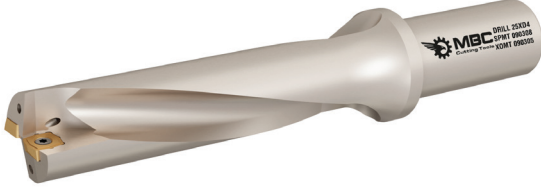

Kesici Uç Uyumluluğu Insert Suitability		Stok Stock	Takım Ölçüleri / Dimension (mm)					Uç Insert	Vida Screw	Anahtar Torx Key	
DRILL XOMT - SPMT D3	SIPARIŞ KODU Ordering Code		D	d	d1	L	L1	L2			
X	UDRL 12542	✓	15	25	34	126	45	56	SPMT050204 XOMT050204	M2,2X5	T06
X	UDRL 11792	✓	16	25	34	126	48	56	SPMT050204 XOMT050204	M2,2X5	T06
X	UDRL 12417	✓	16,5	25	34	126	48	56	SPMT050204 XOMT050204	M2,2X5	T06
X	UDRL 11794	✓	17	25	34	129	51	56	SPMT060205 XOMT060204	M2,2X6	T06
X	UDRL 11906	✓	17,5	25	34	129	51	56	SPMT060205 XOMT060204	M2,2X6	T06
X	UDRL 11797	✓	18	25	34	132	54	56	SPMT060205 XOMT060204	M2,2X6	T06
X	UDRL 11907	✓	18,5	25	34	132	54	56	SPMT060205 XOMT060204	M2,2X6	T06
X	UDRL 11798	✓	19	25	34	135	57	56	SPMT060205 XOMT060204	M2,2X6	T06
X	UDRL 21199	✓	19,5	25	34	135	57	56	SPMT060205 XOMT060204	M2,2X6	T06
X	UDRL 11800	✓	20	25	34	139	60	56	SPMT07T208 XOMT07T205	M3X7	T08
X	UDRL 11802	✓	21	25	34	143	63	56	SPMT07T208 XOMT07T205	M3X7	T08
X	UDRL 21200	✓	21,5	25	34	143	63	56	SPMT07T208 XOMT07T205	M3X7	T08
X	UDRL 11803	✓	22	25	34	147	66	56	SPMT07T208 XOMT07T205	M3X7	T08
X	UDRL 11804	✓	23	25	34	151	69	56	SPMT07T208 XOMT07T205	M3X7	T08
X	UDRL 11805	✓	24	25	34	153	72	56	SPMT090308 XOMT090305	M3X8	T08
X	UDRL 11806	✓	25	25	34	156	75	56	SPMT090308 XOMT090305	M3X8	T08
X	UDRL 11807	✓	26	25	34	160	78	56	SPMT090308 XOMT090305	M3X8	T08
X	UDRL 12457	✓	26,5	25	34	160	78	56	SPMT090308 XOMT090305	M3X8	T08
X	UDRL 11808	✓	27	25	34	164	81	56	SPMT090308 XOMT090305	M3X8	T08
X	UDRL 11809	✓	28	25	34	168	84	56	SPMT090308 XOMT090305	M3X8	T08
X	UDRL 11810	✓	29	25	34	172	87	56	SPMT090308 XOMT090305	M3X8	T08
X	UDRL 11813	✓	30	32	44	180	90	60	SPMT11T308 XOMT11T306	M3,5X9	T15
X	UDRL 11815	✓	31	32	44	184	93	60	SPMT11T308 XOMT11T306	M3,5X9	T15
X	UDRL 11818	✓	32	32	44	188	96	60	SPMT11T308 XOMT11T306	M3,5X9	T15
X	UDRL 11822	✓	33	32	44	192	99	60	SPMT11T308 XOMT11T306	M3,5X9	T15
X	UDRL 11824	✓	34	32	44	192	102	60	SPMT11T308 XOMT11T306	M3,5X9	T15
X	UDRL 11826	✓	35	32	44	200	105	60	SPMT11T308 XOMT11T306	M3,5X9	T15





## DRILL XOMT - SPMT D4

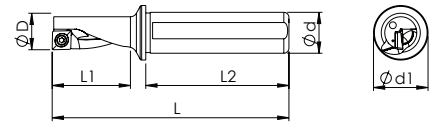
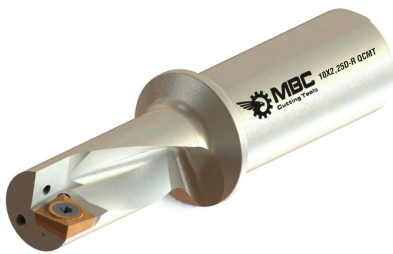

Kesici Uç Uyumluluğu Insert Suitability		Stok Stock	Takım Ölçüleri / Dimension (mm)						Uç Insert		Vida Screw	Anahtar Torx Key
SIPARIŞ KODU Ordering Code	SIPARIŞ KODU Ordering Code Inter Coolant		D	d	d1	L	L1	L2				
X	UDRL 11830	✓	16	25	34	142	64	50	SPMT050204	XOMT050204	M2,2X5	T06
X	UDRL 11831	✓	17	25	34	146	68	56	SPMT060205	XOMT060204	M2,2X6	T06
X	UDRL 17209	✓	17,5	25	34	146	68	56	SPMT060205	XOMT060204	M2,2X6	T06
X	UDRL 11832	✓	18	25	34	150	72	56	SPMT060205	XOMT060204	M2,2X6	T06
X	UDRL 11833	✓	19	25	34	154	76	56	SPMT060205	XOMT060204	M2,2X6	T06
X	UDRL 11834	✓	20	25	34	159	80	56	SPMT07T208	XOMT07T205	M3X7	T08
X	UDRL 21229	✓	20,5	25	34	159	80	56	SPMT07T208	XOMT07T205	M3X7	T08
X	UDRL 11835	✓	21	25	34	164	84	56	SPMT07T208	XOMT07T205	M3X7	T08
X	UDRL 11836	✓	22	25	34	169	88	56	SPMT07T208	XOMT07T205	M3X7	T08
X	UDRL 11837	✓	23	25	34	174	92	56	SPMT07T208	XOMT07T205	M3X7	T08
X	UDRL 11838	✓	24	25	34	177	96	56	SPMT090308	XOMT090305	M3X8	T08
X	UDRL 11839	✓	25	25	34	181	100	56	SPMT090308	XOMT090305	M3X8	T08
X	UDRL 11840	✓	26	25	34	186	104	56	SPMT090308	XOMT090305	M3X8	T08
X	UDRL 11841	✓	27	25	34	191	108	56	SPMT090308	XOMT090305	M3X8	T08
X	UDRL 11842	✓	28	25	34	196	112	56	SPMT090308	XOMT090305	M3X8	T08
X	UDRL 11843	✓	29	25	34	201	116	56	SPMT090308	XOMT090305	M3X8	T08
X	UDRL 11844	✓	30	32	44	210	120	60	SPMT11T308	XOMT11T306	M3,5X9	T15
X	UDRL 11845	✓	31	32	44	215	124	60	SPMT11T308	XOMT11T306	M3,5X9	T15
X	UDRL 11846	✓	32	32	44	220	128	60	SPMT11T308	XOMT11T306	M3,5X9	T15
X	UDRL 11847	✓	33	32	44	225	132	60	SPMT11T308	XOMT11T306	M3,5X9	T15
X	UDRL 11848	✓	34	32	44	230	136	60	SPMT11T308	XOMT11T306	M3,5X9	T15
X	UDRL 11849	✓	35	32	44	235	140	60	SPMT11T308	XOMT11T306	M3,5X9	T15

## ECOCUT



Kesici Uç Uyumluluğu Insert Suitability		Stok Stock	Takım Ölçüleri / Dimension (mm)						Uç Insert		Vida Screw	Anahtar Torx Key
ECOCUT			D	d	d1	L	L1	L2				
X	ECO 16783	✓	10	12	16	69	22,5	42	QC.. 050204		M2X4	T06
X	ECO 16784	✓	12	16	20	77,5	27	45	QC.. 060204		M2,2X5	T06
X	ECO 16785	✓	14	16	20	83	31,5	45	QC.. 070304		M2,5X6	T08
X	ECO 16786	✓	16	20	25	94	36	50	QC.. 080304		M3X8	T10
X	ECO 16788	✓	20	25	32	110	45	56	QC.. 10T304		M3,5X8	T15
X	ECO 16789	✓	25	32	39	130	56,5	60	QC.. 130404		M4,5X11	T20

### MHB - HASSAS BARA

NEW

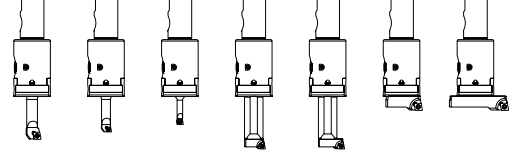
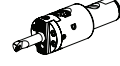
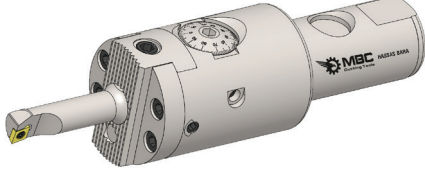

Kesici Uç Uyumluluğu Insert Suitability		Stok Stock	Takım Ölçüleri / Dimension (mm)						Uç İnsert
???	???		Dmin	Dmax	K	L1	L2	L3	
SİPARİŞ KODU - R Ordering Code - R	SİPARİŞ KODU - L Ordering Code - L								
MHB 21294	X	✓	9	130	-	-	-	-	-
MHB 21295	X	✓	-	-	-	-	-	-	-
MHB 21296	X	✓	9	18	34	-	-	-	CCMT 0602
MHB 21297	X	✓	14	24	44	-	-	-	CCMT 0602
MHB 21298	X	✓	22	32	54	-	-	-	CCMT 09T3
MHB 21299	X	✓	28	44	14	-	71	-	CCMT 0602
MHB 21300	X	✓	36	56	14,5	-	71	-	CCMT 0602
MHB 21301	X	✓	50	82	19,5	-	-	95,5	CCMT 09T3
MHB 21302	X	✓	80	130	19,5	-	-	95,5	CCMT 09T3
MHB 21303	X	✓	-	-	-	58	-	-	-

### MKB - KABA BARA

NEW

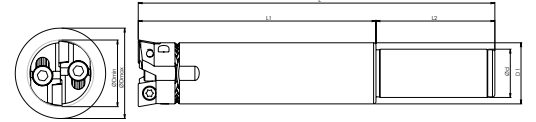

Kesici Uç Uyumluluğu Insert Suitability		Stok Stock	Takım Ölçüleri / Dimension (mm)						Uç İnsert	
MKB - KABA BARA	???		Dmin	Dmax	L1	d	D1	L2	L	
SİPARİŞ KODU - R Ordering Code - R	SİPARİŞ KODU - L Ordering Code - L									
MKB 21304	X	✓	23	28	100	20	21,2	50	150	CCMT 0602
MKB 21305	X	✓	28	38	100	20	25,7	50	155	CCMT 09T3
MKB 21306	X	✓	37	48	95	25	33	56	170	CCMT 09T3
MKB 21307	X	✓	45	56	90	32	40	60	180	CCMT 09T3

**PASO KATERLERİ - STEP CUTTING TOOLS**

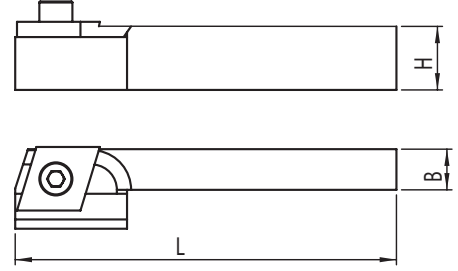

Kesici Uç Uyumluluğu Insert Suitability		Stok Stock	Takım Ölçüleri / Dimension (mm)				Vida Screw	Anahtar Allen Key
PASO KATERLERİ			H	B	L1	L2		
SİPARİŞ KODU - R Ordering Code - R	SİPARİŞ KODU - L Ordering Code - L							
HSS 7254	X	✓	25	17	45	150	M8X25	A6
HSS 7255	X	✓	25	17	45	150	M8X25	A6
HSS 7256	X	✓	25	17	45	150	M8X25	A6
HSS 7257	X	✓	25	17	45	150	M8X25	A6

**KESME KATERLERİ - CUTTING TOOLS**

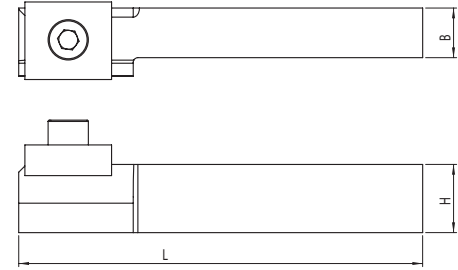
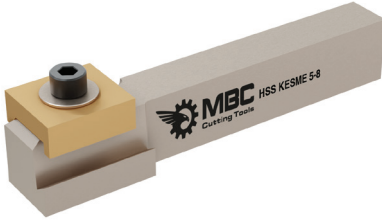

Kesici Uç Uyumluluğu Insert Suitability		Stok Stock	Takım Ölçüleri / Dimension (mm)				Vida Screw	Anahtar Allen Key
KESME KATERLERİ			H	B	L1	L2		
SİPARİŞ KODU - R Ordering Code - R	SİPARİŞ KODU - L Ordering Code - L							
HSS 7253	X	✓	25	17	45	150	M8X25	A6
HSS 7249	X	✓	25	17	45	150	M8X25	A6
HSS 7251	X	✓	25	17	45	150	M8X25	A6
HSS 7250	X	✓	22	16	37	150	M8X25	A6
HSS 7252	X	✓	25	17	46	150	M8X25	A6

**PUNTA KATERİ - PUNTA TOOL**

**NEW**

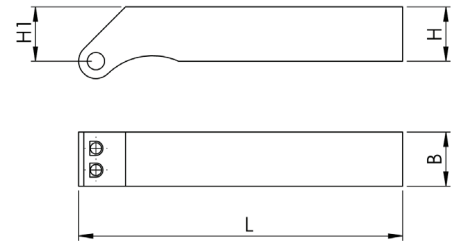

Kesici Uç Uyumluluğu Insert Suitability		Stok Stock	Takım Ölçüleri / Dimension (mm)					Vida Screw	Anahtar Allen Key
PUNTA KATERİ			H1	H	B	L	a		
SİPARİŞ KODU - R Ordering Code - R	SİPARİŞ KODU - L Ordering Code - L								
CNCP 12840	X	✓	20	20	20	125	2,5X6,3	M6 Setur	A2,5
CNCP 12841	X	✓	20	20	20	125	3,15X8	M5 Setur	A2,5
CNCP 15450	X	✓	20	20	20	125	4X10	M5 Setur	A2,5
CNCP 12842	X	✓	25	25	25	150	2,5X6,3	M6 Setur	A2,5
CNCP 12843	X	✓	25	25	25	150	3,15X8	M5 Setur	A2,5
CNCP 15448	X	✓	25	25	25	150	4X10	M5 Setur	A2,5

### TIRTIR TEKLİ - SINGLE TOOLS

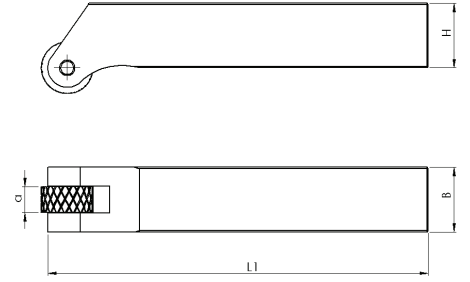

Kesici Uç Uyumluluğu Insert Suitability		Stok Stock	Takım Ölçüleri / Dimension (mm)				Pim Pin
TIRTIR TEKLİ			B	H	a	L	
SİPARİŞ KODU - R Ordering Code - R	SİPARİŞ KODU - L Ordering Code - L						
UT 9688	X	✓	10	10	4	125	4X10
UT 9690	X	✓	12	12	6	125	4X12
UT 9691	X	✓	12	12	6	125	4X12
UT 9705	X	✓	16	16	10	125	6X16
UT 16557	X	✓	16	16	6	125	6X16
UT 9703	X	✓	16	16	6	125	6X16
UT 9704	X	✓	16	16	8	125	6X16
UT 9695	X	✓	20	20	10	125	6X20
UT 9694	X	✓	20	20	8	125	6X20
UT 9697	X	✓	25	25	10	150	6X25
UT 9696	X	✓	25	25	8	150	6X25
CNCT 9708	X	✓	16	16	8	125	6X16
CNCT 9707	X	✓	20	20	10	125	6X20
CNCT 9706	X	✓	25	25	10	150	6X25

### TIRTIR ÇİFTLİ - DOUBLE TOOLS

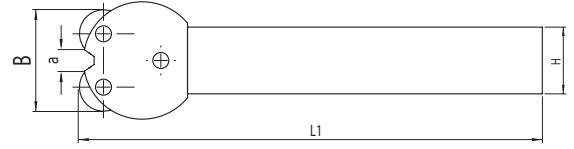

Kesici Uç Uyumluluğu Insert Suitability		Stok Stock	Takım Ölçüleri / Dimension (mm)				Pim Pin
TIRTIR ÇİFTLİ			B	H	a	L	
SİPARİŞ KODU - R Ordering Code - R	SİPARİŞ KODU - L Ordering Code - L						
CNCT 9710	X	✓	22	22	10	150	6X25

### T SOMUN

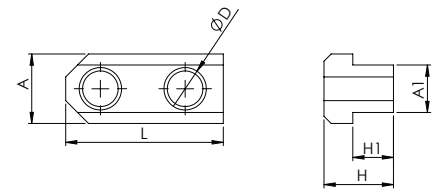

Kesici Uç Uyumluluğu Insert Suitability		Stok Stock	Takım Ölçüleri / Dimension (mm)						
T SOMUN			Ayna Çapı Chuck Dia	L	A	A1	H	H1	d
SİPARİŞ KODU - R Ordering Code - R	SİPARİŞ KODU - L Ordering Code - L								
T-S 14141	X	✓	6"	36	17	12	18,5	11	M10
T-S 14142	X	✓	8"	46,5	20,5	14	20,5	12	M12
T-S 14143	X	✓	10"	51	22,5	16	21,5	13	M12
T-S 14257	X	✓	12"	58	29,5	21	27,5	16	M16

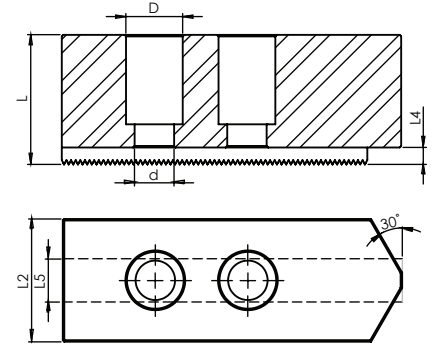
**STANDART YUMUŞAK AYAK**  
**STANDARD SOFT JAWS**

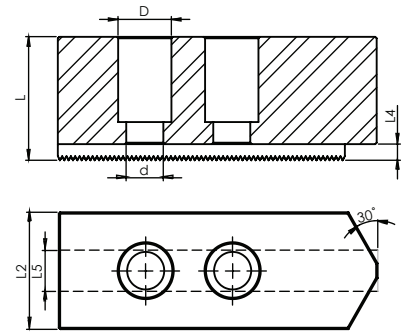

Kesici Uç Uyumluluğu Insert Suitability			Takım Ölçüleri / Dimension (mm)							
STANDART YUMUŞAK AYAK		Stok Stock	Ayna Çapı Chuck Dia	D	d	L	L1	L2	L4	L5
SİPARİŞ KODU - R Ordering Code - R	SİPARİŞ KODU - L Ordering Code - L									
SYA 9558	x	✓	6"	17	10,5	32	72	30	5,5	12
SYA 9556	x	✓	8"	18,5	12,8	37	95	35	5,5	14,15
SYA 9557	x	✓	10"	18,5	12,8	42	110	40	5,5	16,15
SYA 14256	x	✓	12"	25	17	52	130	50	5,5	21

**SİVRİ STANDART YUMUŞAK AYAK**  
**POINTED STANDARD SOFT JAWS**

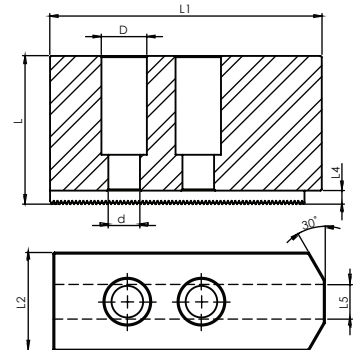
Kesici Uç Uyumluluğu Insert Suitability			Takım Ölçüleri / Dimension (mm)							
SİVRİ STANDART YUMUŞAK AYAK		Stok Stock	Ayna Çapı Chuck Dia	D	d	L	L1	L2	L4	L5
SİPARİŞ KODU - R Ordering Code - R	SİPARİŞ KODU - L Ordering Code - L									
SSYA 16463	x	✓	6"	17	10,5	32	72	30	5,5	12
SSYA 11603	x	✓	8"	18,5	12,8	37	95	35	5,5	14,15
SSYA 11604	x	✓	10"	18,5	12,8	42	110	40	5,5	16,15

**YÜKSEK YUMUŞAK AYAK**  
**HIGH SOFT JAWS**

Kesici Uç Uyumluluğu Insert Suitability			Takım Ölçüleri / Dimension (mm)							
SİVRİ STANDART YUMUŞAK AYAK		Stok Stock	Ayna Çapı Chuck Dia	D	d	L	L1	L2	L4	L5
SİPARİŞ KODU - R Ordering Code - R	SİPARİŞ KODU - L Ordering Code - L									
YYA 11198	x	✓	6"	17	10,5	57	72	30	5,5	12
YYA 11199	x	✓	8"	18,5	12,8	67	95	35	5,5	14,15
YYA 11200	x	✓	10"	18,5	12,8	77	110	40	5,5	16,15
YYA 14258	x	✓	12"	25	17	77	130	50	5,5	21

SİPARİŞ KODU Ordering Code	BASKI CİVATALARI	FİYAT PRICE
YP 11122	 M5X23 A3	
YP 11127	M6X27 A3	
YP 21347	M8X30 A5	

SİPARİŞ KODU Ordering Code	BUKSE VİDA	FİYAT PRICE
YP 11119	 M5X0.5X3.5X11	64,00
YP 11124	M6X0.75X4X11	64,00

SİPARİŞ KODU Ordering Code	BASKI VİDASI	FİYAT PRICE
YP 11123	 M6X0.75	49,00

SİPARİŞ KODU Ordering Code	BASKI VİDASI	FİYAT PRICE
YP 11130	 M8X1 TPKN22	64,00

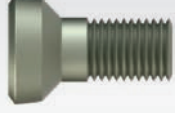
SİPARİŞ KODU Ordering Code	KESME KATER VİDASI	FİYAT PRICE
YP 11118	 M4X12 A3	49,00
YP 14134	M6X16 A5	49,00
YP 11128	M8X27 A4	49,00

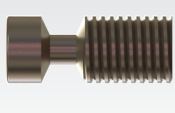
SİPARİŞ KODU Ordering Code	P SİSTEM VİDASI	FİYAT PRICE
YP 11432	 MPV M8 U	98,00
YP 11433	MPV M8 K	98,00

SİPARİŞ KODU Ordering Code	KÜRE TAKIM VİDALARI	FİYAT PRICE
YP 7398	 M3X7 D08	110,00
YP 7399	M4X9 D10	110,00
YP 7400	M5X10 D12	110,00
YP 7401	M5X13 D16	110,00
YP 7402	M5X17 D20	110,00
YP 7403	M6X21 D25	110,00
YP 7404	M8X24 D30	110,00

SİPARİŞ KODU Ordering Code	ALTLIK VİDALARI	FİYAT PRICE
YP 11116	 M3X10	
YP 11117	M4X10	
YP 11120	M5X10	
YP 21346	M5X10 CNMG 16	
YP 14153	M6X10	

SİPARİŞ KODU Ordering Code	TORX VİDALARI	FİYAT PRICE
YP 14154	 M1.8X4.2X2.4	
YP 11168	M2X4	
YP 11169	M2X5	
YP 11161	M2.2X5	
YP 14359	M2.2X6	
YP 11164	M2.5X5	
YP 11165	M2.5X6	
YP 11166	M2.5X7	
YP 11163	M2.5X10	
YP 11177	M3X6	
YP 11178	M3X8 LOGU	
YP 15445	M3X8X4.20	
YP 11176	M3X10	
YP 11174	M3.5X8X4.8	
YP 14198	M3.5X8X5.3	
YP 11171	M3.5X10X5.30	
YP 11172	M3.5X11X4.80	
YP 11175	M3.5X12X5.30	
YP 11173	M3.5X14X5.30	
YP 14360	M3.5X14X4.80	
YP 11187	M4X9	
YP 14361	M4X10X5,8	
YP 11183	M4X11	
YP 11184	M4X14	
YP 11185	M4X16	
YP 11182	M4X16X7 WALTER	
YP 11180	M4.5X12	
YP 11181	M4.5X17	
YP 11188	M5X12	
YP 12642	M5X15	
YP 11189	M5X17	
YP 11190	M6X16	

SİPARİŞ KODU Ordering Code	ALTLIK	Stok Stock
YP 11105		DNMG 11 T SİSTEM ✓
YP 11106		DNMG 15 T SİSTEM ✓
YP 17000		DNMG 11 P SİSTEM ✓
YP 17001		DNMG 15 P SİSTEM ✓

SİPARİŞ KODU Ordering Code	ALTLIK	Stok Stock
YP 11100		CNMG 12 T SİSTEM ✓
YP 11101		CNMG 16 T SİSTEM ✓
YP 11102		CNMG 19 T SİSTEM ✓
YP 17002		CNMG 12 P SİSTEM ✓
YP 17003		CNMG 16 P SİSTEM ✓
YP 17004		CNMG 19 P SİSTEM ✓

SİPARİŞ KODU Ordering Code	ALTLIK	Stok Stock
YP 11152		TNMG 16 T SİSTEM ✓
YP 11153		TNMG 22 T SİSTEM ✓
YP 11150		TNMG 16 M SİSTEM ✓
YP 11151		TNMG 22 P SİSTEM ✓

SİPARİŞ KODU Ordering Code	ALTLIK	Stok Stock
YP 16478		WNMG 06 M SİSTEM ✓
YP 11195		WNMG 08 M SİSTEM ✓
YP 11196		WNMG 08 T SİSTEM ✓
YP 11470		WNMG 08 P SİSTEM ✓

SİPARİŞ KODU Ordering Code	ALTLIK	Stok Stock
YP 11104		DCMT 11 S SİSTEM ✓

SİPARİŞ KODU Ordering Code	ALTLIK	Stok Stock
YP 11192		VBMT 16 S SİSTEM ✓
YP 11194		VNMG 16 T SİSTEM ✓
YP 11193		VCMT 16 S SİSTEM ✓

SİPARİŞ KODU Ordering Code	ALTLIK	Stok Stock
YP 11110		KNUX 16 SAĞ C SİSTEM ✓

SİPARİŞ KODU Ordering Code	ALTLIK	Stok Stock
YP 11111		KNUX 16 SOL C SİSTEM ✓

SİPARİŞ KODU Ordering Code	ALTLIK	Stok Stock
YP 11107		SER 22 - S SİSTEM ✓
YP 11108		SIR 22 - S SİSTEM ✓
YP 11109		SIR-SER 16 ALTLIK SER SEL/SIR SIL ✓

SİPARİŞ KODU Ordering Code	ALTLIK	Stok Stock
YP 11132		SNMG 12 T SİSTEM ✓
YP 11589		SNMG 15 T SİSTEM ✓
YP 11133		SNMG 19 T SİSTEM ✓
YP 17005		SNMG 12 P SİSTEM ✓
YP 17006		SNMG 15 P SİSTEM ✓
YP 17007		SNMG 19 P SİSTEM ✓

SİPARİŞ KODU Ordering Code	ALTLIK	Stok Stock
YP 11097		CCMT 12 - S SİSTEM ✓

SİPARİŞ KODU Ordering Code	ALTLIK	Stok Stock
YP 11149		TCMT 16 S SİSTEM ✓

SİPARİŞ KODU Ordering Code	P SİSTEM LEVYE	Stok Stock
YP 11434		MPL LEVYE DNMG 11-TNMG 16-WNMG 06 ✓
YP 11435		MPL LEVYE CNMG 12-WNMG 08 ✓
YP 17240		MPL LEVYE DNMG 15-TNMG 22 ✓
YP 11436		MPL LEVYE CNMG 16-SNMG 15 ✓
YP 11437		MPL LEVYE CNMG 19-SNMG 19 ✓

SİPARİŞ KODU Ordering Code	P SİSTEM ALTLIK SACI	Stok Stock
YP 11438		MPS 011 ✓
YP 11439		MPS 012 ✓
YP 11440		MPS 016 ✓
YP 11441		MPS 019 ✓

SİPARİŞ KODU Ordering Code	BASKI PABUCU	FİYAT PRICE
YP 11144		T190105 CNMG 19 T SİSTEM 200,00
YP 11145		T190105 SNMG 19 T SİSTEM 200,00

SİPARİŞ KODU Ordering Code	BASKI PABUCU	FİYAT PRICE
YP 11114		M160105 TNMG 16 M 185,00
YP 11115		M220105 TNMG 22 M 185,00

SİPARİŞ KODU Ordering Code	BASKI PABUCU	FİYAT PRICE
YP 11137		T110105 DNMG 11 T SİSTEM 130,00
YP 11143		T110105 TNMG 16 T SİSTEM 130,00
YP 11135		T110105 WNMG 06 T SİSTEM 130,00

SİPARİŞ KODU Ordering Code	BASKI PABUCU	FİYAT PRICE
YP 11091		C110105 SN..12 T 150,00
YP 11139		T120105 CNMG 12 T 130,00
YP 11140		T150105 DNMG 15 T 130,00
YP 11141		T150105 SNMG 15 T 185,00
YP 11146		T220105 TNMG 22 T 165,00
YP 11136		T080105 WNMG08 T 165,00

SİPARİŞ KODU Ordering Code	BASKI PABUCU	FİYAT PRICE
YP 11142		T160105 CNMG 16 T SİSTEM 185,00
YP 9559		T160105 VNMG 16 T SİSTEM 185,00
YP 11141		T150105 SNMG 15 T SİSTEM 185,00

SİPARİŞ KODU Ordering Code	BASKI PABUCU	FİYAT PRICE
YP 11112		M060105 WNMG 06 M SİSTEM 130,00

SİPARİŞ KODU Ordering Code	BASKI PABUCU	FİYAT PRICE
YP 11093		C160105 KNUX 16 SAĞ
YP 11094		C160105 KNUX 16 SOL

SİPARİŞ KODU Ordering Code	BASKI PABUCU	FİYAT PRICE
YP 11098		CK 14 135,00
YP 11099		CK 15 135,00

SİPARİŞ KODU Ordering Code	BASKI PABUCU	FİYAT PRICE
YP 11096		C160105 TPKN 16 135,00

SİPARİŞ KODU Ordering Code	BASKI PABUCU	FİYAT PRICE
YP 11113		M080105 WNMG 08 M SİSTEM 134,00

SİPARİŞ KODU Ordering Code	M SİSTEM ALTLIK PİMİ	FİYAT PRICE
YP 11082		5X3.6X15 PİM TNMG 16 M SİSTEM
YP 21345		5X3.6X12 PİM WNMG 16 M SİSTEM
YP 11083		6X5X15 PİM WNMG 08 TNMG 22 M SİSTEM

SİPARİŞ KODU Ordering Code	BASKI PABUÇ YAYI	FİYAT PRICE
YP 11197		BASKI PABUC YAYI 13,00

SİPARİŞ KODU Ordering Code	BASKI PABUÇ PULU	FİYAT PRICE
YP 11081		10X6X1 mm PUL T-M SİSTEM 13,00

## TORNALAMA İÇİN FORMÜLLER

$$\text{DEVİR SAYISI} = n = \frac{V_c \times 1000}{\pi \times D} \quad \text{devir / dakika}$$

Revolutions / Umdrehungen      Revs / min.  
Umdrehungen / min.

n: Devir Sayısı (dev./dak)  
Revolutions / Umdrehungen      Revs/min.  
Umdrehungen/min.

V<sub>c</sub>: Kesme Hızı (m./dak.)  
Cutting Speed / Schnittgeschwindigkeit (Meter/Min)

$$\text{KESME HIZI} = V_c = \frac{\pi \times D \times n}{1000} \quad \text{metre / dakika}$$

Cutting speed      Revs / min.  
Schnittgeschwindigkeit      Umdrehungen / min.

D: İş Parçasının Çapı (mm)  
Workpiece diameter / Werkstückdurchmesser

π: Sabit Sayı(3,14)  
Constant (3,14) / Gleich bleibend (3,14)

## TORNALAMA İŞLEMİNDE ZAMANININ HESAPLANMASI

$$\text{Çap Tornalamada} = th = \frac{L \times Ps}{n \times f} \quad \text{dakika}$$

Turning diameter / Drehdurchmesser      min.

Ps: Paso Sayısı (kaç defada)  
no of passes / Durchgänge

th: İşleme Zamanı (dakika)  
Processing Time / Bearbeitungszeit (min)

f: İlerleme (mm)  
Length delivery / Stirn Zustellung (min.)

$$\text{Alın Tornalama} = th = \frac{d \times \pi \times L \times Ps}{V_c \times 1000 \times f} \quad \text{dakika}$$

Length turning / Stirn Drehen      min.

Alın Tornalama  
İçin Boy  
Length for face turning / Länge für Stirn Drehen

$$L = \frac{d_1 - d_2}{2} \quad \text{mm}$$

Dolu Malzemede  
Alın Tornalama  
Face turning for solid tool / Massive Werkstücke Stirn Drehen

$$L = \frac{d}{2} \quad \text{mm}$$

## YÜZEY FREZELEMEDE KULLANILAN FORMÜLLER

$$\text{DEVİR SAYISI} = n = \frac{V_c \times 1000}{\pi \times D} \quad \text{devir / dakika}$$

Revolutions / Umdrehungen      Revs / min.  
Umdrehungen / min.

z: Frezenin Ağız Sayısı (adet)  
Number of tooth / Anzahl Schneiden

k: Disk Frezenin Efektif Ağız sayısı (adet)  
Effective edge of the cutter / Effektive Schneiden des Fräasers

$$\text{KESME HIZI} = V_c = \frac{\pi \times D \times n}{1000} \quad \text{metre / dakika}$$

Revolutions / Umdrehungen      Revs / min.  
Schnittgeschwindigkeit      Umdrehungen / min.

fz : Ağız başına ilerleme (mm/ağız)  
Delivery per cutting mm /Z/ Zustellung pro Schneide mm/Z

th: İşleme Zamanı (dak.)  
Processing time / Bearbeitungszeit minute

$$\text{TABLA İLERLEMESİ} = Vf = n \times z \times fz \quad \text{mm/ dak}$$

Delivery / Zustellung      mm / min.

Ps : Paso Sayısı  
Number of passes / Anzahl der Durchgänge

# PLASMA NITRATION

## Nedir?

Vasıflı çelik malzemelerde uygulanabilen bir yüzey sertleştirme yöntemidir. İşlem için özel tasarlanmış vakum fırınlarında, elektrik akımı vasıtasıyla proses gazlarının iyonize edilerek iş parçalarına yönlendirilmesi sayesinde gerçekleşir.

## What Is It?

It is surface hardening method which can be applied inskilled steel materials. The procedre takes place inspecial designed vacuum furnaces by means of electric current in ionizing the process gases and directing them to workpieces.

## Avantajlar

- Aşınma direncini artırır.
- Yorulma ömrünü uzatır.
- Çarpılma riski minimum düzeydedir.
- Yüksek yüzey sertliği sağlar.
- Ölçü hassasiyeti yüksektir.
- Korozyon direncini artırır.
- Temiz ve parlak yüzeyler elde edilir.
- Sertlik dağılımı homojendir.
- Çevreyi kirlilemez.
- Çalışan sağlığına zarar vermez.

## Advantages

- Increases wear resistance.
- Extends fatigue life.
- The risk of distortion is minimal.
- Provides high surface hardness.
- Measurement accuracy is high.
- Increases corrosion resistance.
- Clean and shiny surfaces are obtained.
- Hardness distribution is homogeneous.
- Does not pollute the environment.
- Does not harm employee health.

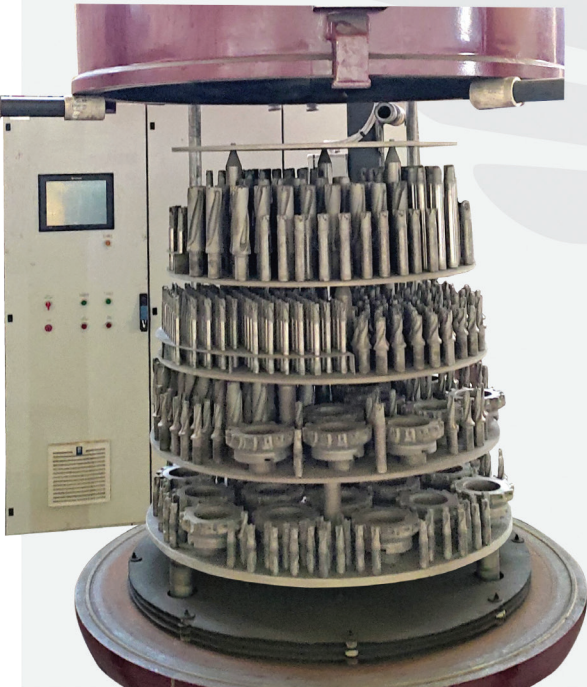





Organize Sanayi Bölgesi 40. Sok. No:19 BURDUR



T. +90 248 252 81 15 - 252 81 65 F. +90 248 252 99 37



info@baydarlar.com - info@mbckesicitakim.com



www.baydarlar.com